



**VRV**

**R-410A**

Heat Pump / Heat Recovery 50 Hz



# Offers a wide variety of new functions that benefit everyone involved

First launched in Japan in 1982, the Daikin VRV system has been embraced by world markets for almost 40 years. Daikin proudly introduces the advanced VRV system. We provide higher benefits to various users related to air conditioning systems, for example, building owners, consultants, installers and even building management.



## Contents

New Products Information	3	
VRV Development History	7	
VRV User Benefits	9	
VRV Overview	13	
VRV R Series	17	
VRV H Series	39	
VRV S High Seasonal Efficiency Series	57	
VRV IV S Series	69	
VRV IV Q Series	77	
VRV IV W Series	93	
VRV WS Series	107	
Indoor Unit Overview	115	
<b>VRV Indoor Units</b>	<b>Type</b>	
FXFTQ-A	Round Flow Cassette with Sensing and Streamer	117
FXFSQ-A	Round Flow Cassette with Sensing	123
FXFQ-A	Round Flow Cassette	129
FXZQ-B	Compact Multi Flow Cassette	133
FXCQ-B	Double Flow Cassette	135
FXEQ-A	Single Flow Cassette	137
FXDQ-PD/ND	Slim Duct (Standard)	139
FXDQ-T	Slim Duct (Compact)	141
FXSQ-PA	Middle Static Pressure Duct	143
FXDYQ-MA	Middle Static Pressure Duct	145
FXMQ-PA	Middle-High Static Pressure Duct	147
FXMQ-P	High Static Pressure Duct	149
FXUQ-A	4-Way Flow Ceiling Suspended	151
FXHQ-MA/B	Ceiling Suspended	153
FXAQ-A	Wall Mounted	155
FXLQ-MA	Floor Standing	157
FXNQ-MA	Concealed Floor Standing	158
BSQ-A,BS-Q14B/A	BS Units	159
Air Handling Unit		163
Air Treatment Equipment		165
Control Systems		183
Option		199
Engineering Supports		217

\*VRV is a trademark of Daikin Industries, Ltd.

For OWNERS



Lifecycle Cost & Comfort

For INSTALLERS



Easy Installation

For CONSULTANTS



Flexible Design & Engineering Supports

For BUILDING MANAGERMENTS



Reliability & Comfort



# New Products Information

## VRV R SERIES Heat Recovery

Page 17



VRV R Series Promotion Movie



VRV R Series Special Site

## VRV H SERIES Heat Pump

Page 39



VRV H Series Promotion Movie



VRV H Series Special Site

### Featuring unique functions in a new large capacity casing

- ✓ Adopt a new casing to realise a single module of up to 24 class
- ✓ Achieved significant energy savings with improved technology
- ✓ Defrost functions improved comfort by extending the heating operation time
- ✓ Design flexibility is further improved by simultaneous extension of height difference and equivalent length.
- ✓ Sealed electrical component box (IP55) blocks the ingress of debris or water, that leads to unexpected failures.
- ✓ A new electrical component service window on the front panel allows easy access to the main board without removing the front panel.
- ✓ Equipped with various new functions, the new model shows a significant improvement in total performance.



REYQ-B  
RXYQ-B



## Round Flow Cassette with Sensing and Streamer Type

Page 117

Comfort, energy savings by sensing functions and enhanced maximum efficiency in cleaning

- ✓ Built-in streamer function unit for efficient cleaning function
- ✓ Daikin advanced sensing technology dual sensors
- ✓ Individual airflow direction control



FXFTQ-A

## Outdoor-Air Processing Unit

Page 169

### FXMQ-AF Series

Improve IAQ with fresh air ventilation and precise room temperature control

- ✓ Set point temperature can be selected similar to standard VRV indoor unit.
- ✓ Maximum connection ratio increased from 100% to 130%.
- ✓ With the VRT control feature, higher efficiency can be achieved.

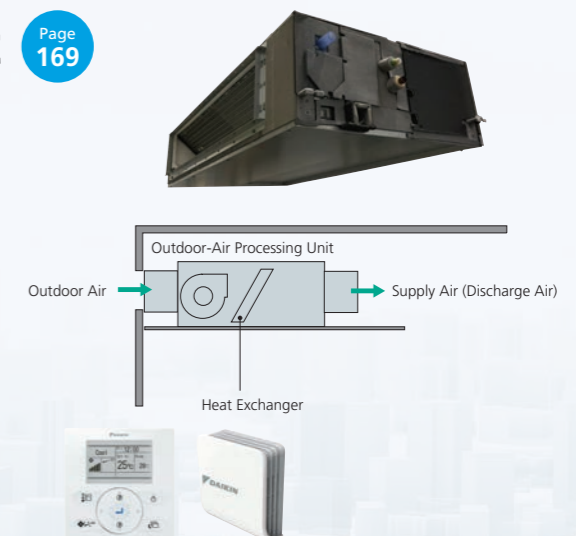

## Stylish Remote Controller

Page 183



Special Site

A complete redesigned controller focused to enhance user experience



White  
BRC1H63W



Black  
BRC1H63K



- ✓ Two attractive colors to match any interior
- ✓ Compact, measures only 85 x 85 mm
- ✓ Timer functions (OFF timer, Weekly schedule timer)
- ✓ Easy setting via smartphone application using Bluetooth® wireless technology (for Installer/Facility manager)
- ✓ Improved setback function to keep hotel room comfortable



Bluetooth



# New Products Information

## Improving air quality with technology

### Introducing Streamer technology to a wide variety of indoor units

Daikin Streamer technology enhances maximum efficiency in cleaning, which uses powerful decomposition properties to decompose substances captured by filter for better air quality.

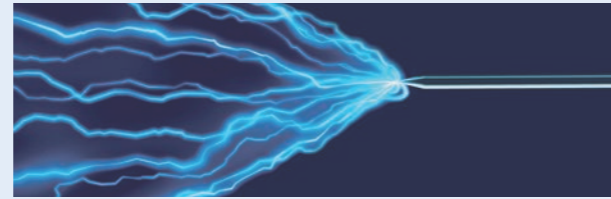

### Built-in inside the indoor unit

Round Flow Cassette with Sensing and Streamer

Page 117



FXFTQ-A



Streamer filter clean unit built-in inside the indoor unit

### Option for the indoor unit

Compact Multi Flow Cassette

Page 133

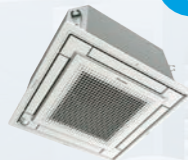

FXZQ-B

Double Flow Cassette

Page 135



FXCQ-B

Ceiling Suspended

Page 153



FXHQ-B



New Option

Streamer Filter Clean Unit BAPWS55A61

## Streamer Technology

Equipped with decomposition technology, Streamer is a type of plasma discharge that eliminates allergens such as pollen, mould, and mites, as well as, deodorises anti-bacterial dust filters so you can breathe with ease.



### Mechanism of decomposition by Streamer

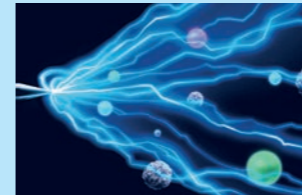

Streamer emits high-speed electrons.

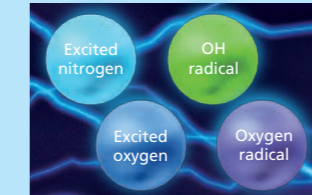

The electrons collide and combine with nitrogen and oxygen in the air to form four kinds of decomposing elements with decomposition power.

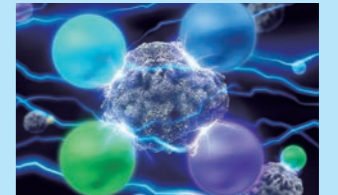

The decomposing elements provide decomposition power.

### 99.93% Inactivation of Omicron variant in 2 hours

#### Experimental Results

Irradiation with Streamer discharge for two hours inactivated 99.93%, and for four hours inactivated 99.97% of the Omicron variant of Coronavirus (SARS-CoV-2), when compared to without Streamer discharge.

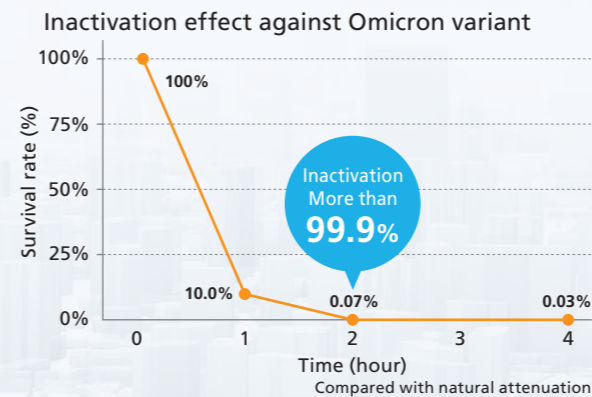

#### Test Method

hCoV-19/Japan/ TY38-873/2021 strain (Omicron variant) was used. Two acrylic boxes of about 31L were placed in a safety cabinet in the BSL-3 facility, and Streamer discharge device was installed in one of the acrylic boxes. Seesaw shakers with a 6-well plate were placed in both boxes, and 0.5 mL of virus solution was placed in each well of the plate. Streamer irradiation was performed on one 6-well plate while stirring with a seesaw shaker. After 1, 2, and 4 hours, the virus solution was collected, and the virus titer was measured by the TCID50 method using Vero E6/TMPRSS2 cells.



#### Test Organization

Professor Tatsuo Shioda, Department of Virus Infections, Research Institute for Microbial Diseases, Osaka University

\*This result was obtained by using a Streamer discharge device for testing in lab conditions. The effect of products equipped with Streamer technology or results in actual use environments may differ.

### Streamer decomposes mould and mites (feces and carcasses) and suppresses the causes of allergies.

#### Demonstration of mould

Picture of mould

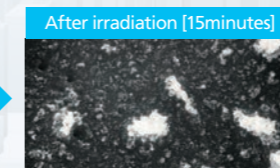

#### Test Method

"Moulds" were placed on the electrodes of a Streamer discharge unit where they were exposed to Streamer discharge for 15 minutes and photographed with an electron microscope.

#### Test Organization

Demonstration test was performed at Wakayama Medical University.

### Why Daikin Streamer?

Recognized as clean technology by public bodies

Winner of the 2005 Progress Award, Institute of Electrostatics Japan  
Awarded for the development of a domestic air purifier which uses DC Streamer discharge.

105 Patents Acquired  
Patents acquired relating to Streamer technology

Streamer, a type of plasma discharge, decomposes hazardous chemical substances. The decomposition power is comparable to thermal energy of about 100,000°C.\*

Note:  
\*Comparison of oxidation decomposition. This does not mean temperature will become high.

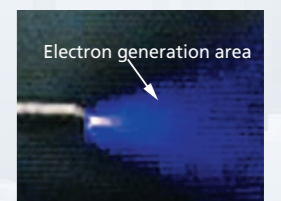



# VRV Development History

To meet the needs of the times, we've been continuously developing technologies as the leading air conditioning manufacturer in the world.



\*VRV is a trademark of Daikin Industries, Ltd.

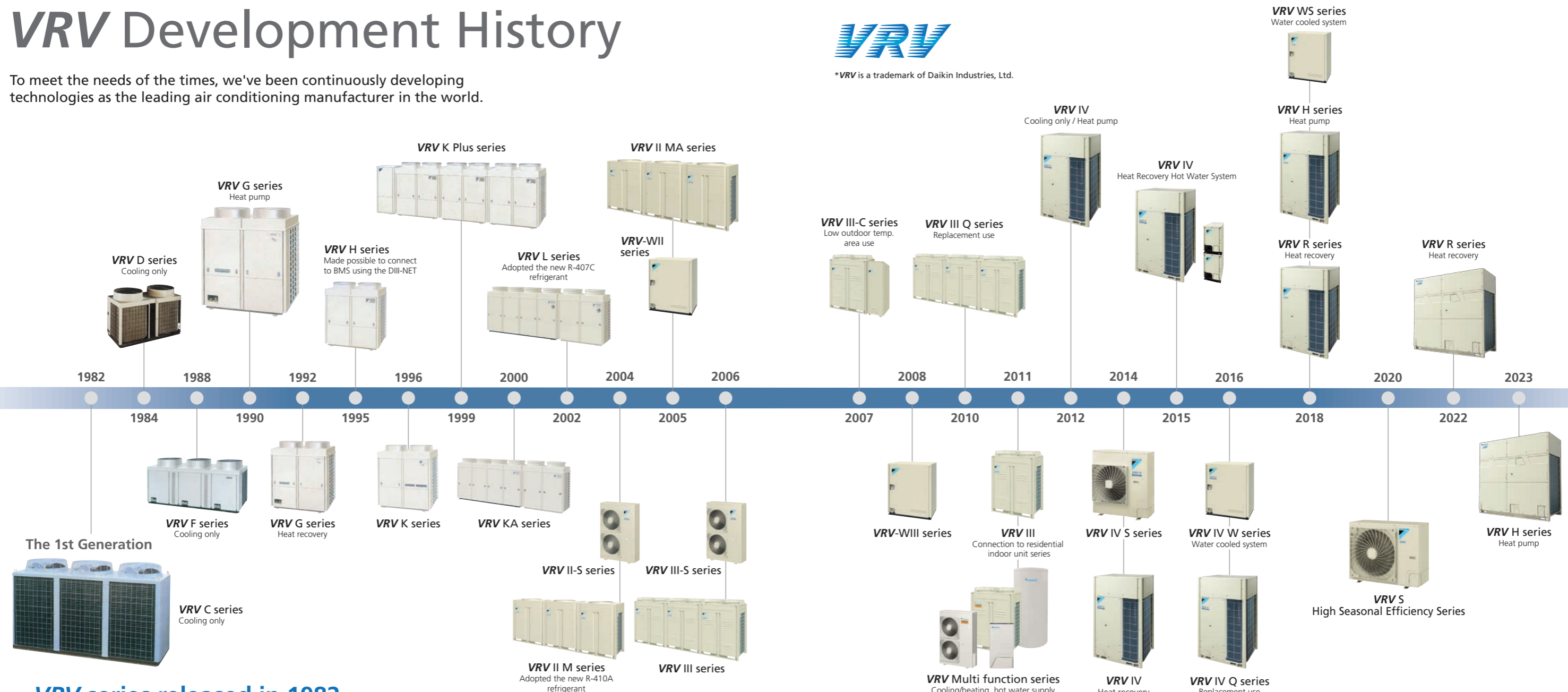

## VRV series released in 1982

The birth of innovative products that changed the history of air conditioning technology

- 2.5-year development term
- Completion of development in May, 1982
- Technical award of Japan Society of Refrigerating & Air-conditioning Engineers in 1983

## Expansion of the country of sale

Sales companies well established in more than 70 countries





 For OWNERS



## Lifecycle Cost & Comfort

### Large-capacity Single Module

- Installation space and cost are reduced by large-capacity casing for max. 24 class.



### Energy Saving Technology

- Further improvement of energy saving by high efficiency compressor and VRT Smart II control.
- Achieves high TCSPF/HSPF, that reduces running cost.



### Comfort

- Defrost operation before the equipment is shut down speeds up the increase of discharge air temperature of the next heating operation.
- If defrost operation time is short, the system will optimise defrost conditions, extending the heating operation time.

### Efficient Space Utilisation

- When construct a large-scale air conditioning system on a single refrigerant system, space for air conditioning is drastically reduced.
- Even with a 20-storey building all of the outdoor units can be installed on the rooftop.

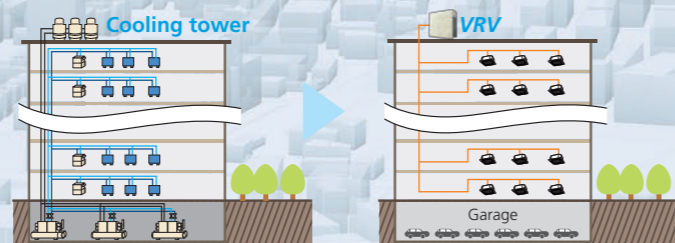

 For CONSULTANTS



## Flexible Design & Engineering Supports

### Long Refrigerant Piping

- Equivalent length extension max. 190 m
- Height difference extension max. 110 m (20 m longer than conventional models)
- By applying for both extensions at the same time, supports a wide range of applications.

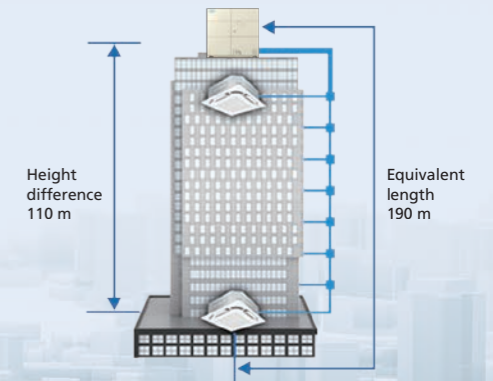

### Engineering Support Software

- Strongly supports for facility design, offering model selection assistance, energy saving and IEQ simulations, drawing support, etc.

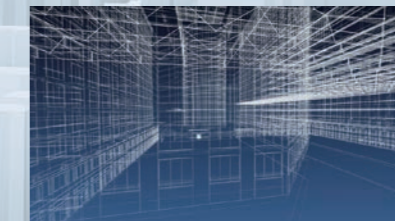
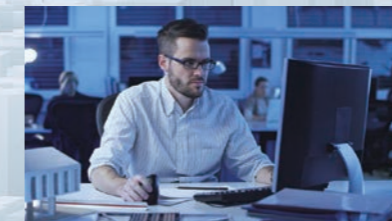

- Model Selection
- Drawing Supports
- Analysis and Simulation

### Varied Lineup of Indoor Units

- With various types of indoor units available, comfortable airflow is ensured in every space.





 For INSTALLERS



## Easy Installation

### Slimmer Main Piping

- For gas pipe of up to 20 class, the main piping diameter size can be reduced from standard size. It enables lowering installation cost.

### Electrical Component Service Window

- Easy access to the main PCB without removing the front panel.
- Quick field setting and trial operation.

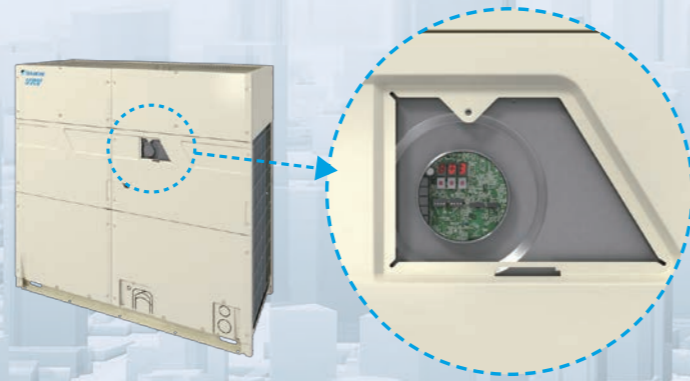

### Process visualization (Test run only)

- A progress rate (0% to 99%) is indicated on the PC board for Easy arrangement for on-site work.



### Simple Piping, Easy Wiring

- The REFNET piping system and DIII-NET system simplify refrigerant piping and control wiring installation.

 For BUILDING MANAGERMENTS



## Reliability & Comfort

### IP55 Sealed Component Box

- Sealed electrical component box (IP55) blocks the ingress of debris or water, that leads to unexpected failures.

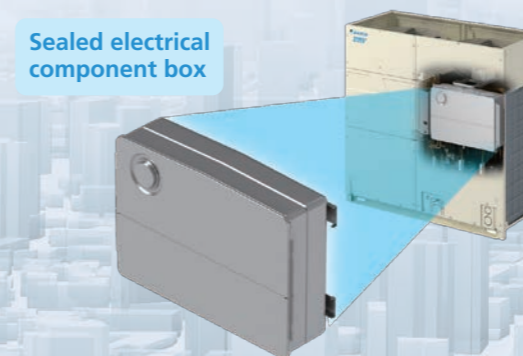

### Refrigerant Piping Cooling System

- Refrigerant cooling circuit enables operation in high outdoor temperatures.

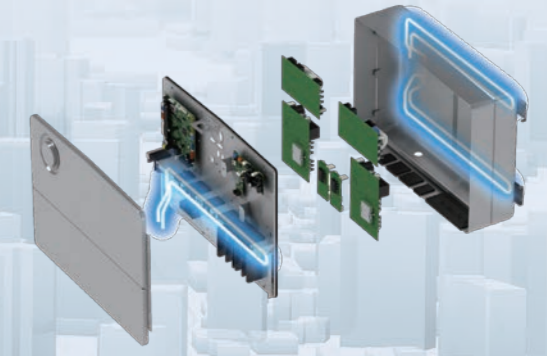

### Double Backup Operation Functions

- Unit backup & Compressor backup ensure continuous operation.

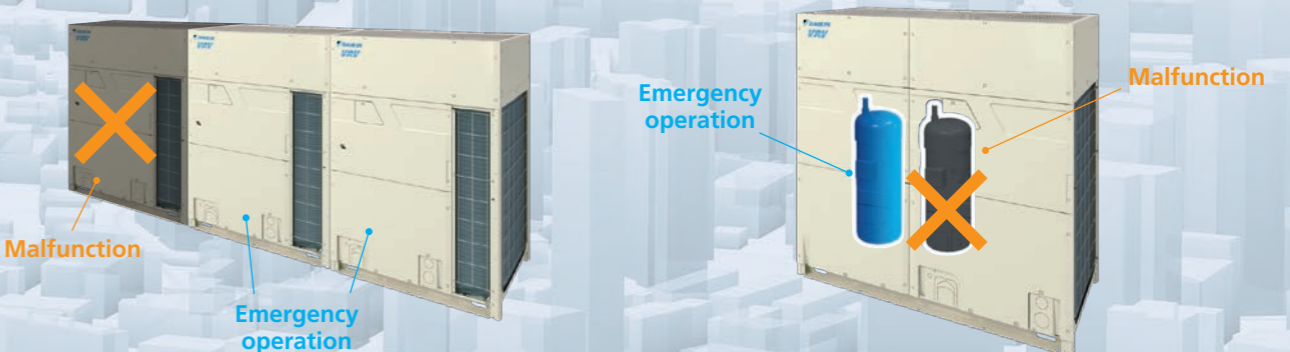



# Wide Variety of Series Models to Supply Total Air Solutions

From residential houses to large buildings, and from newly constructed to renovated buildings, **VRV** system meets a wide range of air conditioning needs and supplies total air solutions.

**VRV R SERIES** Heat Recovery

**REYQ-B**  
3-phase 4-wire system, 380-415 V/380 V, 50/60 Hz

Page 17

Featuring unique functions in a new large capacity casing

The **VRV R** series enables simultaneous operation of cooling and heating within a single refrigerant circuit. By utilising advanced technologies, **VRV R** series achieves further valuable functions.

Lineup

class	8	10	12	14	16	18	20	22	24	26	28	30	32	34	36	38	40	42	44	46	48	50	52	54	56	58	60
Single outdoor units	●	●	●	●	●	●	●	●	●																		
Double outdoor units										●	●	●	●	●	●	●	●	●	●	●	●	●					
Triple outdoor units																						●	●	●	●		

**VRV IV Q SERIES** Heat Pump

**RQYQ-T**  
3-phase 4-wire system, 380-415 V, 50 Hz

Page 77

For quick & high quality replacement use

**VRV III-Q** Heat Recovery  
**RQCEQ-P**  
3-phase 4-wire system, 380-415 V, 50 Hz

**VRV IV Q** series / **VRV III Q** series, a replacement **VRV** unit, can be installed using existing refrigerant piping, so renovation of the air conditioning system can be carried out quickly and smoothly. This minimises inconveniences to activities and users in the building.

Lineup

class		6	8	10	12	13	14	16	18	20	22	24	26	28	30	32	34	36	38	40	42	44	46	48
<b>VRV IV Q</b> series	Heat Pump	●	●	●	●	●	●	●	●	●	●	●	●	●	●	●	●	●	●	●	●	●	●	●
	Space Saving Type																							
<b>VRV III Q</b> series	Heat Recovery		●		●		●		●		●		●		●		●		●		●		●	

**VRV H SERIES** Heat Pump

**RXYQ-B**  
3-phase 4-wire system, 380-415 V/380 V, 50/60 Hz

Page 39

Significant improvement in total performance

The **VRV H** series unites a variety of advanced technologies in providing high efficiency and comfort to cooling and heating.

Lineup

class	8	10	12	14	16	18	20	22	24	26	28	30	32	34	36	38	40	42	44	46	48	50	52	54	56	58	60
Single outdoor units	●	●	●	●	●	●	●	●	●																		
Double outdoor units										●	●	●	●	●	●	●	●	●	●	●	●	●					
Triple outdoor units																							●	●	●	●	

**VRV IV W SERIES** Heat Pump / Heat Recovery

**RWEYQ-T(2)**  
3-phase 4-wire system, 380-415 V/380 V, 50/60 Hz

Page 93

Water cooled system suitable for tall multi-storied buildings

Water cooled **VRV IV W** series utilises water as a heat source. The temperature of heat source water can be from 10°C to 45°C, and outdoor air temperature does not affect cooling capacity. The outside unit is compact and saves space in the machine room.

Lineup

class	6	8	10	12	14	16	18	20	22	24	26	28	30	32	34	36
Heat Pump	●	●	●	●	●	●	●	●	●	●	●	●	●	●	●	●
Heat Recovery	●	●	●	●	●	●	●	●	●	●	●	●	●	●	●	●

**VRV S High Seasonal Efficiency SERIES** Heat Pump

**RSUYQ-A(2)**  
4-6 class: 1-phase, 220-240 V/220-230 V, 50/60 Hz  
7-8 class: 3-phase, 380-415 V/380 V, 50/60 Hz

Page 57

Especially designed for residential houses, small office and shops

**VRV S** High Seasonal Efficiency series achieves higher energy efficiency with a variety of function for comfort and high performance. A wide range of options for installation location and application are easily achieved by the low height casing, long piping length and other features.

Lineup

class	4	5	6	7	8
Heat Pump	●	●	●	●	●

**VRV WS SERIES** Heat Pump

**RWXYQ-A**  
1-phase, 220V, 50Hz

Page 107

Water cooled system suitable for residential houses

Water cooled **VRV WS** series outside units are designed to be compact and lightweight, and single phase power supply enables simplified installation in residential applications.

Lineup

class	3	4	5	6
Heat Pump	●	●	●	●

**VRV IV S SERIES** Heat Pump

**RXYMQ-A(2)/B2**  
3-4 class: 1-phase, 220-230 V, 50 Hz  
5-6 class: 1-phase, 220-240 V/220-230 V, 50/60 Hz  
8-9 class: 3-phase, 380-415 V, 50 Hz

Page 69

Especially designed for residential houses, small offices and shops

**VRV IV S** series aims to provide sufficient capacity, along with the compact size required by residential houses, small offices and shops. Outdoor units are designed to be slim and space saving, and offer 6 models to suit your needs.

Lineup

class	3.5	4	5	6	8	9
Heat Pump	●	●	●	●	●	●

















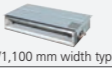





# Wide Range Indoor Unit Lineup

## Create Comfortable Airflow

### VRV indoor units

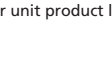
 New lineup

Category	Type	Model Name	Capacity Range (kW)	Capacity Index																			
				20	25	32	40	50	63	71	80	100	125	140	145	160	180	200	250				
				2.2	2.8	3.6	4.5	5.6	7.1	8	9	11.2	14	16	16.2	18	20	22.4	28				
Ceiling Mounted Cassette	Round Flow Cassette with Sensing and Streamer <b>New</b>	<b>FXFTQ-AVM</b>			●	●	●	●	●			●	●	●	●								
	Round Flow Cassette with Sensing	FXFSQ-AVM			●	●	●	●	●			●	●	●	●								
	Round Flow Cassette	FXFQ-AVM			●	●	●	●	●			●	●	●	●								
	Compact Multi Flow Cassette <b>New</b>	<b>FXZQ-BVM</b>			●	●	●	●	●														
	Double Flow Cassette <b>New</b>	<b>FXCQ-BVM</b>			●	●	●	●	●			●	●										
	Single Flow Cassette	FXEQ-AV36			●	●	●	●	●														
Ceiling Concealed Duct	Slim Duct (Standard)	FXDQ-PDVE	 <small>(700 mm width type)</small>		●	●	●																
		FXDQ-NDVE	 <small>(900/1,100 mm width type)</small>					●	●	●													
	Slim Duct (Compact)	FXDQ-TV1C(A)			●	●	●	●	●														
	Middle Static Pressure Duct	FXSQ-PAVE			●	●	●	●	●			●	●	●	●								
		FXDYQ-MAV1										●	●	●	●								
	Middle-High Static Pressure Duct	FXMQ-PAVE			●	●	●	●	●			●	●	●	●								
	High Static Pressure Duct	FXMQ-PV1A													●	●	●	●					
	Outdoor-Air Processing Unit	FXMQ-MFV1											●						●	●			
		<b>FXMQ-AFVM</b>											●			●			●	●			
Ceiling Suspended	4-Way Flow Ceiling Suspended	FXUQ-AVEB								●		●											
	Ceiling Suspended <b>New</b>	<b>FXHQ-BVM</b>													●	●							
Wall Mounted	FXAQ-AVM			●	●	●	●	●															
Floor Standing	Floor Standing	FXLQ-MAVE			●	●	●	●	●														
	Concealed Floor Standing	FXNQ-MAVE			●	●	●	●	●														
Heat Reclaim Ventilator	VAM-HVE		Airflow rate 150-2000 m³/h																				
Air Handling Unit	AHUR		6-60 class																				

Note: For indoor units connectivity, please refer to the indoor unit product lineups under individual outdoor unit series.

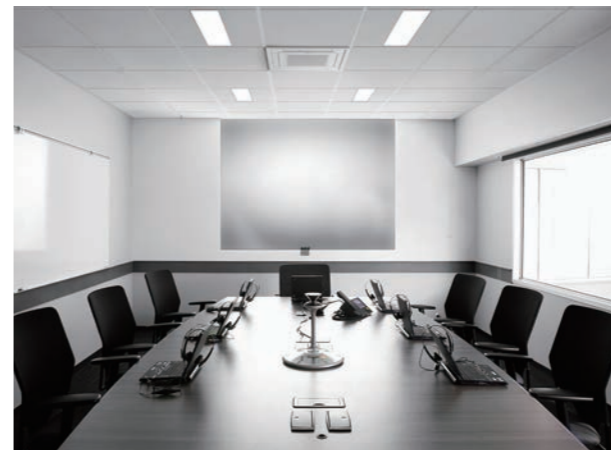



# VRV R SERIES

Featuring unique functions  
in a new large capacity casing

Heat Recovery  
8class—60class  
(22.4 kW) (168 kW)



Promotion Movie



Special Site

New



Single outdoor units  
**REYQ8-24BYM9**

Double outdoor units  
**REYQ26-48BYM9**

Triple outdoor units  
**REYQ50-60BYM9**

Offers a wide variety of new functions that benefit everyone involved.

VRV R series enables flexibility through simultaneous cooling and heating operation with a single VRV system. By recovering heat, it is possible significantly to reduce power consumption. VRV R series adopt a new casing to realise a single module of up to 24 class. In addition, the new models have achieved significant energy savings with improved technology. The operating performance has been improved in all directions by introducing unique ideas, technologies and a wide variety of functions to strengthen design flexibility, easy installation and reliability. We provide higher benefits to various users related to air conditioning systems, for example, building owners, consultants, installers and even building management.

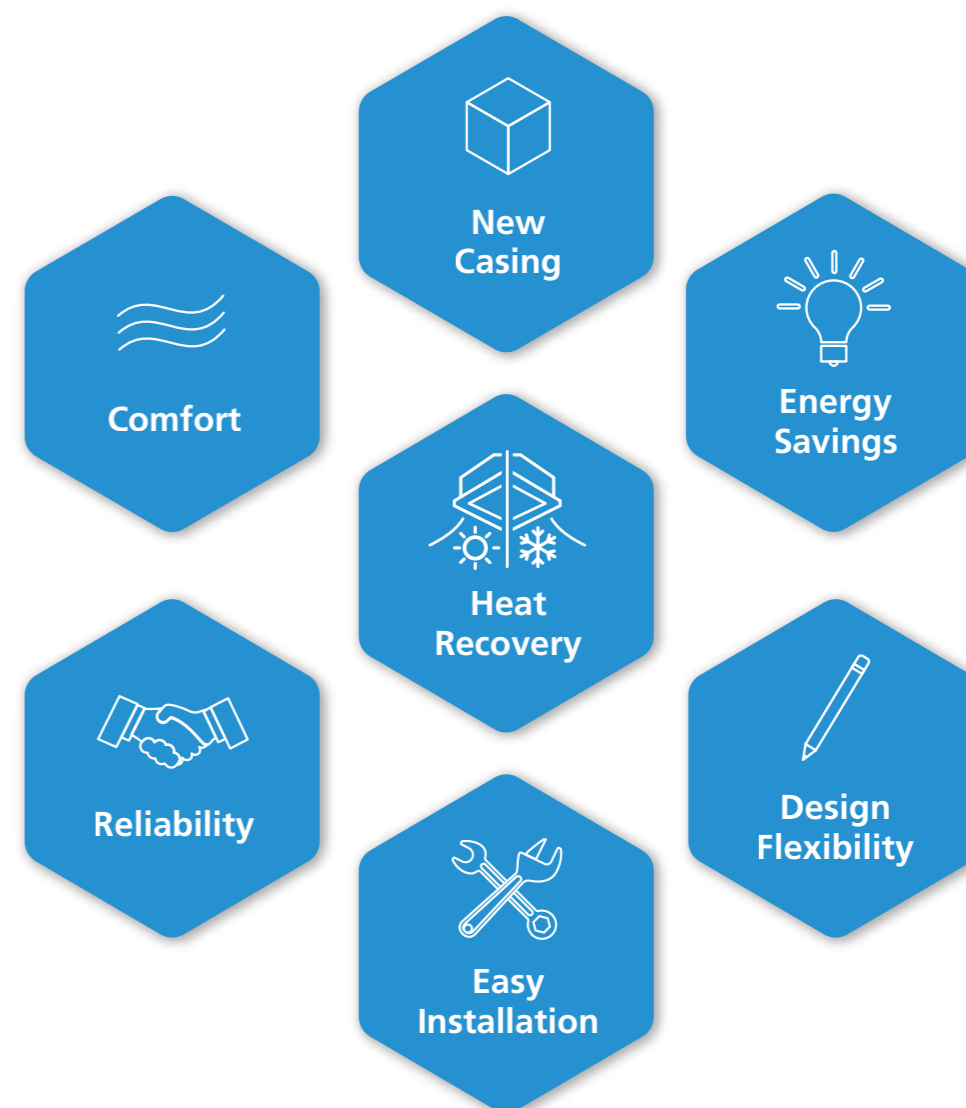



# Heat Recovery Technologies

## VRV R series enables flexibility through simultaneous cooling and heating operation with a single VRV system.

### Situation

Recent office buildings are highly airtight and due to the use of computers, lighting equipment and other office equipments, **cooling load increases even in winter.**

### Need

These buildings require **flexible cooling and heating operation.**

### Solution

- VRV R series enables flexibility through simultaneous cooling and heating operation with a single VRV system.
- Improves energy efficiency by recycling waste heat.

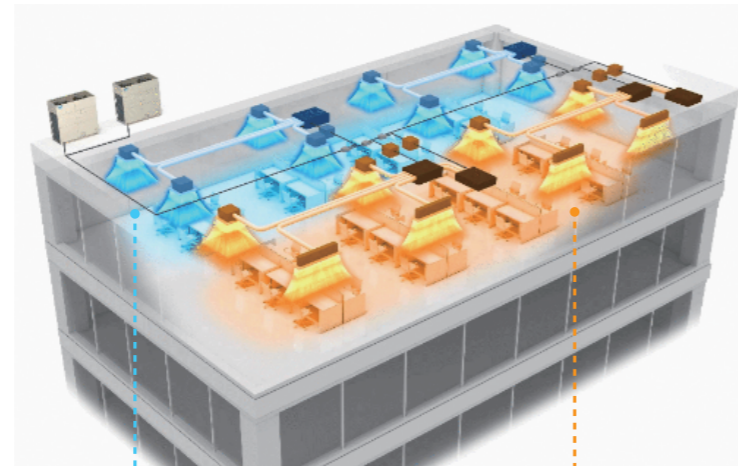

Cooling

Hot area due to heat released by computers, etc.  
→Cooling ON



Heating

Cold area during winter due to cold air coming from windows  
→Heating ON

## The heat recovery system improves energy efficiency by recycling waste heat.

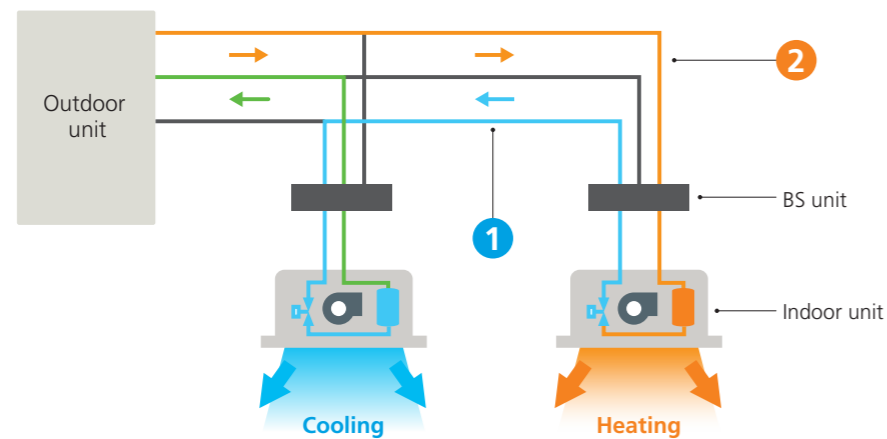

1 The (cold) waste heat from heating is used for the cooling operation.

2 The waste heat from cooling is used to generate heat that is needed for heating operation while conserving electricity.

## BS unit (Single type/Multi type)

See page 159 - 162

By adding suction gas piping and a BS unit (sold separately), simultaneous cooling and heating operation can be provided by a single system.



Single BS unit



Multi BS unit

### Heat pump

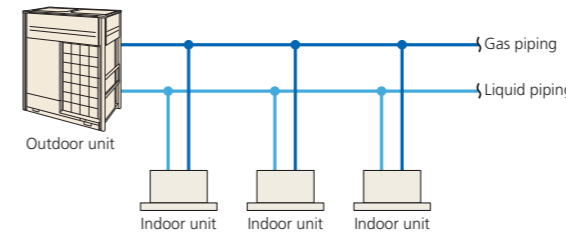

### Heat recovery

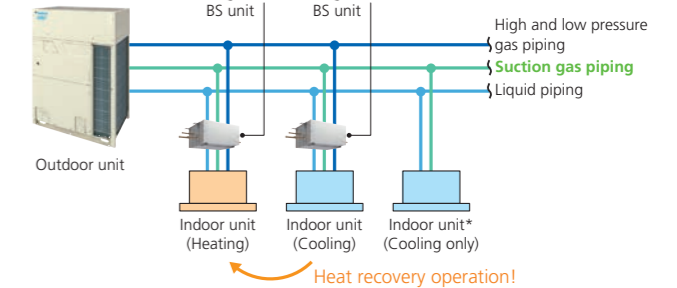

\* For indoor units used for cooling only (do not connect to BS unit when using for heat recovery), total capacity index must be 50% or less than the capacity index of the outdoor units.

## Application reference

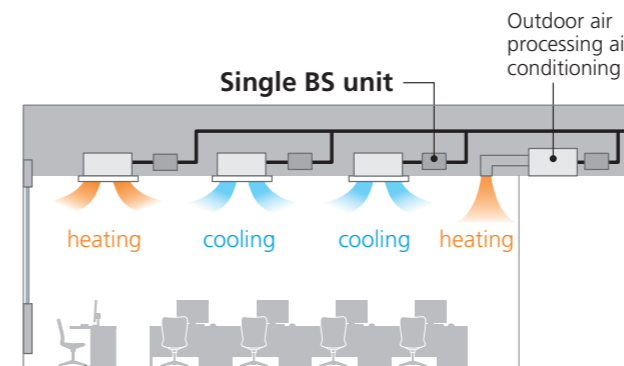

### Winter season (Office Building)

- Difference between the load of cold air and heat from room is large
- Can be used with the outdoor air processing air conditioning

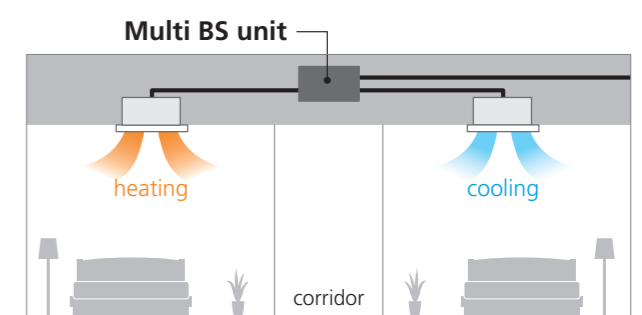

### Winter season (Hotel)

- Able to cater to individual heating and cooling requirement



# New Casing

Offers advanced design and new structure with excellent workability. The larger single module casing reduces installation cost and space also.



## Outdoor unit combinations

System capacity		Number of units	Single module (class)										
Class	kW		8	10	12	14	16	18	20	22	24		
8	22.4	Single	●										
10	28.0			●									
12	33.5				●								
14	40.0					●							
16	45.0						●						
18	50.0							●					
20	56.0								●				
22	61.5									●			
24	67.0									●			
26	73.5	Double			●	●							
28	78.5				●		●						
30	83.5				●			●					
32	89.5				●				●				
34	96.0					●				●			
36	101						●				●		
38	106							●				●	
40	112								●				
42	117	Triple						●			●		
44	123									●		●	
46	129										●		
48	134											●	
50	140				●						●	●	
52	146				●						●	●	
54	152					●					●	●	
56	157						●				●	●	
58	162						●			●	●		
60	168							●		●	●		

## Large-capacity single module

Single module reduces installation space

Conventional models  
**VRV R SERIES**

22, 24 class

1,880 mm  
(930 mm + 20 mm + 930 mm) 765 mm

Installation space **1.44 m<sup>2</sup>**

Machine weight **460 kg**

New models  
**VRV R SERIES**

22, 24 class

1,750 mm 765 mm

Installation space **1.34 m<sup>2</sup>**

Machine weight **409 kg**

Installation space  
**7% less**

Machine weight  
**11% less**

## New reinforced design

The frame structure has been strengthened to improve resistance to earthquakes and wind while protecting against falling damage.



- 1 Minimises horizontal wobbling**

Conventional models **VRV R SERIES**
- 2 Minimises vibration from various angles**

Conventional models **VRV R SERIES**



# Energy Savings

## High TCSPF / HSPF

Energy savings during actual operation have been further improved by the evolution of software and hardware technologies. Achieved high values for TCSPF and HSPF in all series.

TCSPF (for commercial use)

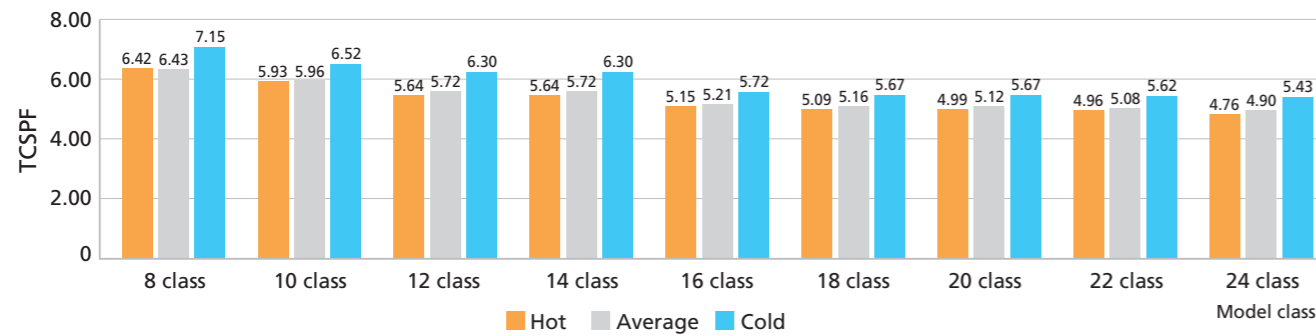

HSPF (for commercial use)

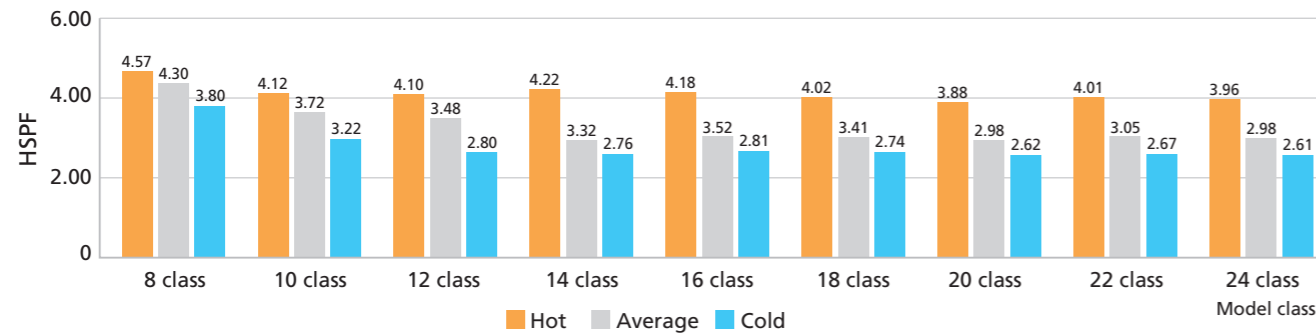

## What are TCSPF and HSPF ?

TCSPF: Total Cooling Seasonal Performance Factor  
 HSPF: Heating Seasonal Performance Factor

In simple terms, TCSPF & HSPF represents the ratio of the Total Cooling & Heating capacity of the air-conditioner relative to the Total energy consumed by the air-conditioner during the Total Cooling & Heating operation periods in a year.

Whereas the previous index of AEER & ACOP was calculated using only one representative outdoor temperature (35°C for cooling and 7°C for heating), the new index of TCSPF & HSPF uses a broader range of annual outdoor temperatures\* as stipulated in AS/NZS 3823.4.1:2014.

Further, the annual outdoor temperatures are based on zoning Australia/New Zealand into three distinct climate zones (Hot/Average/Cold).

This allows you to determine the performance efficiency of different air-conditioners by comparing their TCSPF & HSPF within the same climate zone.

\* There are two kinds of annual outdoor temperatures and it's different for residential and commercial use.

## Hardware technology High Efficiency Compressor

New technologies increase seasonal efficiency and enable a compact design.

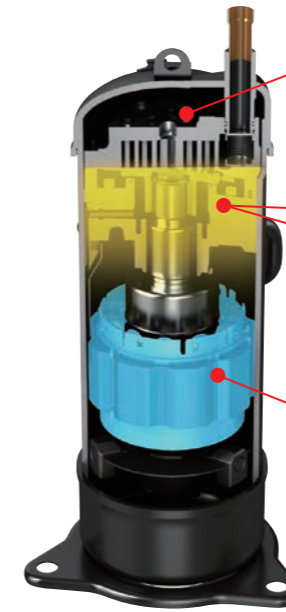

### Improvement of the discharge port

By improving the shape of the refrigerant discharge port, the pressure increase near the discharge port of the gas refrigerant after compression is suppressed and the compression loss is reduced.

### Optimising the back pressure control

### New oil control function

In addition to the conventional intermediate pressure adjustment port, the pressing pressure of the orbiting scroll during operation has been optimised, and the newly adopted oil control mechanism has reduced gas leakage and mechanical loss.

### Adoption of a high-performance concentrated motor

By adopting it, the coil circumference is greatly reduced, which makes the coil denser and thicker, and the electrical resistance of the coil is dramatically reduced to improve motor efficiency. Furthermore, the motor is light-weighted and downsized.

## Software technology VRT Smart control

Fully Automatic Energy-saving Refrigerant Control

### Optimal supply exactly meets the required capacity of indoor units

- Reduces compressor load and minimises operation loss so it is energy saving.
- Controls capacity according to load to ensure a constant room temperature for greater comfort.

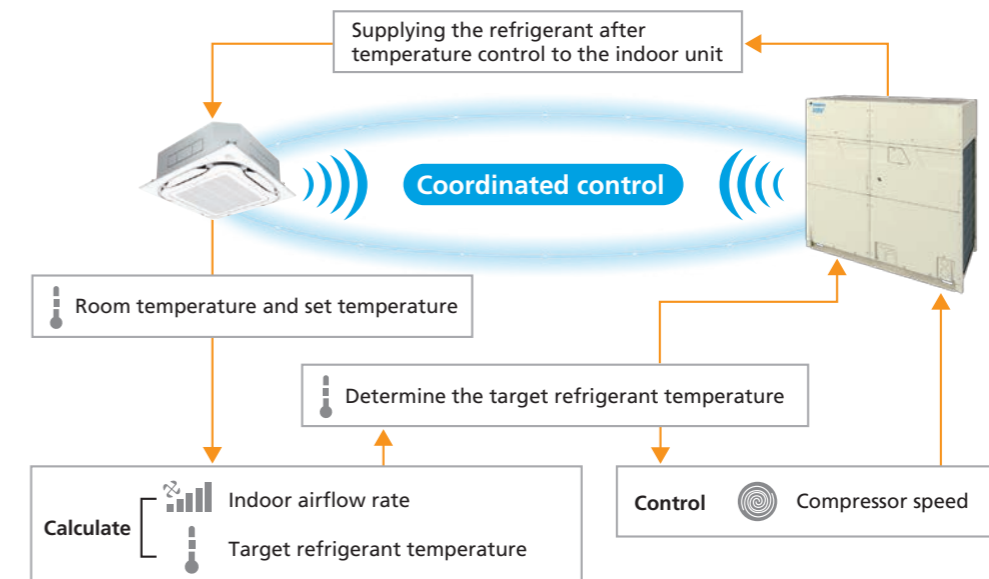

\* For the classification of indoor units (VRT smart control and VRT control), refer to the indoor unit lineup.



# Design Flexibility

## Simultaneous extension of height difference and equivalent length

Design flexibility is further improved by simultaneous extension of height difference, improved from 90 m to 110 m, and equivalent length (up to 190 m).

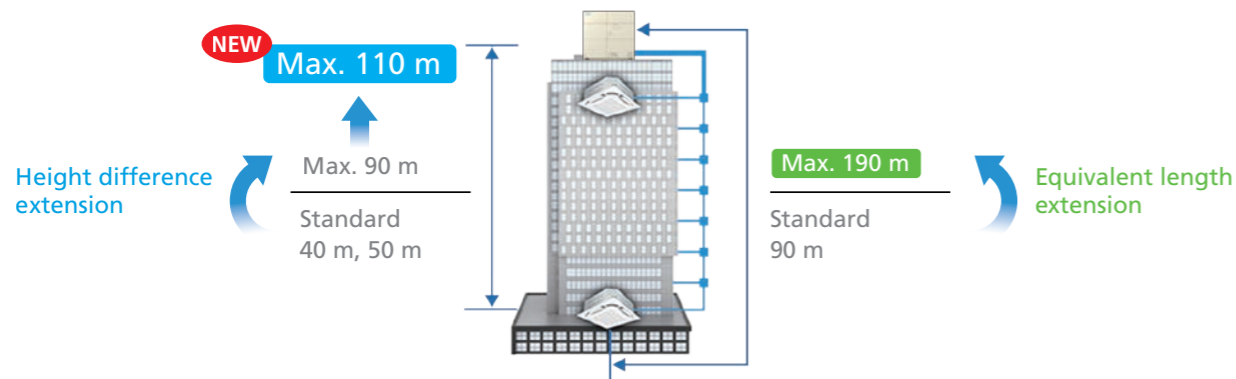

### Height difference extension **Max. 110 m**

For height differences exceeding 50 m with the outdoor unit above the indoor unit and 40 m with the outdoor unit below, the main piping liquid piping size must be increased.

### Equivalent length extension **Max. 190 m**

When the equivalent piping length from outdoor unit to indoor unit is 90 m or more, be sure to increase the main piping liquid piping size.

\* In addition to increasing the size of the main pipe, there are other piping restrictions regarding height difference extension and equivalent length extension. Check the Installation Manual for details.

## REFNET header downstream branching supported

Piping branch by REFNET joint is possible downstream of REFNET header. The indoor unit arrangement can be more flexible.

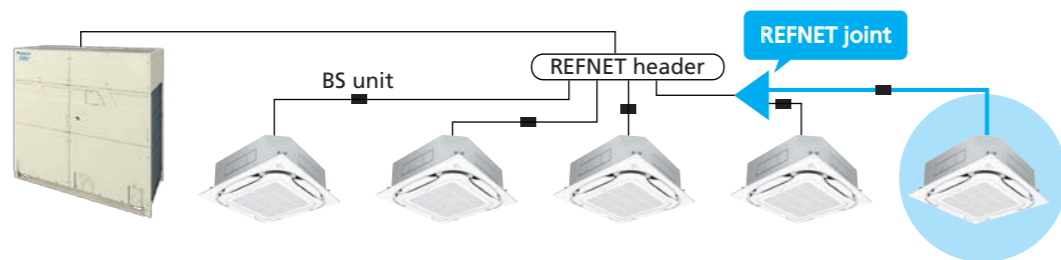

REFNET header		Indoor unit total capacity at REFNET joint
3 pipes	2 pipes	
KHRP25M33H, KHRP25M72H + KHRP25M72TP	KHRP26M22H, KHRP26M33H, KHRP26M72H	< 50
KHRP25M73H + KHRP25M73TP	KHRP26M73H + KHRP26M73HP	≤ 140

## Long piping length

Long piping length enhances design flexibility, enabling support for large buildings.

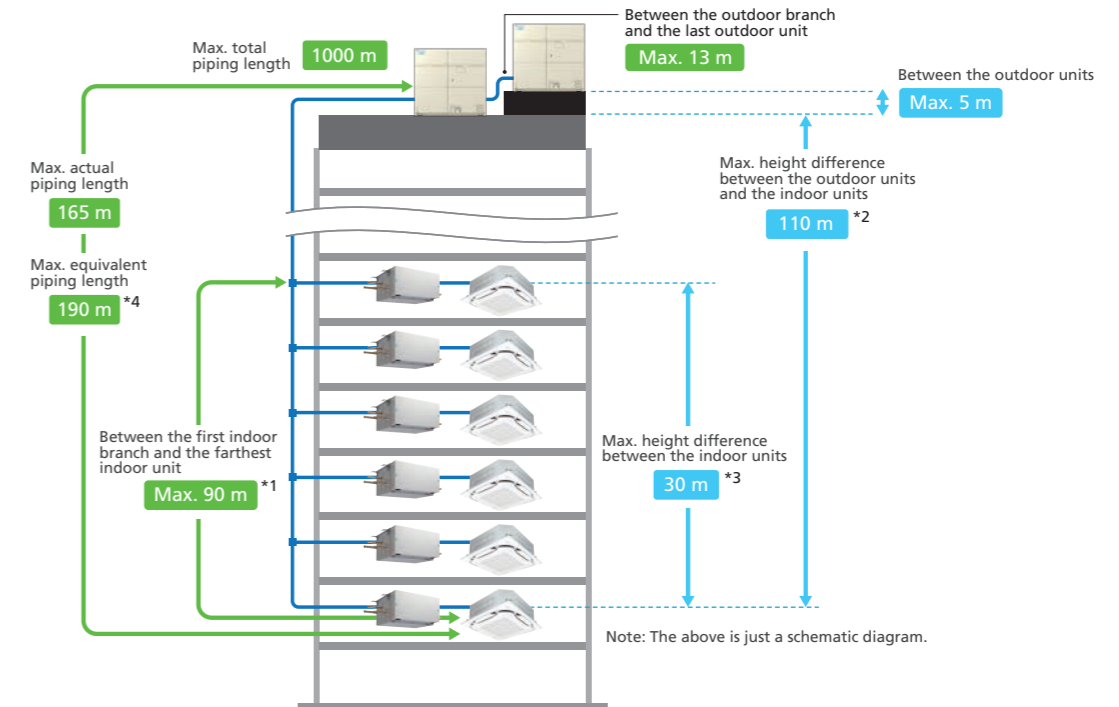

Maximum allowable piping length	Actual piping length (Equivalent)	165 m (190 m) <sup>*4</sup>
	Total piping length	1000 m
	Between the first indoor branch and the farthest indoor unit	90 m <sup>*1</sup>
Maximum allowable height difference	Between the outdoor branch and the last outdoor unit (Equivalent)	10 m (13 m)
	Between the outdoor units (Multiple use)	5 m
	Between the indoor units	30 m
	Between the outdoor units and the indoor units	110 m <sup>*2</sup>

\*1. No special requirements up to 40 m. The maximum actual piping length can be 90 m, depending on conditions. Various conditions and requirements have to be met to allow utilisation of 90 m piping length. Be sure to refer to the Engineering Data Book for details of these conditions and requirements.  
 \*2. When Height differences above 50 m if the outdoor unit is above the indoor unit and 40 m if the outdoor unit is below the indoor unit, a dedicated setting on the outdoor unit is required. Refer to the Engineering Data Book and contact your local dealer for more information.  
 \*3. When Height differences are 15 m or more, maximum actual piping length must be 120 m.  
 \*4. In the case where the equivalent piping length from outdoor unit to indoor unit ≥ 90 m, make sure to up size the liquid pipe of the main pipe. Do not up size the high/low pressure gas pipe and the suction gas pipe.

## Connection ratio

Connection capacity at maximum is 200%.

Connection ratio **50%–200%**

$$\text{Connection ratio} = \frac{\text{Total capacity index of the indoor units}}{\text{Capacity index of the outdoor units}}$$

Conditions of VRV indoor unit connection capacity

Applicable VRV indoor units	Indoor units				Other VRV indoor unit models <sup>*1</sup>
	FXDQ	FXSQ	FXMQ-PA	FXAQ	
Single outdoor units	<b>200%</b>				200%
Double outdoor units					160%
Triple outdoor units					130%

\*1 For the FXF(S)(T)Q25 models, maximum connection ratio is 130 % for the entire range of outdoor units.  
 Note: If the operational capacity of indoor units is more than 130%, low airflow operation is enforced in all the indoor units.  
 \*Refer to page 33 for outdoor unit combination details.



# Easy Installation

## ■ Drainless Multi BS unit

Drainless function enables a drastic reduction of on-site work since no drain piping is required.

- Abundant lineup includes port counts of 4, 6, 8, 10, 12, and 16. \*
- Drain is eliminated with the use of foam insulation inside the casing. On-site work has significantly been reduced for lower installation costs.

\*Drainless function is available up to 12-port unit. The 16-port unit requires drain piping.

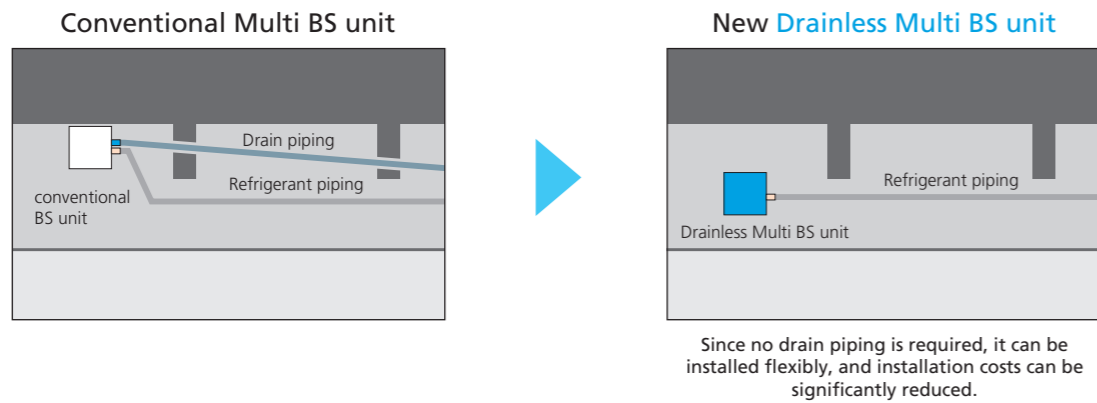
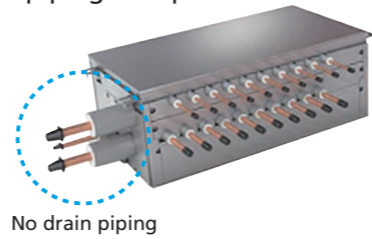

## ■ Electrical component service window

An electrical component service window is newly installed on the front panel. Main PCB 7-segment LED can be accessed without removing the front panel.

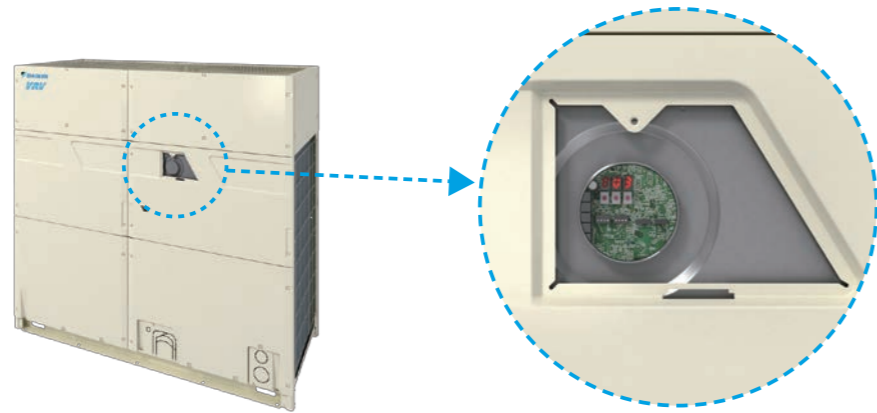

Workability is greatly improved during on-site setting or test run. You can also quickly check the error code during service.

## ■ Improved refrigerant piping workability

By dividing piping and wiring holes to the left and right, piping and wiring work can be easily performed on site.

Conventional models



Working in close placed is difficult

VRV R SERIES

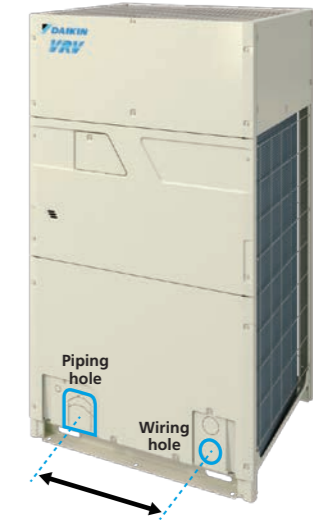

Work becomes easier with sufficient space



## ■ IP55-compliant sealed component box

IP55 sealed component box protects electrical component from a cause of failure, that is the ingress of debris (lizards, bugs, sand, water, snow).

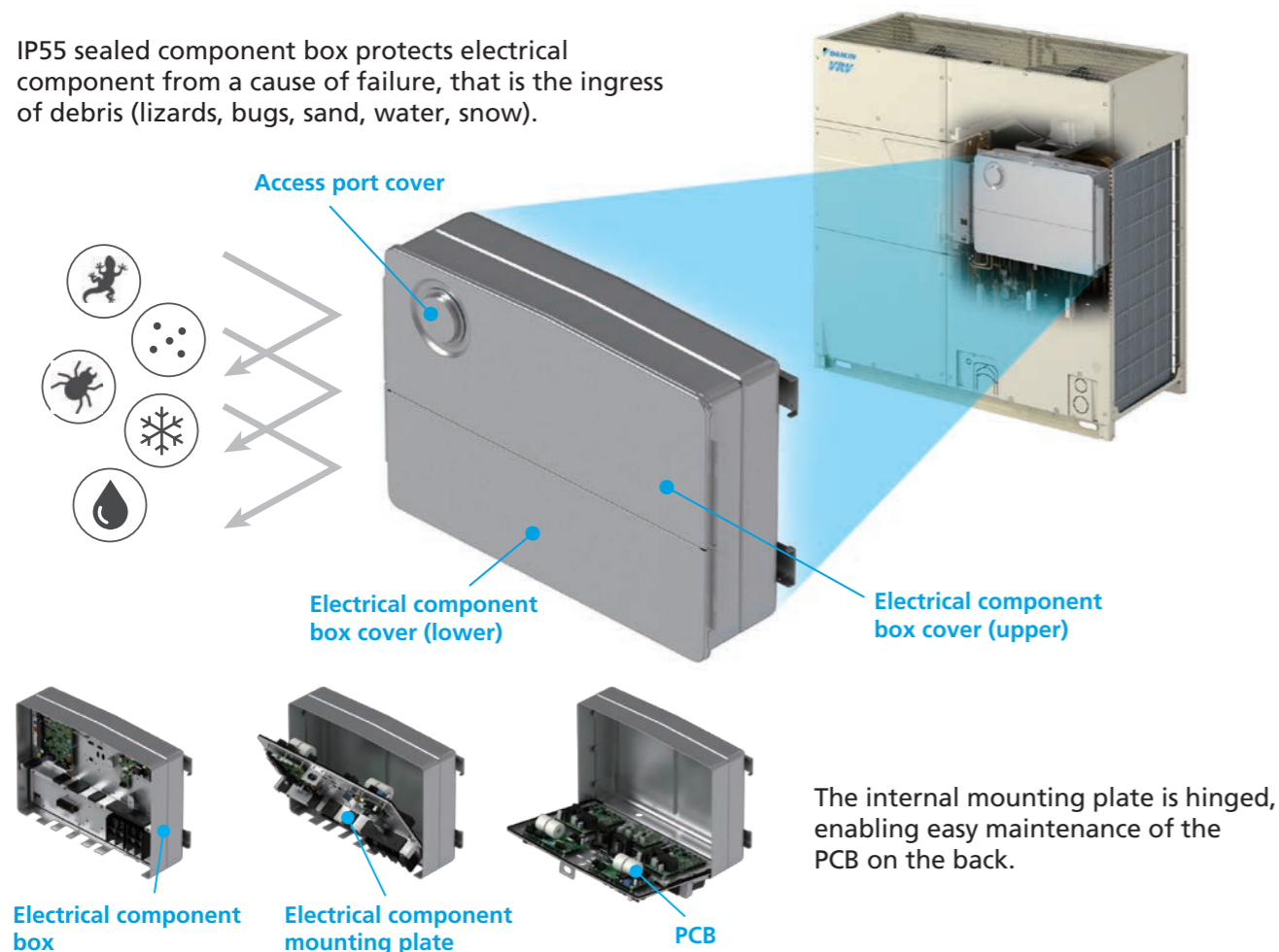

## ■ Enables operation in high outdoor temperature

Three refrigerant cooling circuits enable stable operation even in high outdoor temperatures by suppressing a temperature rise for the PCB mounted in the sealed electrical component box.

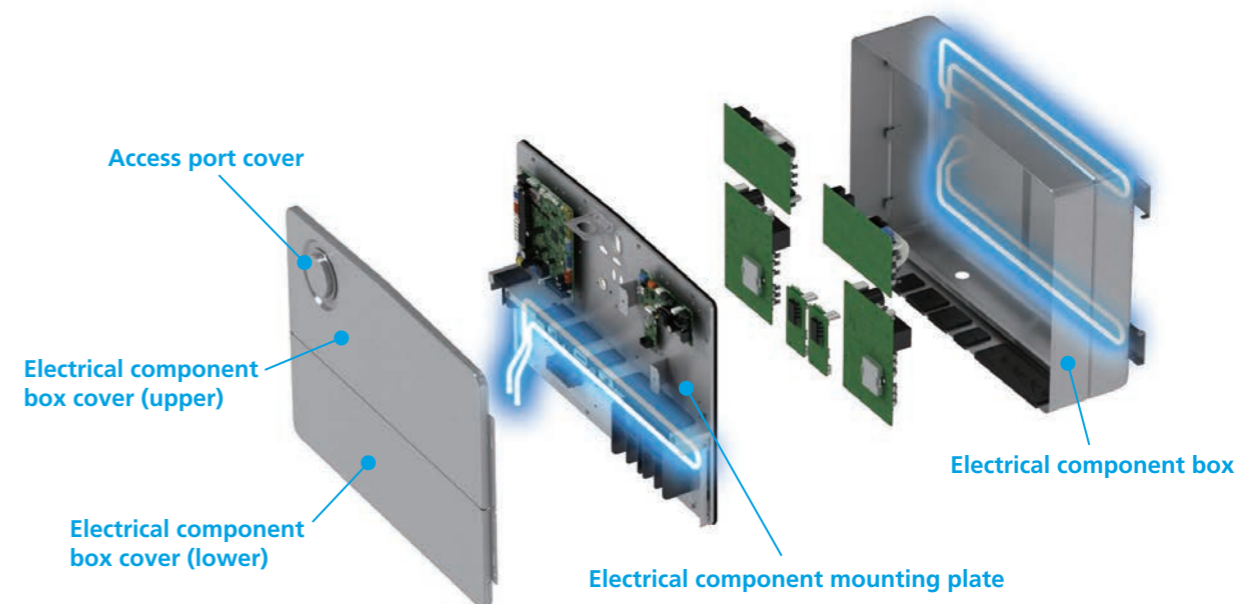

## What is IP55?

IP55 is the degrees of dust and water protection for the electrical component box equipped on the product.

# IP55

### Liquid ingress protection **Grade 5**

Water projected by a nozzle (6.3 mm) against enclosure from any direction shall have no harmful effects.

### Solid particle protection **Grade 5**

Ingress of dust is not entirely prevented, but it must not enter in sufficient quantity to interfere with the satisfactory operation of the equipment.

Ingress Protection

\*IP55 is the protection degree of the wiring box as a single unit. The protection grade of outdoor unit is IP14 as well as conventional model.



## Outdoor unit multi-defrost function

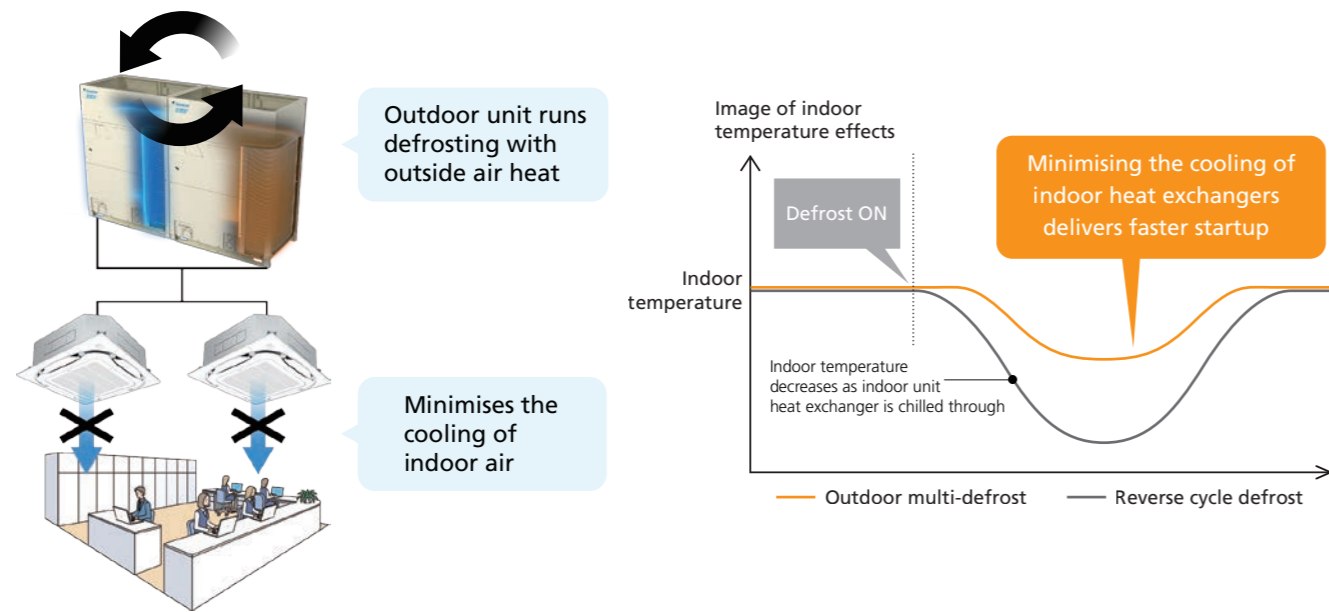

### Improves comfort of defrosting operation

Defrosting in conventional models temporarily reverses the refrigerant cycle to use indoor heat to melt the frost, thus causing the indoor temperature to fall (reverse cycle defrost).

The "outdoor multi-defrost function" enables large-capacity casing models of 22 and 24 class and multi outdoor units to use outdoor heat for heat exchange and interchange defrost operation while minimising indoor heat absorption and decreases in indoor temperature.

\*Reverse cycle defrost may also take place to protect the product.

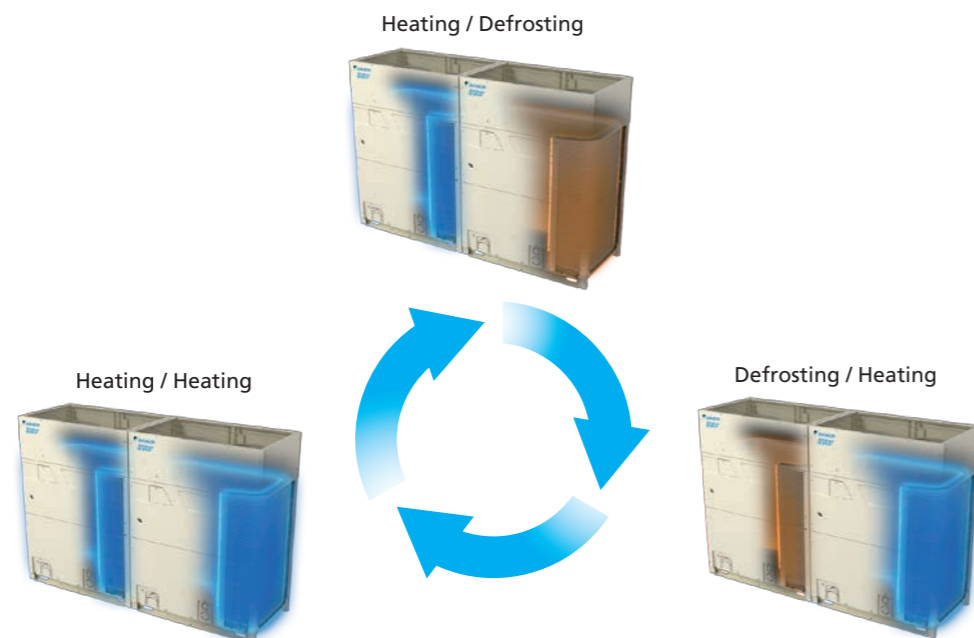

## Double backup operation functions

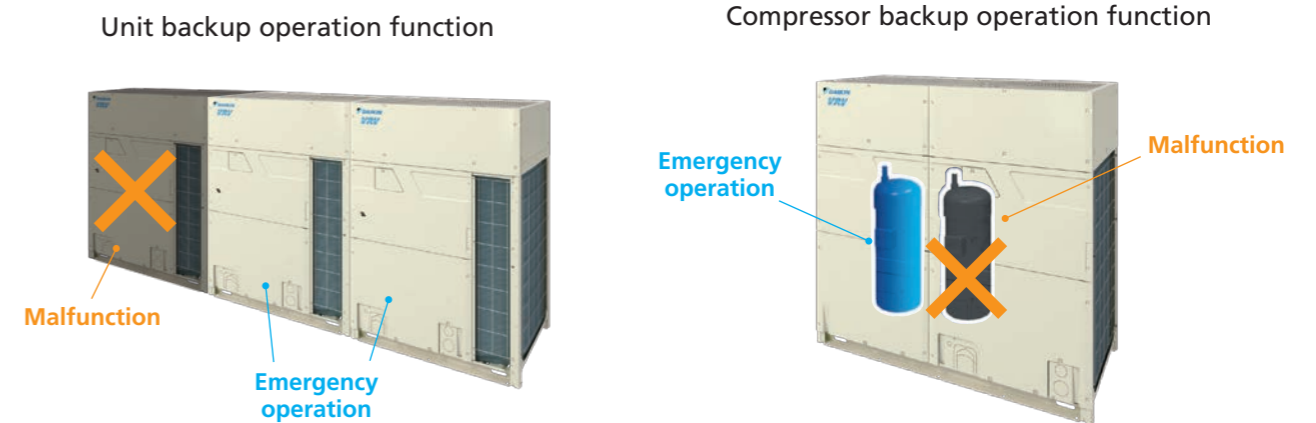

## Nighttime quiet operation function

The nighttime quiet operation function automatically suppresses the nighttime operating sound by reducing operation capacity to maintain the quiet environment of the neighborhood. Three selectable modes are available depending on the required level.

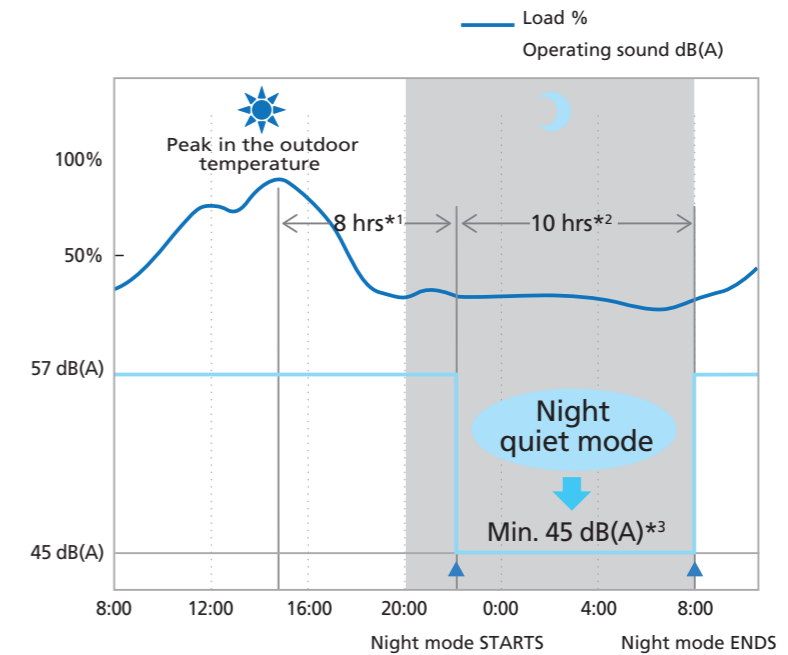

\*1. Initial setting is 8 hours. Can be selected from 6, 8 and 10 hours.  
 \*2. Initial setting is 9 hours. Can be selected from 8, 9 and 10 hours.  
 \*3. In case of 10 class outdoor unit.

Notes: • This function is available in setting at site.  
 • The operating sound in quiet operation mode is the actual value measured by our company.  
 • The relationship of outdoor temperature (load) and time shown above is just an example.



# Outdoor Unit Lineup

## VRV R Series

### Capacity range from 8 to 60 class

#### Lineup

class	8	10	12	14	16	18	20	22	24	26	28	30	32	34	36	38	40	42	44	46	48	50	52	54	56	58	60
Single outdoor units	●	●	●	●	●	●	●	●	●																		
Double outdoor units										●	●	●	●	●	●	●	●	●	●	●	●	●					
Triple outdoor units																						●	●	●	●	●	●

### Outdoor unit combinations

class	kW	Capacity index	Model name	Combination	Outdoor unit multi connection piping kit*1	Total capacity index of connectable indoor units*2	Maximum number of connectable indoor units*2
8	22.4	200	REYQ8B	REYQ8B	-	100 to 260 (400)	13 (20)
10	28.0	250	REYQ10B	REYQ10B	-	125 to 325 (500)	16 (25)
12	33.5	300	REYQ12B	REYQ12B	-	150 to 390 (600)	19 (30)
14	40.0	350	REYQ14B	REYQ14B	-	175 to 455 (700)	22 (35)
16	45.0	400	REYQ16B	REYQ16B	-	200 to 520 (800)	26 (40)
18	50.0	450	REYQ18B	REYQ18B	-	225 to 585 (900)	29 (45)
20	56.0	500	REYQ20B	REYQ20B	-	250 to 650 (1,000)	32 (50)
22	61.5	550	REYQ22B	REYQ22B	-	275 to 715 (990)	35 (49)
24	67.0	600	REYQ24B	REYQ24B	-	300 to 780 (1,080)	39 (54)
26	73.5	650	REYQ26B	REYQ12B + REYQ14B	BHFP26R135	325 to 845 (1,040)	42 (52)
28	78.5	700	REYQ28B	REYQ12B + REYQ16B		350 to 910 (1,120)	45 (56)
30	83.5	750	REYQ30B	REYQ12B + REYQ18B		375 to 975 (1,200)	48 (60)
32	89.5	800	REYQ32B	REYQ12B + REYQ20B		400 to 1,040 (1,280)	52 (64)
34	96.0	850	REYQ34B	REYQ14B + REYQ20B		425 to 1,105 (1,360)	55 (64)
36	101	900	REYQ36B	REYQ16B + REYQ20B		450 to 1,170 (1,440)	58 (64)
38	106	950	REYQ38B	REYQ18B + REYQ20B		475 to 1,235 (1,520)	61 (64)
40	112	1,000	REYQ40B	REYQ20B × 2		500 to 1,300 (1,600)	64 (64)
42	117	1,050	REYQ42B	REYQ18B + REYQ24B		525 to 1,365 (1,680)	
44	123	1,100	REYQ44B	REYQ20B + REYQ24B		550 to 1,430 (1,760)	
46	129	1,150	REYQ46B	REYQ22B + REYQ24B	575 to 1,495 (1,840)		
48	134	1,200	REYQ48B	REYQ24B × 2	600 to 1,560 (1,920)		
50	140	1,250	REYQ50B	REYQ12B + REYQ18B + REYQ20B	625 to 1,625 (1,625)		
52	146	1,300	REYQ52B	REYQ12B + REYQ20B × 2	650 to 1,690 (1,690)		
54	152	1,350	REYQ54B	REYQ14B + REYQ20B × 2	675 to 1,755 (1,755)		
56	157	1,400	REYQ56B	REYQ16B + REYQ20B × 2	700 to 1,820 (1,820)		
58	162	1,450	REYQ58B	REYQ18B + REYQ20B × 2	725 to 1,885 (1,885)		
60	168	1,500	REYQ60B	REYQ20B × 3	750 to 1,950 (1,950)		

Notes: \*1. For multiple connection of 26 class systems and above, the outdoor unit multi connection piping kit (separately sold) is required.  
 \*2. Values inside brackets are based on connection of indoor units rated at maximum capacity, 200% for REYQ8-20BYM9, 180% for REYQ22/24BYM9, 160% for double outdoor units, and 130% for triple outdoor units. Refer to page 26 for note on connection capacity of indoor units.

# Indoor Unit Lineup

### Enhanced range of choices

Category	Type	Model Name	Capacity Range(kW)	Capacity Index																											
				20	25	32	40	50	63	71	80	100	125	140	145	160	180	200	250												
Ceiling Mounted Cassette	Round Flow Cassette with Sensing and Streamer	New FXFTQ-AVM	2.2-2.8	●	●	●	●	●	●	●	●	●	●	●	●	●	●	●	●	●	●	●	●	●	●	●	●	●			
	Round Flow Cassette with Sensing	FXFSQ-AVM	2.2-2.8	●	●	●	●	●	●	●	●	●	●	●	●	●	●	●	●	●	●	●	●	●	●	●	●	●	●		
	Round Flow Cassette	FXFQ-AVM	2.2-2.8	●	●	●	●	●	●	●	●	●	●	●	●	●	●	●	●	●	●	●	●	●	●	●	●	●	●		
	Compact Multi Flow Cassette	New FXZQ-BVM	2.2-2.8	●	●	●	●	●	●	●	●	●	●	●	●	●	●	●	●	●	●	●	●	●	●	●	●	●	●		
	Double Flow Cassette	New FXCQ-BVM	2.2-2.8	●	●	●	●	●	●	●	●	●	●	●	●	●	●	●	●	●	●	●	●	●	●	●	●	●	●		
Ceiling Concealed Duct	Slim Duct (Standard)	FXDQ-PDVE	2.2-2.8	●	●	●	●	●	●	●	●	●	●	●	●	●	●	●	●	●	●	●	●	●	●	●	●	●	●		
		FXDQ-NDVE	2.2-2.8	●	●	●	●	●	●	●	●	●	●	●	●	●	●	●	●	●	●	●	●	●	●	●	●	●	●		
	Slim Duct (Compact)	FXDQ-TV1C(A)	2.2-2.8	●	●	●	●	●	●	●	●	●	●	●	●	●	●	●	●	●	●	●	●	●	●	●	●	●	●		
	Middle Static Pressure Duct	FXSQ-PAVE	2.2-2.8	●	●	●	●	●	●	●	●	●	●	●	●	●	●	●	●	●	●	●	●	●	●	●	●	●	●		
		FXDYQ-MAV1	2.2-2.8	●	●	●	●	●	●	●	●	●	●	●	●	●	●	●	●	●	●	●	●	●	●	●	●	●	●		
	Middle-High Static Pressure Duct	FXMQ-PAVE	2.2-2.8	●	●	●	●	●	●	●	●	●	●	●	●	●	●	●	●	●	●	●	●	●	●	●	●	●	●		
		FXMQ-PV1A	2.2-2.8	●	●	●	●	●	●	●	●	●	●	●	●	●	●	●	●	●	●	●	●	●	●	●	●	●	●		
	High Static Pressure Duct	FXMQ-MFV1	2.2-2.8	●	●	●	●	●	●	●	●	●	●	●	●	●	●	●	●	●	●	●	●	●	●	●	●	●	●		
		New FXMQ-AFVM	2.2-2.8	●	●	●	●	●	●	●	●	●	●	●	●	●	●	●	●	●	●	●	●	●	●	●	●	●	●		
	Ceiling Suspended	4-Way Flow Ceiling Suspended	FXUQ-AVEB	2.2-2.8	●	●	●	●	●	●	●	●	●	●	●	●	●	●	●	●	●	●	●	●	●	●	●	●	●		
Ceiling Suspended		New FXHQ-BVM	2.2-2.8	●	●	●	●	●	●	●	●	●	●	●	●	●	●	●	●	●	●	●	●	●	●	●	●	●			
Wall Mounted	Floor Standing	FXAQ-AVM	2.2-2.8	●	●	●	●	●	●	●	●	●	●	●	●	●	●	●	●	●	●	●	●	●	●	●	●	●			
	Concealed Floor Standing	FXLQ-MAVE	2.2-2.8	●	●	●	●	●	●	●	●	●	●	●	●	●	●	●	●	●	●	●	●	●	●	●	●	●			
Heat Reclaim Ventilator	VAM-HVE																														

Note: For indoor units without 'VRT Smart', the standard 'VRT' control is available (excludes Heat Reclaim Ventilators).



- Max. 64 indoor units
- If a system has indoor units subject to both VRT smart and VRT control, the system is operated under VRT control.
- If a system has both outdoor-air processing air conditioners (FXMQ-MF series) and outdoor-air processing type indoor units, VRT smart control and VRT control are disabled.



# Outdoor Units

## VRV R Series

### Specifications

Heat Recovery

Model		REYQ8BYM9	REYQ10BYM9	REYQ12BYM9	REYQ14BYM9	REYQ16BYM9	REYQ18BYM9	REYQ20BYM9	REYQ22BYM9	REYQ24BYM9	REYQ26BYM9	REYQ28BYM9	REYQ30BYM9	REYQ32BYM9	REYQ34BYM9	REYQ12BYM9	REYQ14BYM9	REYQ16BYM9	REYQ18BYM9	REYQ20BYM9	REYQ22BYM9	REYQ24BYM9	REYQ26BYM9	REYQ28BYM9	REYQ30BYM9	REYQ32BYM9	REYQ34BYM9	REYQ12BYM9	REYQ14BYM9	
Combination units		—																												
Power supply		3-phase 4-wire system, 380-415 V/380 V, 50/60 Hz														3-phase 4-wire system, 380-415 V/380 V, 50/60 Hz														
Cooling capacity	Btu/h	76,400	95,500	114,000	136,000	154,000	171,000	191,000	210,000	229,000	251,000	268,000	285,000	305,000	328,000	210,000	229,000	251,000	268,000	285,000	305,000	328,000	251,000	268,000	285,000	305,000	328,000	210,000	229,000	
	kW	22.4	28.0	33.5	40.0	45.0	50.0	56.0	61.5	67.0	73.5	78.5	83.5	89.5	96.0	61.5	67.0	73.5	78.5	83.5	89.5	96.0	73.5	78.5	83.5	89.5	96.0	61.5	67.0	
Heating capacity	Btu/h	85,300	107,000	128,000	154,000	171,000	191,000	215,000	235,000	256,000	282,000	299,000	319,000	345,000	369,000	235,000	256,000	282,000	299,000	319,000	345,000	369,000	282,000	299,000	319,000	345,000	369,000	235,000	256,000	
	kW	25.0	31.5	37.5	45.0	50.0	56.0	63.0	69.0	75.0	82.5	87.5	93.5	101	108	69.0	75.0	82.5	87.5	93.5	101	108	82.5	87.5	93.5	101	108	69.0	75.0	
Power consumption	Cooling	5.17	6.80	8.71	11.2	12.9	14.4	17.5	18.6	21.3	19.9	21.6	23.1	26.2	28.7	18.6	21.3	19.9	21.6	23.1	26.2	28.7	19.9	21.6	23.1	26.2	28.7	18.6	21.3	
	Heating	5.68	7.29	9.81	12.8	13.6	14.5	17.2	19.6	22.2	22.6	23.4	24.3	27.3	30.0	19.6	22.2	22.6	23.4	24.3	27.3	30.0	22.6	23.4	24.3	27.3	30.0	19.6	22.2	
Capacity control	%	11-100	7-100		6-100	5-100		4-100	3-100		3-100		2-100		3-100		3-100		2-100		3-100		3-100		2-100		3-100			
AEER*	Cooling	4.00	3.83	3.61	3.34	3.28	3.27	3.03	3.12	2.98	3.45	3.40	3.39	3.22	3.15	3.12	2.98	3.45	3.40	3.39	3.22	3.15	3.45	3.40	3.39	3.22	3.15	3.12	2.98	
ACOP*	Heating	4.09	4.04	3.61	3.32	3.46	3.63	3.47	3.33	3.21	3.44	3.54	3.65	3.52	3.42	3.33	3.21	3.44	3.54	3.65	3.52	3.42	3.44	3.54	3.65	3.52	3.42	3.33	3.21	
TCSPF* (Cooling)	Hot	6.42 / 5.57	5.93 / 5.27	5.64 / 5.02	5.64 / 4.96	5.15 / 4.58	5.09 / 4.53	4.99 / 4.43	4.96 / 4.43	4.76 / 4.25	5.64 / 4.99	5.35 / 4.76	5.30 / 4.72	5.22 / 4.64	5.25 / 4.64	4.96 / 4.43	4.76 / 4.25	5.64 / 4.99	5.35 / 4.76	5.30 / 4.72	5.22 / 4.64	5.25 / 4.64	5.64 / 4.99	5.35 / 4.76	5.30 / 4.72	5.22 / 4.64	5.25 / 4.64	4.96 / 4.43	4.76 / 4.25	
	Average	6.43 / 4.55	5.96 / 4.44	5.72 / 4.31	5.72 / 4.14	5.21 / 3.90	5.16 / 3.89	5.12 / 3.84	5.08 / 3.86	4.90 / 3.74	5.73 / 4.22	5.42 / 4.07	5.38 / 4.05	5.34 / 4.01	5.36 / 3.96	5.08 / 3.86	4.90 / 3.74	5.73 / 4.22	5.42 / 4.07	5.38 / 4.05	5.34 / 4.01	5.36 / 3.96	5.73 / 4.22	5.42 / 4.07	5.38 / 4.05	5.34 / 4.01	5.36 / 3.96	5.08 / 3.86	4.90 / 3.74	
HSPF* (Heating)	Hot	4.57 / 4.58	4.12 / 4.13	4.10 / 4.11	4.22 / 4.15	4.18 / 4.18	4.02 / 4.03	3.88 / 3.89	4.01 / 3.93	3.96 / 3.88	4.17 / 4.17	4.16 / 4.16	4.06 / 4.07	3.97 / 3.98	4.02 / 3.96	4.01 / 3.93	3.96 / 3.88	4.17 / 4.17	4.16 / 4.16	4.06 / 4.07	3.97 / 3.98	4.02 / 3.96	4.17 / 4.17	4.16 / 4.16	4.06 / 4.07	3.97 / 3.98	4.02 / 3.96	4.01 / 3.93	3.96 / 3.88	
	Average	4.30 / 4.15	3.72 / 3.59	3.48 / 3.00	3.32 / 2.80	3.52 / 3.01	3.41 / 2.93	2.98 / 2.80	3.05 / 2.51	2.98 / 2.44	3.26 / 3.06	3.51 / 3.01	3.44 / 2.97	3.35 / 2.87	3.12 / 2.61	3.05 / 2.51	2.98 / 2.44	3.26 / 3.06	3.51 / 3.01	3.44 / 2.97	3.35 / 2.87	3.12 / 2.61	3.26 / 3.06	3.51 / 3.01	3.44 / 2.97	3.35 / 2.87	3.12 / 2.61	3.05 / 2.51	2.98 / 2.44	
Casing colour		Ivory white (5Y7.5/1)														Ivory white (5Y7.5/1)														
Compressor	Type	Hermetically sealed scroll type																												
	Motor output	kW	4.13	5.87	7.67	8.45	4.44+5.03	4.04+6.56	4.51+7.37	7.06+7.37	7.80+8.11	7.67+8.45	7.67+(4.44+5.03)	7.67+(4.04+6.56)	7.67+(4.51+7.37)	8.45+(4.51+7.37)	7.06+7.37	7.80+8.11	7.67+8.45	7.67+(4.44+5.03)	7.67+(4.04+6.56)	7.67+(4.51+7.37)	8.45+(4.51+7.37)	7.67+8.45	7.67+(4.44+5.03)	7.67+(4.04+6.56)	7.67+(4.51+7.37)	8.45+(4.51+7.37)	7.06+7.37	7.80+8.11
Airflow rate	ℓ/s	2,583	2,812	3,015	4,327	4,428	4,293	5,095	7,170		3,015+4,327		3,015+4,293		3,015+5,095		4,327+5,095		3,015+5,095		4,327+5,095		3,015+4,327		3,015+4,293		3,015+5,095			
	m³/min	155	169	181	260	266	258	306	430		181+260		181+266		181+258		181+306		260+306		260+306		181+260		181+266		181+258			
Dimensions (HxWxD)	mm	1,660x930x765				1,660x1,240x765				1,660x1,750x765				(1,660x930x765) + (1,660x1,240x765)				(1,660x1,240x765) + (1,660x1,240x765)												
Machine weight	kg	227	231	232	281	323	357		409	68	232+281	232+323	232+357	232+357	281+357	409	68	232+281	232+323	232+357	232+357	281+357	232+281	232+323	232+357	232+357	281+357	409	68	
Sound level	dB(A)	56	57	59	63	62	61	65	67	68	232+281	64	63	66	67	67	68	232+281	64	63	66	67	232+281	64	63	66	67	67	68	
Sound power	dB(A)	80		83		85		89		90		86		87		90		86		87		90		86		87		90		
Operation range	Cooling	-5 to 49																												
	Heating	-25 to 15.5																												
Refrigerant	Type	R-410A																												
	Charge	kg	10.6		10.9	11.7		11.7		11.7		10.9+11.7		11.7+11.7		10.6		10.9	11.7		11.7		10.9+11.7		11.7+11.7		10.6		10.9	
Piping connections	Liquid	mm	φ 9.5 (Brazeing)		φ 12.7 (Brazeing)		φ 15.9 (Brazeing)		φ 15.9 (Brazeing)		φ 15.9 (Brazeing)		φ 19.1 (Brazeing)		φ 19.1 (Brazeing)		φ 15.9 (Brazeing)		φ 15.9 (Brazeing)		φ 19.1 (Brazeing)		φ 19.1 (Brazeing)		φ 19.1 (Brazeing)		φ 19.1 (Brazeing)			
	Gas	mm	φ 19.1 (Brazeing)		φ 22.2 (Brazeing)		φ 28.6 (Brazeing)		φ 28.6 (Brazeing)		φ 28.6 (Brazeing)		φ 34.9 (Brazeing)		φ 28.6 (Brazeing)		φ 19.1 (Brazeing)		φ 19.1 (Brazeing)		φ 19.1 (Brazeing)		φ 19.1 (Brazeing)		φ 19.1 (Brazeing)		φ 19.1 (Brazeing)		φ 19.1 (Brazeing)	
	High and low pressure gas	mm	φ 15.9 (Brazeing)		φ 19.1 (Brazeing)		φ 22.2 (Brazeing)		φ 28.6 (Brazeing)		φ 28.6 (Brazeing)		φ 28.6 (Brazeing)		φ 28.6 (Brazeing)		φ 28.6 (Brazeing)		φ 28.6 (Brazeing)		φ 28.6 (Brazeing)		φ 28.6 (Brazeing)		φ 28.6 (Brazeing)		φ 28.6 (Brazeing)		φ 28.6 (Brazeing)	

Notes: Specifications are based on the following conditions:  
 • Cooling: Indoor temp.: 27°CDB, 19°CWB, Outdoor temp.: 35°CDB, Equivalent piping length: 7.5 m, Height difference: 0 m.  
 • Heating: Indoor temp.: 20°CDB, Outdoor temp.: 7°CDB, 6°CWB, Equivalent piping length: 7.5 m, Height difference: 0 m.  
 • Sound level: Anechoic chamber conversion value, measured at a point 1 m in front of the unit at a height of 1.5 m.  
 During actual operation, these values are normally somewhat higher as a result of ambient conditions and oil recovery mode.  
 When there is concern for noise the surrounding area such as residences, we recommend investigating the installation location and taking soundproofing measures.  
 ★ Values based on GEMS determination 2019.

**TCSPF: Total Cooling Seasonal Performance Factor**  
**HSPF: Heating Seasonal Performance Factor**  
 In simple terms, TCSPF & HSPF represents the ratio of the Total Cooling & Heating capacity of the air-conditioner relative to the Total energy consumed by the air-conditioner during the Total Cooling & Heating operation periods in a year.  
 Whereas the previous index of AEER & ACOP was calculated using only one representative outdoor temperature (35°C for cooling and 7°C for heating), the new index of TCSPF & HSPF uses a broader range of annual outdoor temperatures\* as stipulated in AS/NZS 3823.4.1:2014.  
 Further, the annual outdoor temperatures are based on zoning Australia/New Zealand into three distinct climate zones (Hot/Average/Cold). This allows you to determine the performance efficiency of different air-conditioners by comparing their TCSPF & HSPF within the same climate zone.  
 \* There are two kinds of annual outdoor temperatures and it's different for residential and commercial use.













# Outdoor Units

## VRV R Series

### Specifications

Heat Recovery

														
Model		REYQ36BYM9	REYQ38BYM9	REYQ40BYM9	REYQ42BYM9	REYQ44BYM9	REYQ46BYM9	REYQ48BYM9	REYQ50BYM9	REYQ52BYM9	REYQ54BYM9	REYQ56BYM9	REYQ58BYM9	REYQ60BYM9
Combination units		REYQ16BYM9 REYQ20BYM9	REYQ18BYM9 REYQ20BYM9	REYQ20BYM9 REYQ20BYM9	REYQ18BYM9 REYQ24BYM9	REYQ20BYM9 REYQ24BYM9	REYQ22BYM9 REYQ24BYM9	REYQ24BYM9 REYQ24BYM9	REYQ12BYM9 REYQ18BYM9 REYQ20BYM9	REYQ12BYM9 REYQ20BYM9 REYQ20BYM9	REYQ14BYM9 REYQ20BYM9 REYQ20BYM9	REYQ16BYM9 REYQ20BYM9 REYQ20BYM9	REYQ18BYM9 REYQ20BYM9 REYQ20BYM9	REYQ20BYM9 REYQ20BYM9
Power supply		3-phase 4-wire system, 380-415 V/380 V, 50/60 Hz						3-phase 4-wire system, 380-415 V/380 V, 50/60 Hz						
Cooling capacity	Btu/h	345,000	362,000	382,000	399,000	420,000	440,000	457,000	478,000	498,000	519,000	536,000	553,000	573,000
	kW	101	106	112	117	123	129	134	140	146	152	157	162	168
Heating capacity	Btu/h	386,000	406,000	430,000	447,000	471,000	491,000	512,000	536,000	560,000	583,000	601,000	621,000	645,000
	kW	113	119	126	131	138	144	150	157	164	171	176	182	189
Power consumption	Cooling kW	30.4	31.9	35.0	35.7	38.8	40.2	42.6	40.9	44.0	46.2	47.9	49.4	52.5
	Heating kW	30.8	31.7	34.4	36.7	39.4	41.8	44.4	41.8	44.5	47.2	48.0	48.9	51.6
Capacity control		2-100						2-100						
AEER*	Cooling	3.13	3.13	3.03	3.10	3.00	3.04	2.98	3.22	3.13	3.10	3.09	3.09	3.03
ACOP*	Heating	3.50	3.58	3.50	3.42	3.36	3.31	3.25	3.58	3.51	3.45	3.50	3.55	3.50
TCSPF* (Cooling)	Hot	5.06 / 4.50	5.04 / 4.48	4.99 / 4.43	4.90 / 4.37	4.87 / 4.34	4.85 / 4.33	4.77 / 4.26	5.17 / 4.59	5.12 / 4.55	5.15 / 4.56	5.04 / 4.47	5.02 / 4.46	4.99 / 4.43
	Average	5.17 / 3.87	5.14 / 3.87	5.13 / 3.84	5.01 / 3.80	5.00 / 3.79	4.98 / 3.80	4.90 / 3.74	5.27 / 3.96	5.25 / 3.94	5.27 / 3.92	5.15 / 3.86	5.14 / 3.86	5.13 / 3.84
	Cold	5.70 / 3.90	5.68 / 3.90	5.68 / 3.90	5.53 / 3.84	5.54 / 3.85	5.52 / 3.85	5.43 / 3.80	5.82 / 3.99	5.82 / 3.99	5.84 / 3.97	5.70 / 3.90	5.68 / 3.90	5.68 / 3.90
HSPF* (Heating)	Hot	4.02 / 4.02	3.95 / 3.96	3.89 / 3.90	3.99 / 4.00	3.93 / 3.93	3.99 / 3.91	3.97 / 3.89	3.99 / 4.00	3.94 / 3.95	3.97 / 3.98	3.97 / 3.98	3.93 / 3.94	3.89 / 3.90
	Average	3.09 / 2.90	3.34 / 2.87	2.99 / 2.81	3.04 / 2.84	2.99 / 2.79	3.02 / 2.48	2.99 / 2.45	3.38 / 2.90	3.33 / 2.85	3.07 / 2.88	3.05 / 2.86	3.32 / 2.85	2.99 / 2.81
	Cold	2.71 / 2.36	2.68 / 2.34	2.63 / 2.29	2.67 / 2.31	2.62 / 2.27	2.64 / 2.06	2.61 / 2.03	2.71 / 2.37	2.67 / 2.33	2.70 / 2.36	2.68 / 2.34	2.66 / 2.32	2.63 / 2.29
Casing colour		Ivory white (5Y7.5/1)						Ivory white (5Y7.5/1)						
Compressor		Hermetically sealed scroll type						Hermetically sealed scroll type						
Motor output	kW	(4.44+5.03)+ (4.51+7.37)	(4.04+6.56)+ (4.51+7.37)	(4.51+7.37)+ (4.51+7.37)	(4.04+6.56)+ (7.80+8.11)	(4.51+7.37)+ (7.80+8.11)	(7.06+7.37)+ (7.80+8.11)	(7.80+8.11)+ (7.80+8.11)	7.67+(4.04+6.56)+ (4.51+7.37)	7.67+(4.51+7.37)+ (4.51+7.37)	8.45+(4.51+7.37)+ (4.51+7.37)	(4.44+5.03)+(4.51+7.37)+ (4.51+7.37)	(4.04+6.56)+(4.51+7.37)+ (4.51+7.37)	(4.51+7.37)+(4.51+7.37)+ (4.51+7.37)
	ℓ/s	4,428+5,095	4,293+5,095	5,095+5,095	4,293+7,170	5,095+7,170	7,170+7,170	7,170+7,170	3,015+4,293+5,095	3,015+5,095+5,095	4,327+5,095+5,095	4,428+5,095+5,095	4,293+5,095+5,095	5,095+5,095+5,095
Airflow rate	m <sup>3</sup> /min	266+306	258+306	306+306	258+430	306+430	430+430	430+430	181+258+306	181+306+306	260+306+306	266+306+306	258+306+306	306+306+306
	mm	(1,660×1,240×765) + (1,660×1,240×765)			(1,660×1,240×765) + (1,660×1,750×765)		(1,660×1,750×765) + (1,660×1,750×765)		(1,660×930×765) + (1,660×1,240×765) + (1,660×1,240×765)			(1,660×1,240×765) + (1,660×1,240×765) + (1,660×1,240×765)		
Machine weight	kg	323+357	357+357		357+409		409+409		232+357+357			281+357+357	323+357+357	357+357+357
Sound level	dB(A)	67	66	68	69	70	71	71	67	69			70	
Sound power	dB(A)	90	90	92	91	93	93	93	91	93			94	
Operation range	Cooling °CDB	-5 to 49						-5 to 49						
	Heating °CWB	-25 to 15.5						-25 to 15.5						
Refrigerant	Type	R-410A						R-410A						
	Charge kg	11.7+11.7						11.7+11.7+11.7						
Piping connections	Liquid mm	φ 19.1 (Brazing)						φ 19.1 (Brazing)						
	Gas mm	φ 41.3 (Brazing)						φ 41.3 (Brazing)						
	High and low pressure gas mm	φ 28.6 (Brazing)						φ 34.9 (Brazing)						

Notes: Specifications are based on the following conditions:  
 • Cooling: Indoor temp.: 27°CDB, 19°CWB, Outdoor temp.: 35°CDB, Equivalent piping length: 7.5 m, Height difference: 0 m.  
 • Heating: Indoor temp.: 20°CDB, Outdoor temp.: 7°CDB, 6°CWB, Equivalent piping length: 7.5 m, Height difference: 0 m.  
 • Sound level: Anechoic chamber conversion value, measured at a point 1 m in front of the unit at a height of 1.5 m.  
 During actual operation, these values are normally somewhat higher as a result of ambient conditions and oil recovery mode.  
 When there is concern for noise the surrounding area such as residences, we recommend investigating the installation location and taking soundproofing measures.  
 \* Values based on GEMS determination 2019.

**TCSPF: Total Cooling Seasonal Performance Factor**  
**HSPF: Heating Seasonal Performance Factor**  
 In simple terms, TCSPF & HSPF represents the ratio of the Total Cooling & Heating capacity of the air-conditioner relative to the Total energy consumed by the air-conditioner during the Total Cooling & Heating operation periods in a year.  
 Whereas the previous index of AEER & ACOP was calculated using only one representative outdoor temperature (35°C for cooling and 7°C for heating), the new index of TCSPF & HSPF uses a broader range of annual outdoor temperatures\* as stipulated in AS/NZS 3823.4.1:2014.  
 Further, the annual outdoor temperatures are based on zoning Australia/New Zealand into three distinct climate zones (Hot/Average/Cold). This allows you to determine the performance efficiency of different air-conditioners by comparing their TCSPF & HSPF within the same climate zone.  
 \* There are two kinds of annual outdoor temperatures and it's different for residential and commercial use.



# VRV H SERIES

Significant improvement in total performance

Heat Pump  
**8 class—60 class**  
(22.4 kW) (168 kW)



Promotion Movie



Special Site

New



Single outdoor units  
**RXYQ8-24BYM**

Double outdoor units  
**RXYQ26-48BYM**

Triple outdoor units  
**RXYQ50-60BYM**

Offers a wide variety of new functions that benefit everyone involved.

VRV H series enables cooling and heating operation with a single VRV system. VRV H series adopt a new casing to realise a single module of up to 24 class. In addition, the new models have achieved significant energy savings with improved technology. The operating performance has been improved in all directions by introducing unique ideas, technologies and a wide variety of functions to strengthen design flexibility, easy installation and reliability. We provide higher benefits to various users related to air conditioning systems, for example, building owners, consultants, installers and even building management.



# New Casing

Offers advanced design and new structure with excellent workability. The larger single module casing reduces installation cost and space also.



## Large-capacity single module

Single module reduces installation space

Conventional models VRV H SERIES	New models VRV H SERIES
<p>22, 24 class</p> <p>1,880 mm (930 mm + 20 mm + 930 mm) x 765 mm</p> <p>Installation space <b>1.44 m<sup>2</sup></b></p> <p>Machine weight <b>400 kg</b></p>	<p>22, 24 class</p> <p>1,750 mm x 765 mm</p> <p>Installation space <b>1.34 m<sup>2</sup></b></p> <p>Machine weight <b>385 kg</b></p> <p>Installation space <b>7% less</b> Machine weight <b>4% less</b></p>

## Outdoor unit combination

System capacity		Number of units	Single module (class)																
class	kW		8	10	12	14	16	18	20	22	24								
8	22.4	Single	●																
10	28.0			●															
12	33.5				●														
14	40.0					●													
16	45.0						●												
18	50.0							●											
20	56.0								●										
22	61.5									●									
24	67.0									●									
26	73.5	Double			●	●													
28	78.5				●		●												
30	83.5				●			●											
32	89.5				●				●										
34	96.0					●			●										
36	101						●			●									
38	106							●			●								
40	112								●		●								
42	117	Triple							●		●								
44	123									●		●							
46	128										●	●	●						
48	134											●	●	●					
50	139												●	●	●				
52	145													●	●	●			
54	152														●	●	●		
56	157															●	●	●	
58	162															●	●	●	
60	168																●	●	●

## New reinforced design

The frame structure has been strengthened to improve resistance to earthquakes and wind while protecting against falling damage.



- 1 Minimises horizontal wobbling**

Conventional models

VRV H SERIES

Support via truss shape
- 2 Minimises vibration from various angles**

Conventional models

VRV H SERIES

Each part is screwed with 2 axes



# Energy Savings

## High TCSPF / HSPF

Energy savings during actual operation have been further improved by the evolution of software and hardware technologies. Achieved high values for TCSPF and HSPF in all series.

### TCSPF (for commercial use)

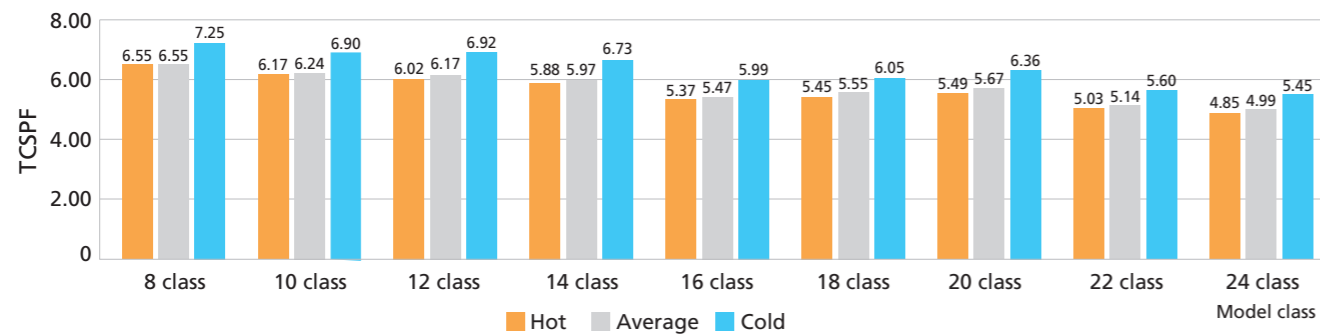

### HSPF (for commercial use)

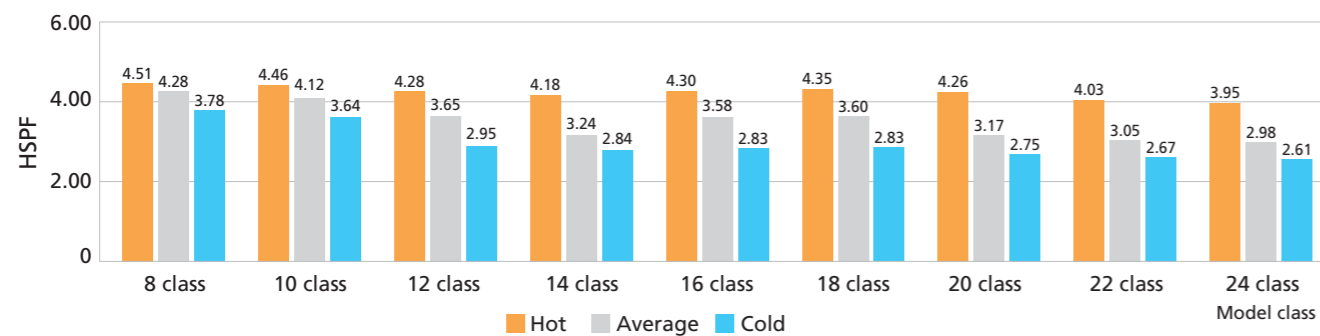

## Hardware technology High Efficiency Compressor

New technologies increase seasonal efficiency and enable a compact design.

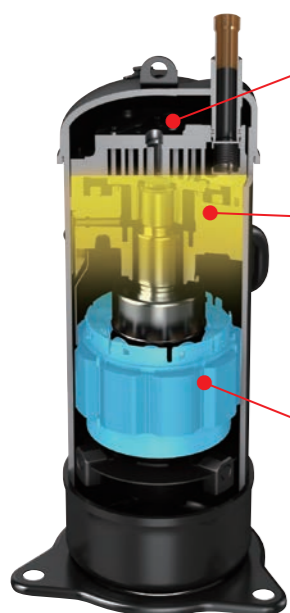

### Improvement of the discharge port

By improving the shape of the refrigerant discharge port, the pressure increase near the discharge port of the gas refrigerant after compression is suppressed and the compression loss is reduced.

### Optimising the back pressure control / New oil control function

In addition to the conventional intermediate pressure adjustment port, the pressing pressure of the orbiting scroll during operation has been optimised, and the newly adopted oil control mechanism has reduced gas leakage and mechanical loss.

### Adoption of a high-performance concentrated motor

By adopting it, the coil circumference is greatly reduced, which makes the coil denser and thicker, and the electrical resistance of the coil is dramatically reduced to improve motor efficiency. Furthermore, the motor is light-weighted and downsized.

## Software technology VRT Smart II control

Further improvement of energy savings is achieved due to optimal control of the outdoor airflow rate.

### Optimal supply exactly meets the required capacity of indoor units

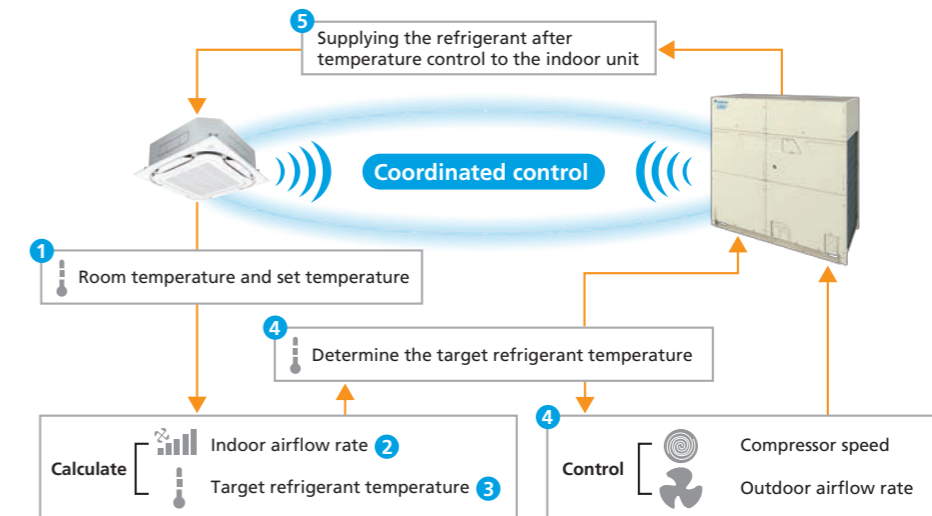

- 1 Indoor unit will calculate capacity needed based on  $\Delta T$  (Room temperature vs set temperature) and room temperature trend.
- 2 Indoor unit will try to regulate with fan speed control.
- 3 If fan cannot control speed, indoor unit request  $T_e$  change from outdoor unit.
- 4 Outdoor unit determines the refrigerant temperature based on the demands, and controls the compressor speed and outdoor airflow rate to change the refrigerant temperature.
- 5 The outdoor unit supplies the refrigerant adjusted to moderate temperature to the indoor unit.

## Optimal operating unit number in multi-system

- In outdoor multi-systems, the number of units operated is automatically controlled to ensure the best total efficiency according to the air-conditioning load.
- As the operating efficiency at low loads has been dramatically improved, the system controls each unit automatically in order to maintain operation at a lower load, operating at the highest possible efficiency.

### Overview of multi-unit control for triple units (60 class)

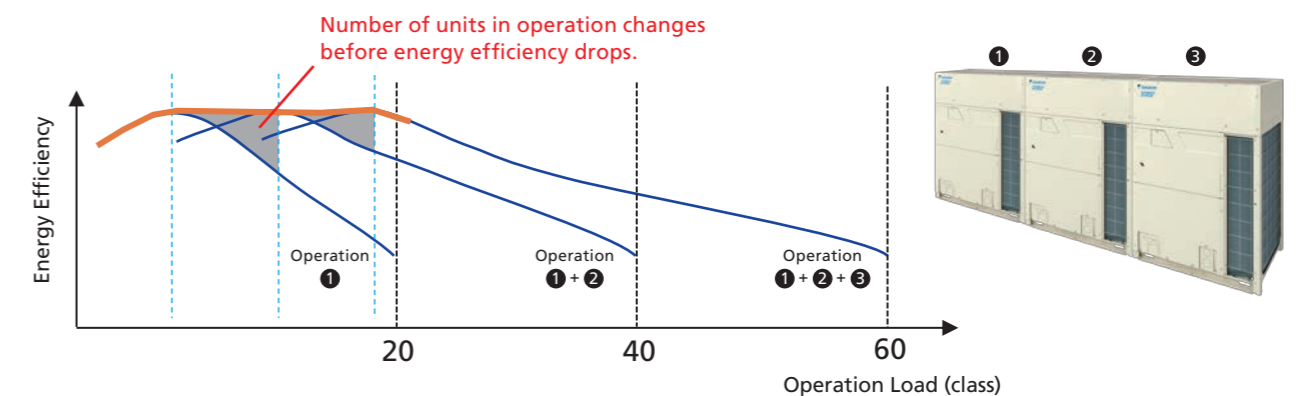

# Design Flexibility

## Simultaneous extension of height difference and equivalent length

Design flexibility is further improved by simultaneous extension of height difference, improved from 90 m to 110 m, and equivalent length (up to 190 m).

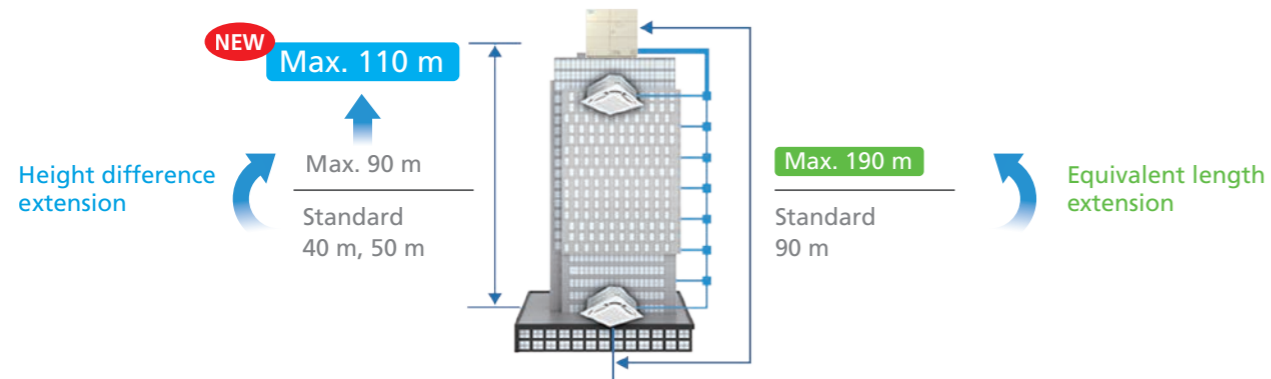

### • Height difference extension **Max. 110 m**

For height differences exceeding 50 m with the outdoor unit above the indoor unit and 40 m with the outdoor unit below, the main liquid piping size must be increased.

The operating temperature range is up to 49°C (Outdoor units above indoor units only).  
The minimum connection capacity index of the indoor unit shall be 63 or more (Outdoor units above indoor units only).

### • Equivalent length **Max. 190 m**

When the equivalent piping length from outdoor unit to indoor unit is 90 m or more, be sure to increase the size of the liquid and gas pipes of the main piping.

\* In addition to increasing the size of the main pipe, there are other piping restrictions regarding height difference extension and equivalent length. Check the Installation Manual for details.

## REFNET header downstream branching supported

Piping branch by REFNET joint is possible downstream of REFNET header. The indoor unit arrangement can be more flexible.

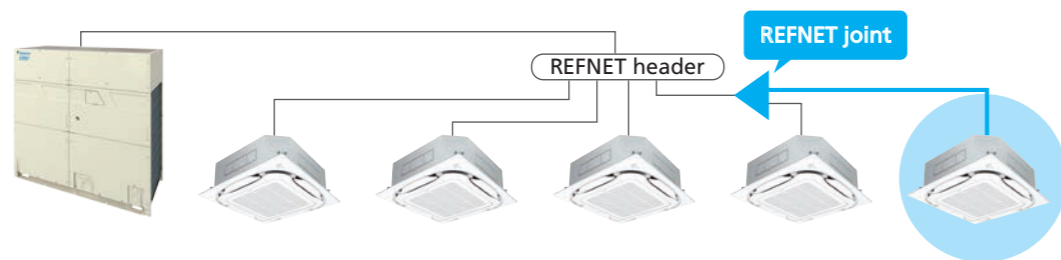

REFNET header	Indoor unit total capacity at REFNET joint
KHRP26M22H, KHRP26M33H, KHRP26M72H	< 50
KHRP26M73H + KHRP26M73HP	≤ 140

## Long piping length

Long piping length enhances design flexibility, enabling support for large buildings

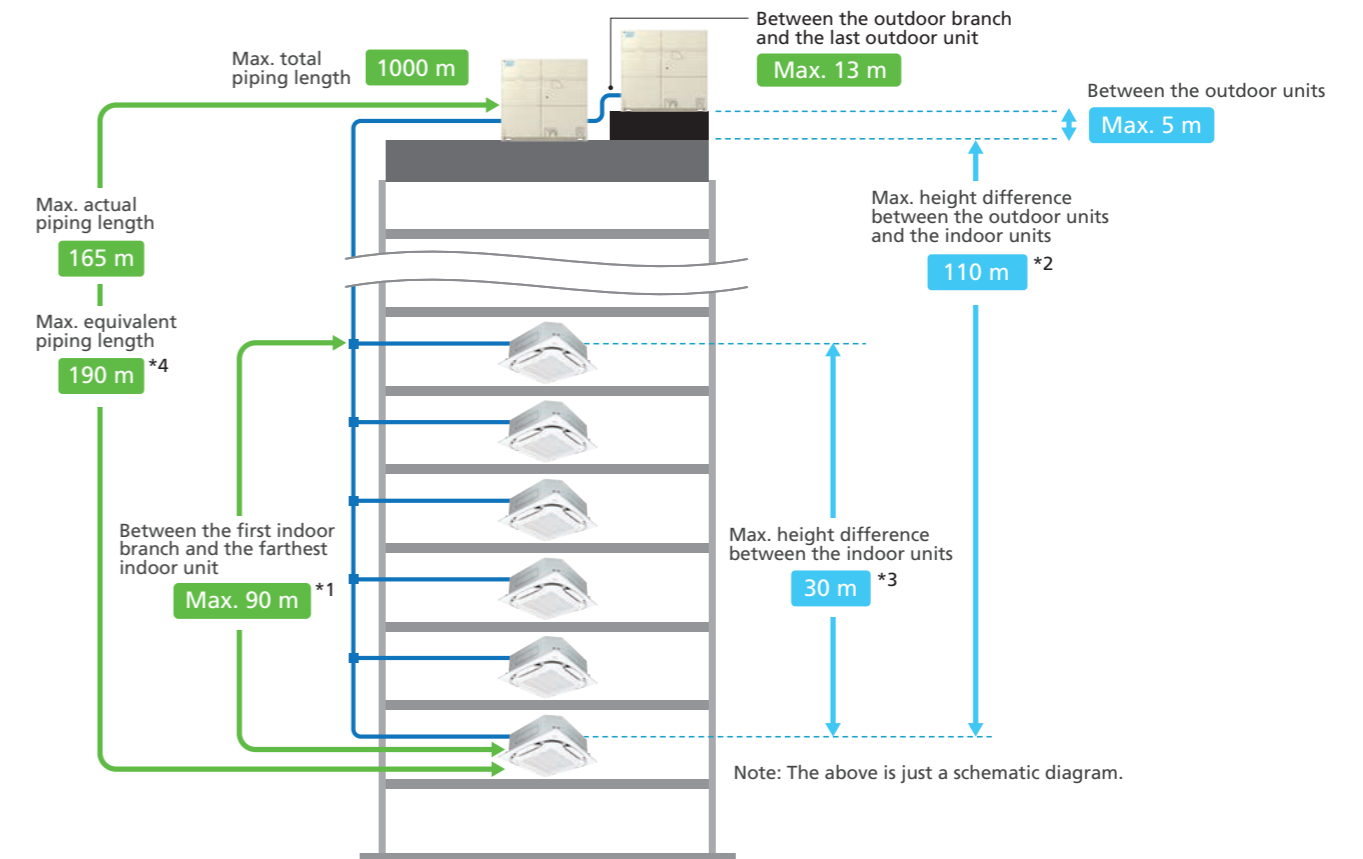

Maximum allowable piping length	Actual piping length (Equivalent)	165 m (190 m) <sup>*4</sup>
	Total piping length	1000 m
	Between the first indoor branch and the farthest indoor unit	90 m <sup>*1</sup>
Maximum allowable height difference	Between the outdoor branch and the last outdoor unit (Equivalent)	10 m (13 m)
	Between the outdoor units (Multiple use)	5 m
	Between the indoor units	30 m <sup>*3</sup>
	Between the outdoor units and the indoor units	110 m <sup>*2</sup>

\*1. No special requirements up to 40 m. The maximum actual piping length can be 90 m, depending on conditions. Various conditions and requirements have to be met to allow utilisation of 90 m piping length. Be sure to refer to the Engineering Data Book for details of these conditions and requirements.  
 \*2. When Height differences above 50 m if the outdoor unit is above the indoor unit and 40 m if the outdoor unit is below the indoor unit, a dedicated setting on the outdoor unit is required. Refer to the Engineering Data Book and contact your local dealer for more information.  
 \*3. When Height differences are 15 m or more, maximum actual piping length must be 120 m.  
 \*4. If equivalent piping length from outdoor unit to indoor unit is 90 m or more, make sure to size up the liquid and gas pipes of the main piping.



# Design Flexibility

## ■ Connection ratio

Connection capacity at maximum is 200%.

Connection ratio  
**50%–200%**

$$\text{Connection ratio} = \frac{\text{Total capacity index of the indoor units}}{\text{Capacity index of the outdoor units}}$$

Conditions of **VRV** indoor unit connection capacity

Applicable <b>VRV</b> indoor units	Indoor units				Other <b>VRV</b> indoor unit models*1	
	FXDQ	FXSQ	FXMQ-PA	FXAQ		
Single outdoor units	<b>200%</b>				8 - 20 class	<b>200%</b>
					22, 24 class	<b>180%</b>
Double outdoor units					<b>160%</b>	
Triple outdoor units					<b>130%</b>	

\*1 For the FXF(S)(T)Q25 models, maximum connection ratio is 130 % for the entire range of outdoor units.  
Note: If the operational capacity of indoor units is more than 130%, low airflow operation is enforced in all the indoor units.  
\*Refer to page 53 for outdoor unit combination details.

# Easy Installation

## ■ Process visualization (Test run only\*)

In the new models, in addition to the actual step (t01 to t10), a progress rate (0% to 99%) is available as a guideline when making arrangements for on-site work.

\* Effective when test run is carried out independently after manual refrigerant charging.

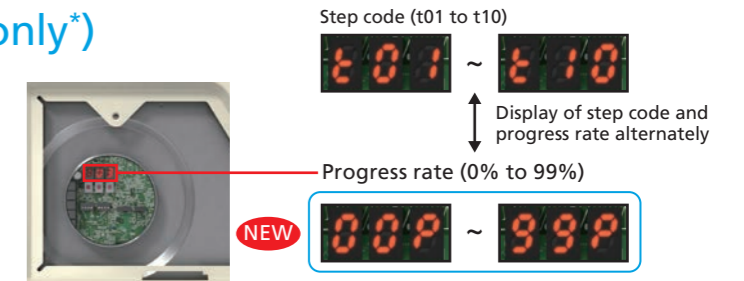

## ■ Electrical component service window

An electrical component service window is newly installed on the front panel. Main PCB 7-segment LED can be accessed without removing the front panel.

Workability is greatly improved during on-site setting or test run. You can also quickly check the error code during service.



## ■ Improved refrigerant piping workability

By dividing piping and wiring holes to the left and right, piping and wiring work can be easily performed on site.

Conventional models



Working in closed place is difficult

**VRV H**



Work becomes easier with sufficient space

## IP55-compliant sealed component box

IP55 sealed component box protects electrical component from a cause of failure, that is the ingress of debris (lizards, bugs, sand, water, snow).

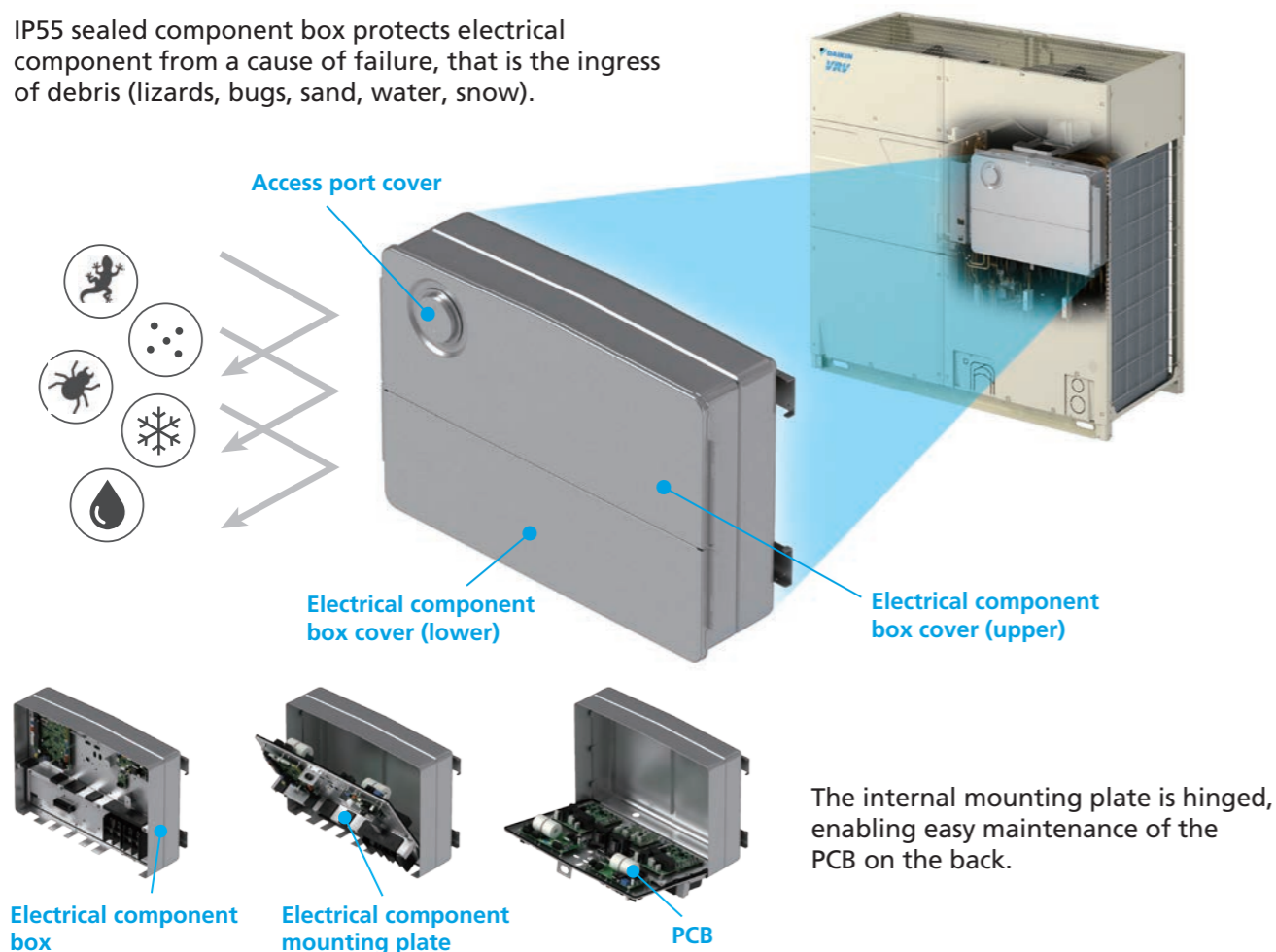

## Enables operation in high outdoor temperature

Three refrigerant cooling circuits enable stable operation even in high outdoor temperatures by suppressing a temperature rise for the PCB mounted in the sealed electrical component box.

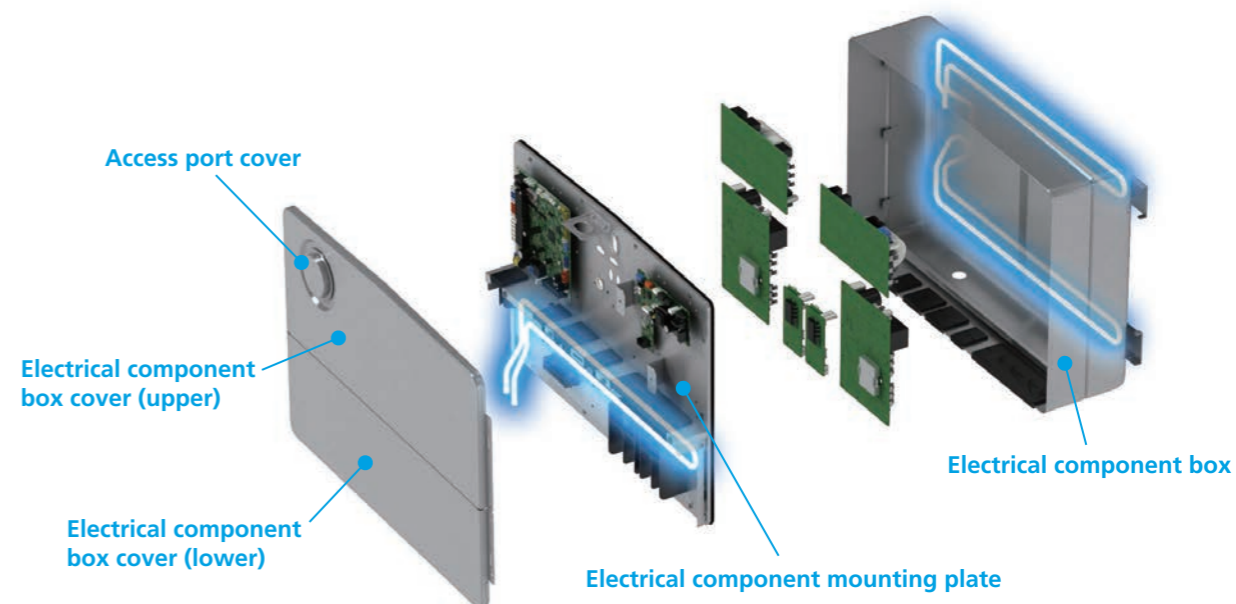

## What is IP55?

IP55 is the degrees of dust and water protection for the electrical component box equipped on the product.

### IP55

#### Liquid ingress protection **Grade 5**

Water projected by a nozzle (6.3 mm) against enclosure from any direction shall have no harmful effects.

#### Solid particle protection **Grade 5**

Ingress of dust is not entirely prevented, but it must not enter in sufficient quantity to interfere with the satisfactory operation of the equipment.

Ingress Protection

\*IP55 is the protection degree of the wiring box as a single unit. The protection grade of outdoor unit is IP14 as well as conventional model.

## Extended operation temperature range

Operation is now possible on a wider range of outdoor temperatures.

Upper limit up to 52°CDB in Cooling mode  
Lower limit down to -25°CWB in Heating mode

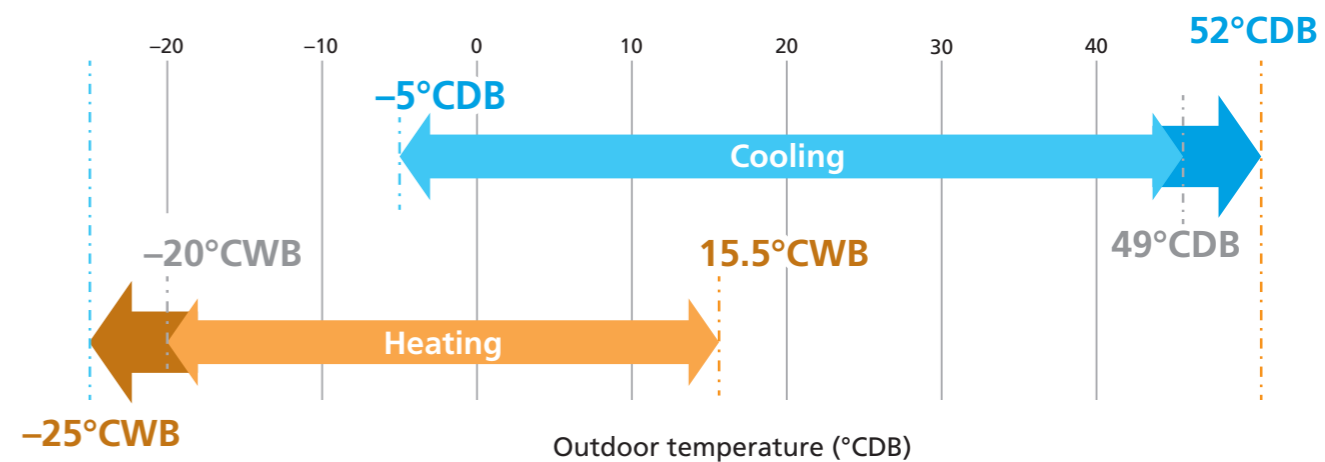



## Defrost learning function

If defrost operation time is short, the system will optimise defrost start conditions for the next cycle, improving comfort by extending the heating operation time.

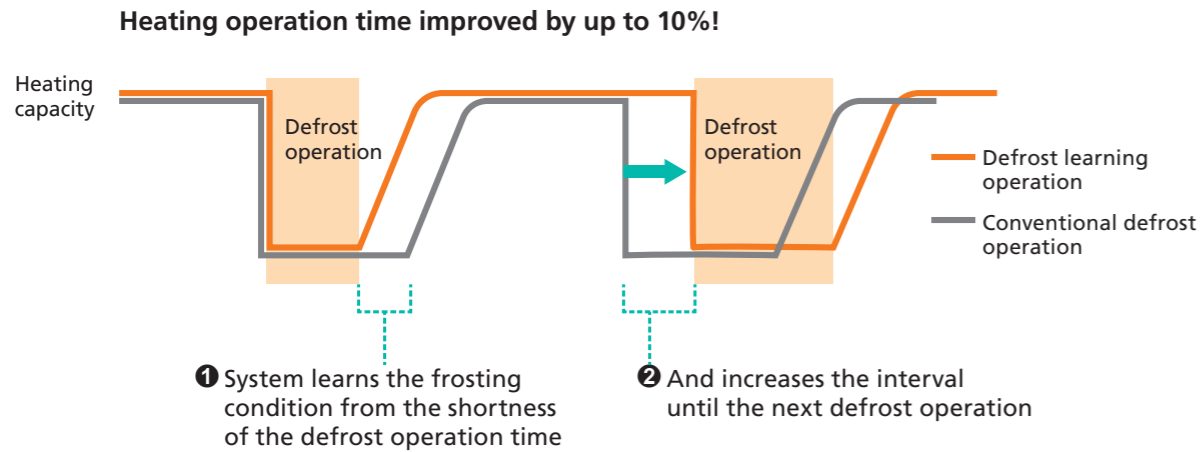

## Defrost before stop

Defrost operation before the equipment is shut down speeds up the increase of discharge air temperature of the next heating operation, and extends the continuous heating operation time after restarting, thereby improving comfort.

Heating operation time is improved by up to 30%!

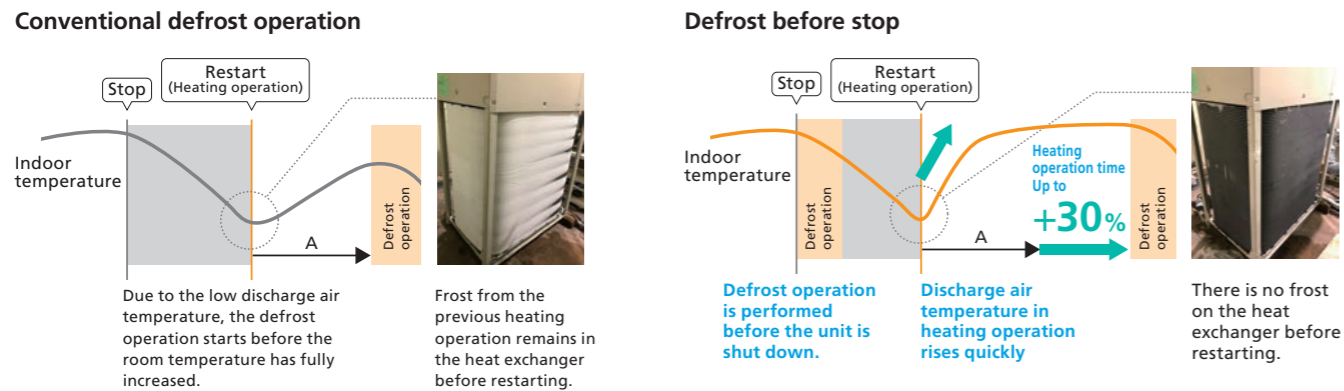

\* Conditions for effectiveness estimation : Outdoor air temperature 2°C  
Round flow cassette with sensing operating at 100% capacity

## Double backup operation functions

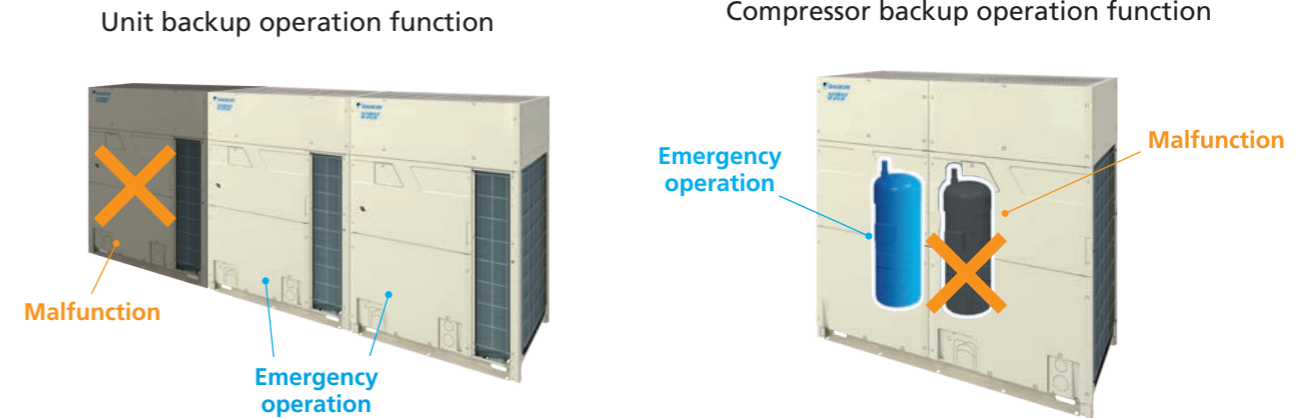

## Nighttime quiet operation function

The nighttime quiet operation function automatically suppresses the nighttime operating sound by reducing operation capacity to maintain the quiet environment of the neighborhood. Three selectable modes are available depending on the required level.

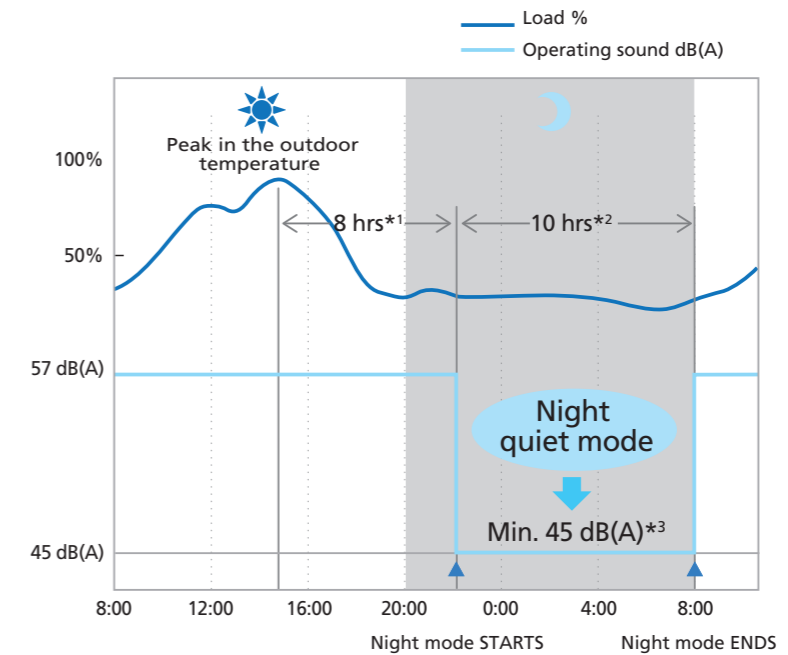

\*1. Initial setting is 8 hours. Can be selected from 6, 8 and 10 hours.  
\*2. Initial setting is 9 hours. Can be selected from 8, 9 and 10 hours.  
\*3. In case of 10 class outdoor unit.

Notes: • This function is available in setting at site.  
• The operating sound in quiet operation mode is the actual value measured by our company.  
• The relationship of outdoor temperature (load) and time shown above is just an example.

# Outdoor Unit Lineup

## VRV H Series

### Capacity range from 8 to 60 class

#### Lineup

class	8	10	12	14	16	18	20	22	24	26	28	30	32	34	36	38	40	42	44	46	48	50	52	54	56	58	60		
Single outdoor units	●	●	●	●	●	●	●	●	●																				
Double outdoor units										●	●	●	●	●	●	●	●	●	●	●	●	●							
Triple outdoor units																							●	●	●	●	●	●	

### Outdoor unit combinations

class	kW	Capacity index	Model name	Combination	Outdoor unit multi connection piping kit*1	Total capacity index of connectable indoor units*2	Maximum number of connectable indoor units*2
8	22.4	200	RXYQ8B	RXYQ8B	-	100 to 260 (400)	13 (20)
10	28.0	250	RXYQ10B	RXYQ10B	-	125 to 325 (500)	16 (25)
12	33.5	300	RXYQ12B	RXYQ12B	-	150 to 390 (600)	19 (30)
14	40.0	350	RXYQ14B	RXYQ14B	-	175 to 455 (700)	22 (35)
16	45.0	400	RXYQ16B	RXYQ16B	-	200 to 520 (800)	26 (40)
18	50.0	450	RXYQ18B	RXYQ18B	-	225 to 585 (900)	29 (45)
20	56.0	500	RXYQ20B	RXYQ20B	-	250 to 650 (1,000)	32 (50)
22	61.5	550	RXYQ22B	RXYQ22B	-	275 to 715 (990)	35 (49)
24	67.0	600	RXYQ24B	RXYQ24B	-	300 to 780 (1,080)	39 (54)
26	73.5	650	RXYQ26B	RXYQ12B + RXYQ14B	BHFP22R135	325 to 845 (1,040)	42 (52)
28	78.5	700	RXYQ28B	RXYQ12B + RXYQ16B		350 to 910 (1,120)	45 (56)
30	83.5	750	RXYQ30B	RXYQ12B + RXYQ18B		375 to 975 (1,200)	48 (60)
32	89.5	800	RXYQ32B	RXYQ12B + RXYQ20B		400 to 1,040 (1,280)	52 (64)
34	96.0	850	RXYQ34B	RXYQ14B + RXYQ20B		425 to 1,105 (1,360)	55 (64)
36	101	900	RXYQ36B	RXYQ16B + RXYQ20B		450 to 1,170 (1,440)	58 (64)
38	106	950	RXYQ38B	RXYQ18B + RXYQ20B		475 to 1,235 (1,520)	61 (64)
40	112	1,000	RXYQ40B	RXYQ20B × 2		500 to 1,300 (1,600)	64 (64)
42	117	1,050	RXYQ42B	RXYQ20B + RXYQ22B		525 to 1,365 (1,680)	
44	123	1,100	RXYQ44B	RXYQ20B + RXYQ24B		550 to 1,430 (1,760)	
46	128	1,150	RXYQ46B	RXYQ22B + RXYQ24B		575 to 1,495 (1,840)	
48	134	1,200	RXYQ48B	RXYQ24B × 2		600 to 1,560 (1,920)	
50	139	1,250	RXYQ50B	RXYQ12B + RXYQ18B + RXYQ20B		625 to 1,625 (1,625)	
52	145	1,300	RXYQ52B	RXYQ12B + RXYQ20B × 2		650 to 1,690 (1,690)	
54	152	1,350	RXYQ54B	RXYQ14B + RXYQ20B × 2	675 to 1,755 (1,755)		
56	157	1,400	RXYQ56B	RXYQ16B + RXYQ20B × 2	700 to 1,820 (1,820)		
58	162	1,450	RXYQ58B	RXYQ18B + RXYQ20B × 2	725 to 1,885 (1,885)		
60	168	1,500	RXYQ60B	RXYQ20B × 3	750 to 1,950 (1,950)		

Notes: \*1. For multiple connection of 26 class systems and above, the outdoor unit multi connection piping kit (separately sold) is required.  
 \*2. Values inside brackets are based on connection of indoor units rated at maximum capacity, 200% for RXYQ8-20BYM, 180% for RXYQ22/24BYM, 160% for double outdoor units, and 130% for triple outdoor units. Refer to page 47 for note on connection capacity of indoor units.

# Indoor Unit Lineup

### Enhanced range of choices

Category	Type	Model Name	Capacity Range(kW)	Capacity Index																											
				20	25	31.25	40	50	62.5	71	80	100	125	140	145	160	180	200	250												
Ceiling Mounted Cassette	Round Flow Cassette with Sensing and Streamer	New FXFTQ-AVM	20-25	●	●	●	●	●	●	●	●	●	●	●	●	●	●	●	●	●	●	●	●	●	●	●	●	●	●		
	Round Flow Cassette with Sensing	FXFSQ-AVM	20-25	●	●	●	●	●	●	●	●	●	●	●	●	●	●	●	●	●	●	●	●	●	●	●	●	●	●	●	
	Round Flow Cassette	FXFQ-AVM	20-25	●	●	●	●	●	●	●	●	●	●	●	●	●	●	●	●	●	●	●	●	●	●	●	●	●	●	●	
	Compact Multi Flow Cassette	New FXZQ-BVM	20-25	●	●	●	●	●	●	●	●	●	●	●	●	●	●	●	●	●	●	●	●	●	●	●	●	●	●	●	
	Double Flow Cassette	New FXCQ-BVM	20-25	●	●	●	●	●	●	●	●	●	●	●	●	●	●	●	●	●	●	●	●	●	●	●	●	●	●	●	
Ceiling Concealed Duct	Slim Duct (Standard)	FXDQ-PDVE	20-25	●	●	●	●	●	●	●	●	●	●	●	●	●	●	●	●	●	●	●	●	●	●	●	●	●	●	●	
		FXDQ-NDVE	20-25	●	●	●	●	●	●	●	●	●	●	●	●	●	●	●	●	●	●	●	●	●	●	●	●	●	●	●	●
	Slim Duct (Compact)	FXDQ-TV1C(A)	20-25	●	●	●	●	●	●	●	●	●	●	●	●	●	●	●	●	●	●	●	●	●	●	●	●	●	●	●	
	Middle Static Pressure Duct	FXSQ-PAVE	20-25	●	●	●	●	●	●	●	●	●	●	●	●	●	●	●	●	●	●	●	●	●	●	●	●	●	●	●	●
		FXDYQ-MAV1	20-25	●	●	●	●	●	●	●	●	●	●	●	●	●	●	●	●	●	●	●	●	●	●	●	●	●	●	●	●
	Middle-High Static Pressure Duct	FXMQ-PAVE	20-25	●	●	●	●	●	●	●	●	●	●	●	●	●	●	●	●	●	●	●	●	●	●	●	●	●	●	●	●
	High Static Pressure Duct	FXMQ-PV1A	20-25	●	●	●	●	●	●	●	●	●	●	●	●	●	●	●	●	●	●	●	●	●	●	●	●	●	●	●	●
	Ceiling Suspended	Outdoor-Air Processing Unit	FXMQ-MFV1	20-25	●	●	●	●	●	●	●	●	●	●	●	●	●	●	●	●	●	●	●	●	●	●	●	●	●	●	●
		4-Way Flow Ceiling Suspended	New FXMQ-AFVM	20-25	●	●	●	●	●	●	●	●	●	●	●	●	●	●	●	●	●	●	●	●	●	●	●	●	●	●	●
	Wall Mounted	Ceiling Suspended	FXUQ-AVEB	20-25	●	●	●	●	●	●	●	●	●	●	●	●	●	●	●	●	●	●	●	●	●	●	●	●	●	●	●
FXHQ-MAVE			20-25	●	●	●	●	●	●	●	●	●	●	●	●	●	●	●	●	●	●	●	●	●	●	●	●	●	●	●	●
Floor Standing	4-Way Flow Ceiling Suspended	New FXHQ-BVM	20-25	●	●	●	●	●	●	●	●	●	●	●	●	●	●	●	●	●	●	●	●	●	●	●	●	●	●	●	●
	Floor Standing	FXAQ-AVM	20-25	●	●	●	●	●	●	●	●	●	●	●	●	●	●	●	●	●	●	●	●	●	●	●	●	●	●	●	●
Heat Reclaim Ventilator	Floor Standing	FXLQ-MAVE	20-25	●	●	●	●	●	●	●	●	●	●	●	●	●	●	●	●	●	●	●	●	●	●	●	●	●	●	●	●
	Concealed Floor Standing	FXNQ-MAVE	20-25	●	●	●	●	●	●	●	●	●	●	●	●	●	●	●	●	●	●	●	●	●	●	●	●	●	●	●	●
Airflow rate 150-2000 m³/h																															

Notes: For indoor units without 'VRT Smart', the standard 'VRT' control is available (excludes Heat Reclaim Ventilators).

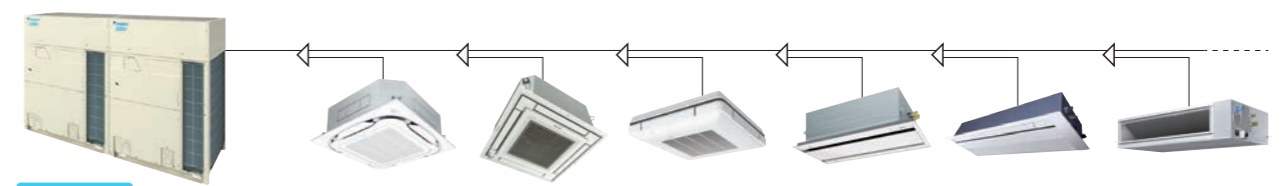

- Max. 64 indoor units
- If a system has indoor units subject to both VRT smart and VRT control, the system is operated under VRT control.
- If a system has both outdoor-air processing air conditioners (FXMQ-MF series) and outdoor-air processing type indoor units, VRT smart control and VRT control are disabled.



# Outdoor Unit Specifications

## Specifications

\* Values based on GEMS determination 2019.

**TCSPF: Total Cooling Seasonal Performance Factor**  
**HSPF: Heating Seasonal Performance Factor**  
 In simple terms, TCSPF & HSPF represents the ratio of the Total Cooling & Heating capacity of the air-conditioner relative to the Total energy consumed by the air-conditioner during the Total Cooling & Heating operation periods in a year.  
 Whereas the previous index of AER & ACOP was calculated using only one representative outdoor temperature (35°C for cooling and 7°C for heating), the new index of TCSPF & HSPF uses a broader range of annual outdoor temperatures\* as stipulated in AS/NZS 3823.4.1:2014.  
 Further, the annual outdoor temperatures are based on zoning Australia/ New Zealand into three distinct climate zones (Hot/Average/Cold). This allows you to determine the performance efficiency of different air-conditioners by comparing their TCSPF & HSPF within the same climate zone.  
 \* There are two kinds of annual outdoor temperatures and it's different for residential and commercial use.

Heat Pump

Model	RXYQ8BYM	RXYQ10BYM	RXYQ12BYM	RXYQ14BYM	RXYQ16BYM	RXYQ18BYM	RXYQ20BYM	RXYQ22BYM	RXYQ24BYM	RXYQ26BYM	RXYQ28BYM	RXYQ30BYM	RXYQ32BYM	RXYQ34BYM					
Combination units	—	—	—	—	—	—	—	—	—	RXYQ12BYM	RXYQ12BYM	RXYQ12BYM	RXYQ12BYM	RXYQ14BYM					
Power supply	3-phase 4-wire system, 380-415 V/380 V, 50/60 Hz							3-phase 4-wire system, 380-415 V/380 V, 50/60 Hz											
Cooling capacity	Btu/h	76,400	95,500	114,000	136,000	154,000	171,000	191,000	210,000	229,000	250,000	268,000	285,000	305,000	327,000				
	kW	22.4	28.0	33.5	40.0	45.0	50.0	56.0	61.5	67.0	73.5	78.5	83.5	89.5	96.0				
Heating capacity	Btu/h	85,300	107,000	128,000	154,000	171,000	191,000	215,000	235,000	256,000	282,000	299,000	319,000	343,000	369,000				
	kW	25.0	31.5	37.5	45.0	50.0	56.0	63.0	69.0	75.0	82.5	87.5	93.5	100	108				
Power consumption	Cooling	5.17	6.81	8.70	10.7	13.3	14.3	16.9	18.6	21.6	19.4	22.0	23.0	25.6	27.6				
	Heating	5.33	6.99	9.67	11.0	13.5	14.9	17.0	19.6	22.2	20.7	23.2	24.6	26.7	28.0				
Capacity control	%	11-100	13-100	12-100	7-100	5-100	4-100	5-100	7-100	6-100	7-100	7-100	7-100	6-100					
AEER	Cooling	4.00	3.83	3.61	3.49	3.18	3.29	3.12	3.12	2.94	3.53	3.35	3.40	3.29	3.26				
	Heating	4.33	4.20	3.66	3.82	3.49	3.54	3.33	3.33	3.21	3.74	3.58	3.61	3.58	3.65				
TCSPF (Cooling)	Hot	6.55/5.69	6.17/5.42	6.02/5.26	5.88/5.07	5.37/4.77	5.45/4.86	5.49/4.18	5.03/4.53	4.85/4.37	5.94/5.16	5.63/4.97	5.67/5.02	5.68/4.98	5.65/4.92				
	Average	6.55/4.63	6.24/4.55	6.17/4.48	5.97/4.20	5.47/4.04	5.55/4.14	5.67/4.13	5.14/3.95	4.99/3.84	6.06/4.33	5.75/4.23	5.78/4.28	5.85/4.26	5.79/4.16				
	Cold	7.25/4.58	6.90/4.53	6.92/4.52	6.73/4.19	5.99/4.09	6.05/4.19	6.36/4.21	5.60/4.01	5.45/3.93	6.82/4.34	6.36/4.27	6.37/4.32	6.56/4.33	6.51/4.21				
HSPF (Heating)	Hot	4.51/4.53	4.46/4.47	4.28/4.29	4.18/4.19	4.30/4.30	4.35/4.35	4.26/4.26	4.03/3.96	3.95/3.88	4.23/4.24	4.29/4.30	4.33/4.33	4.27/4.27	4.23/4.23				
	Average	4.28/4.17	4.12/3.99	3.65/3.16	3.24/3.05	3.58/3.03	3.60/3.03	3.17/2.94	3.05/2.51	2.98/2.44	3.60/3.11	3.61/3.09	3.62/3.09	3.56/3.02	3.21/2.99				
	Cold	3.78/3.54	3.64/3.32	2.95/2.60	2.84/2.48	2.83/2.45	2.83/2.44	2.75/2.36	2.67/2.08	2.61/2.03	2.89/2.54	2.88/2.52	2.88/2.51	2.82/2.44	2.79/2.41				
Casing colour		Ivory white (5Y7.5/1)							Ivory white (5Y7.5/1)										
Compressor	Type	Hermetically sealed scroll																	
	Motor output	kW	4.3	6.2	7.7	3.9+4.4	4.4+5.0	4.0+6.6	4.5+7.4	7.0+7.3	7.7+8.0	7.7+(3.9+4.4)	7.7+(4.4+5.0)	7.7+(4.0+6.6)	7.7+(4.5+7.4)	(3.9+4.4)+(4.5+7.4)			
Airflow rate	ℓ/s	2,583	2,817	3,017	4,333	4,433	4,300	5,100	7,167	7,167	3,017+4,333	3,017+4,433	3,017+4,300	3,017+5,100	4,333+5,100				
	m³/min	155	169	181	260	266	258	306	430	430	181+260	181+266	181+258	181+306	260+306				
Dimensions (HxWxD)	mm	1,660x930x765			1,660x1,240x765				1,660x1,750x765			(1,660x930x765)+(1,660x1,240x765)				(1,660x1,240x765)+(1,660x1,240x765)			
Machine weight	kg	215	225	310	310	340	340	340	385	385	225+310	225+310	225+340	225+340	310+340				
Sound level (Cooling/Heating)	dB(A)	56/56	57/58	60/62	61/61	61/61	65/66	65/66	67/67	68/68	64/65	64/65	64/65	66/67	66/67				
Sound power	dB	78	79	83	83	85	90	90	90	90	86	87	87	91	91				
Operation range	Cooling	-5 to 52																	
	Heating	-25 to 15.5																	
Refrigerant	Type	R-410A																	
	Charge	kg	6.9	7.1	7.2	9.7	9.9	11.7	11.7	11.7	7.2+9.7	7.2+9.9	7.2+11.7	7.2+11.7	9.7+11.7				
Piping connections	Liquid	φ9.5 (Brazing)																	
	Gas	φ19.1 (Brazing)			φ22.2 (Brazing)			φ12.7 (Brazing)				φ15.9 (Brazing)			φ19.1 (Brazing)			φ28.6 (Brazing)	

Model	RXYQ36BYM	RXYQ38BYM	RXYQ40BYM	RXYQ42BYM	RXYQ44BYM	RXYQ46BYM	RXYQ48BYM	RXYQ50BYM	RXYQ52BYM	RXYQ54BYM	RXYQ56BYM	RXYQ58BYM	RXYQ60BYM			
Combination units	RXYQ16BYM	RXYQ18BYM	RXYQ20BYM	RXYQ20BYM	RXYQ20BYM	RXYQ22BYM	RXYQ24BYM	RXYQ12BYM	RXYQ12BYM	RXYQ14BYM	RXYQ16BYM	RXYQ18BYM	RXYQ20BYM			
Power supply	3-phase 4-wire system, 380-415 V/380 V, 50/60 Hz							3-phase 4-wire system, 380-415 V/380 V, 50/60 Hz								
Cooling capacity	Btu/h	345,000	362,000	382,000	401,000	420,000	439,000	458,000	476,000	496,000	518,000	536,000	553,000	573,000		
	kW	101	106	112	117	123	128	134	139	145	152	157	162	168		
Heating capacity	Btu/h	386,000	406,000	430,000	450,000	471,000	491,000	512,000	534,000	558,000	584,000	601,000	621,000	645,000		
	kW	113	119	126	132	138	144	150	156	163	171	176	182	189		
Power consumption	Cooling	30.2	31.2	33.8	35.5	38.5	40.2	43.2	39.9	42.5	44.5	47.1	48.1	50.7		
	Heating	30.5	31.9	34.0	37.1	39.2	41.8	44.4	41.6	43.7	45.0	47.5	48.9	51.0		
Capacity control	%	5-100			4-100			5-100			6-100			5-100		
AEER	Cooling	3.15	3.20	3.13	3.13	3.03	3.03	2.94	3.29	3.23	3.21	3.14	3.17	3.13		
	Heating	3.53	3.56	3.54	3.45	3.37	3.31	3.25	3.58	3.57	3.61	3.53	3.55	3.54		
TCSPF (Cooling)	Hot	5.44/4.80	5.47/4.84	5.49/4.82	5.23/4.66	5.12/4.57	4.93/4.44	4.85/4.37	5.59/4.93	5.60/4.91	5.59/4.88	5.46/4.81	5.48/4.83	5.49/4.82		
	Average	5.58/4.10	5.61/4.14	5.67/4.13	5.38/4.03	5.28/3.97	5.06/3.89	4.99/3.84	5.73/4.22	5.78/4.21	5.75/4.15	5.61/4.11	5.63/4.14	5.67/4.13		
	Cold	6.19/4.16	6.21/4.21	6.36/4.22	5.94/4.11	5.83/4.06	5.52/3.97	5.45/3.93	6.37/4.28	6.48/4.28	6.45/4.21	6.25/4.18	6.26/4.21	6.36/4.22		
HSPF (Heating)	Hot	4.28/4.28	4.30/4.30	4.26/4.26	4.14/4.14	4.09/4.09	4.00/3.92	3.96/3.88	4.30/4.30	4.27/4.27	4.24/4.24	4.27/4.27	4.29/4.29	4.26/4.26		
	Average	3.21/2.98	3.55/2.99	3.18/2.95	3.12/2.90	3.07/2.85	3.02/2.48	2.98/2.45	3.58/3.03	3.54/2.99	3.20/2.98	3.20/2.97	3.54/2.98	3.18/2.95		
	Cold	2.79/2.40	2.79/2.40	2.76/2.36	2.72/2.35	2.68/2.30	2.64/2.06	2.61/2.03	2.83/2.44	2.80/2.41	2.78/2.40	2.78/2.39	2.78/2.39	2.76/2.36		
Casing colour		Ivory white (5Y7.5/1)							Ivory white (5Y7.5/1)							
Compressor	Type	Hermetically sealed scroll type														
	Motor output	kW	(4.4+5.0)+(4.5+7.4)	(4.0+6.6)+(4.5+7.4)	(4.5+7.4)+(4.5+7.4)	(4.5+7.4)+(7.0+7.3)	(4.5+7.4)+(7.7+8.0)	(7.0+7.3)+(7.7+8.0)	(7.7+8.0)+(7.7+8.0)	7.7+(4.0+6.6)+(4.5+7.4)	7.7+(4.5+7.4)+(4.5+7.4)	(3.9+4.4)+(4.5+7.4)+(4.5+7.4)	(4.4+5.0)+(4.5+7.4)+(4.5+7.4)	(4.0+6.6)+(4.5+7.4)+(4.5+7.4)	(4.5+7.4)+(4.5+7.4)+(4.5+7.4)	
Airflow rate	ℓ/s	4,433+5,100	4,300+5,100	5,100+5,100	5,100+7,167	5,100+7,167	7,167+7,167	7,167+7,167	3,017+4,300+5,100	3,017+5,100+5,100	4,333+5,100+5,100	4,433+5,100+5,100	4,300+5,100+5,100	5,100+5,100+5,100		
	m³/min	266+306	258+306	306+306	306+430	306+430	430+430	430+430	181+258+306	181+306+306	260+306+306	266+306+306	258+306+306	306+306+306		
Dimensions (HxWxD)	mm	(1,660x1,240x765)+(1,660x1,240x765)			(1,660x1,240x765)+(1,660x1,750x765)			(1,660x1,750x765)+(1,660x1,750x765)			(1,660x930x765)+(1,660x1,240x765)+(1,660x1,240x765)					
Machine weight	kg	310+340	340+340	340+385	340+385	385+385	385+385	385+385	225+340+340	225+340+340	310+340+340	310+340+340	340+340+340	340+340+340		
Sound level (Cooling/Heating)	dB(A)	66/67	66/67	68/69	69/70	70/70	71/71	71/71	67/68	68/68	69/70	69/70	70/71	70/71		
Sound power	dB	91	91	93	93	93	93	92	92	93	93	94	94	95		
Operation range	Cooling	-5 to 52														
	Heating	-25 to 15.5														
Refrigerant	Type	R-410A														
	Charge	kg	9.9+11.7	11.7+11.7	11.7+11.7	11.7+11.7	11.7+11.7	11.7+11.7	7.2+11.7+11.7	7.2+11.7+11.7	9.7+11.7+11.7	9.9+11.7+11.7	11.7+11.7+11.7	11.7+11.7+11.7		
Piping connections	Liquid	φ19.1 (Brazing)														
	Gas	φ19.1 (Brazing)			φ22.2 (Brazing)			φ12.7 (Brazing)			φ15.9 (Brazing)			φ19.1 (Brazing)		

Notes: Specifications are based on the following conditions;

- Cooling: Indoor temp.: 27°CDB, 19°CWB, Outdoor temp.: 35°CDB, Equivalent piping length: 7.5 m, Height difference: 0 m.
- Heating: Indoor temp.: 20°CDB, Outdoor temp.: 7°CDB, 6°CWB, Equivalent piping length: 7.5 m, Height difference: 0 m.

\* Sound level: Anechoic chamber conversion value, measured at a point 1 m in front of the unit at a Height of 1.5 m.

During actual operation, these values are normally somewhat higher as a result of ambient conditions and oil recovery mode. When there is concern for noise the surrounding area such as residences, we recommend investigating the installation location and taking soundproofing measures.

# VRV S High Seasonal Efficiency SERIES

The Ideal Air Conditioning System for Residential Houses, Small Offices and Shops

Heat Pump  
**4 class – 8 class**  
(11.2 kW) (22.4 kW)



Presentation Movie



**New** RSUYQ4-6A2VMA  
 RSUYQ7-8AYM

## The VRV S High Seasonal Efficiency Series concept

New VRV S High Seasonal Efficiency Series achieves higher energy efficiency with a variety of function for comfort and high performance. A wide range of options for installation location and application are easily achieved by the low height casing, long piping length and other features.

Energy savings & comfort

High performance & reliability

Design flexibility of installation

### Energy savings & comfort

- ✓ Higher energy efficiency
- ✓ VRT Smart Control
- ✓ Quiet operation

### High performance & reliability

- ✓ Extended operation range up to 52°C
- ✓ High voltage shield PCB
- ✓ Automatic refrigerant charge function

### Design flexibility of installation

- ✓ The high external static pressure of 40 Pa enables installation in small installation spaces where the airflow direction needs to be diverted to avoid short circuits.
- ✓ Low height casing design
- ✓ Increased actual piping length up to 120 m



# Energy Savings & Comfort

## Energy savings

### High seasonal efficiency

The VRT Smart Control enables improvements on efficiency during low load operation, achieving high seasonal efficiency.

EER for 5 class

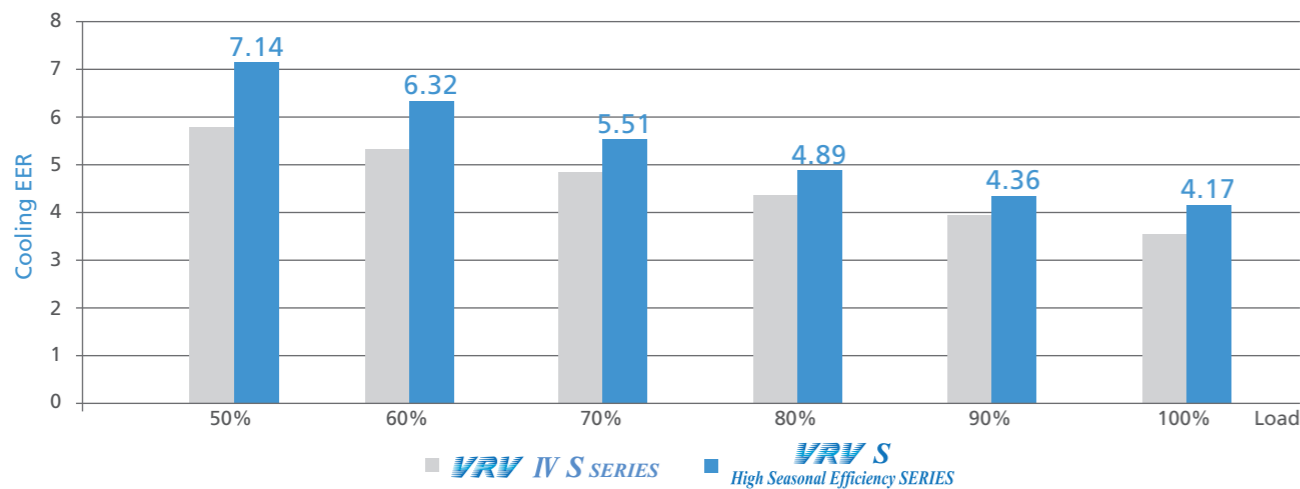

### VRT Smart Control

VRT Smart function is available in the VRV S High Seasonal Efficiency Series for the first time. Coordination between indoor and outdoor units minimizes energy consumption by optimizing capacity to meet actual operation load.

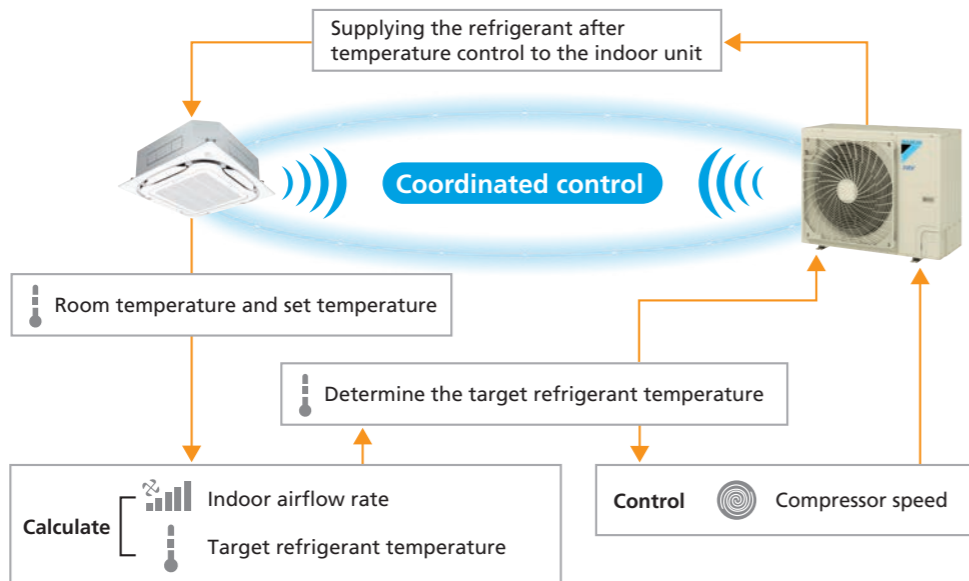

Notes: • For the classification of indoor units (VRT smart control and VRT control), refer to the indoor unit lineup.  
 • If a system has indoor units subject to both VRT smart and VRT control, the system is operated under VRT control.  
 • If a system has both outdoor-air processing air conditioners (FXMQ-MF series) and outdoor-air processing type indoor units, VRT smart control and VRT control are disabled.

## Comfort

### Quiet operation

#### V-cut & irregular pitch propeller fan

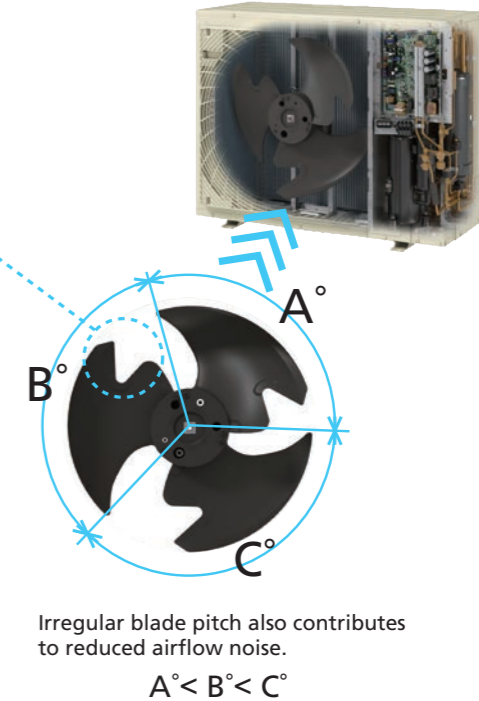
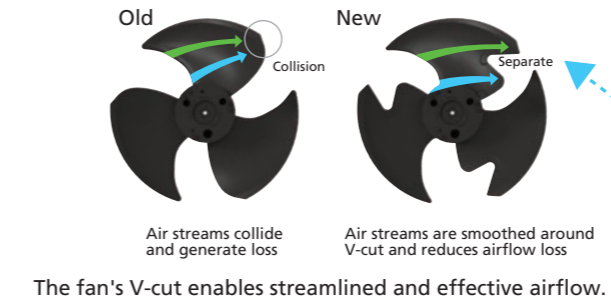

#### Nighttime quiet operation function

The nighttime quiet operation function automatically suppresses the nighttime operating sound by reducing operation capacity to maintain the quiet environment of the neighborhood. Three selectable modes are available depending on the required level. This function is suitable for use in residential areas.

Cooling	Night Quiet Mode
RSUYQ4/5/6A2	Min. 40 dB(A)
RSUYQ7/8A	Min. 45 dB(A)

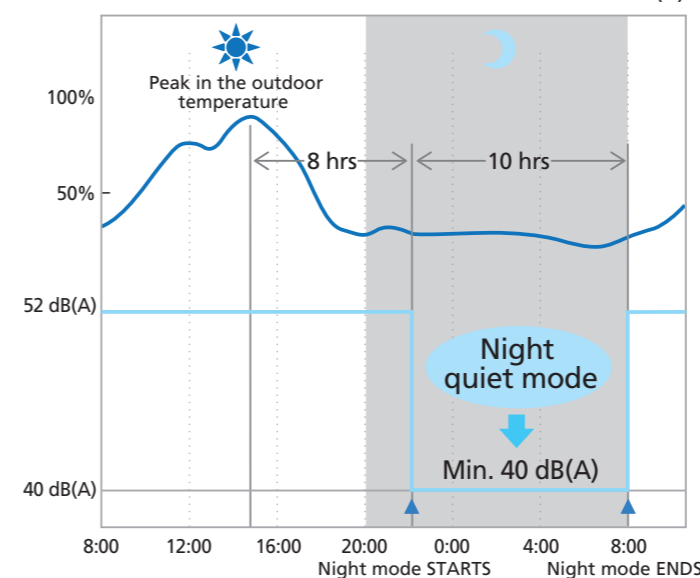

Notes: • This function is available in setting at site.  
 • The operating sound in quiet operation mode is the actual value measured by our company.  
 • The relationship of outdoor temperature (load) and time shown above is just an example.  
 • In case of 4-6 class outdoor unit

# High Performance & Reliability

## High temperature operation

### Extended operation range up to 52°C

The outdoor operation temperature range is now extended to 52°C. This enables reliable operation even under high temperature conditions and a wider choice of installation locations.

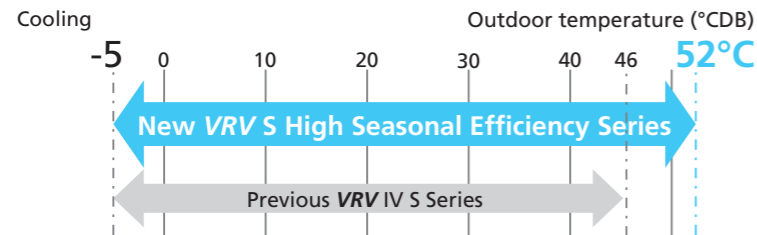

The refrigerant-cooled PCB and large 3-row heat exchanger raise the maximum cooling outdoor operation temperature from 46°C to 52°C.

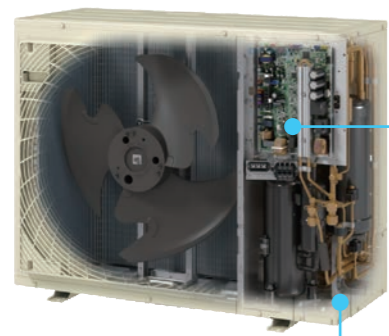

#### Refrigerant cooled PCB

Daikin's unique refrigerant cooling helps maintain high cooling capacity even during high outdoor temperatures.



#### New heat exchanger

- 2-sided 3-row
- Heat exchanger area **68%UP** (4,5 class model only)

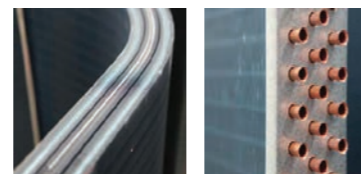
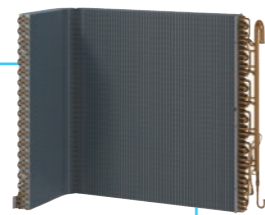

### Keep rated cooling capacity in high outdoor temperature up to 43°C

Rated cooling capacity can be maintained even when outdoor temperature is up to 43°C.

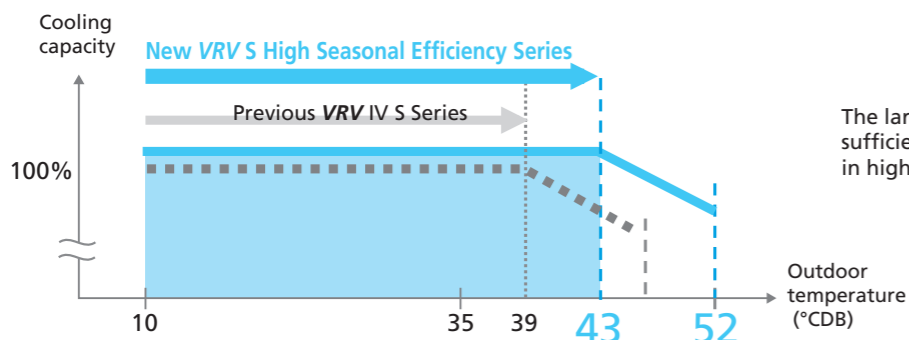

The large heat exchanger ensures sufficient cooling capacity even in high ambient temperatures.

## New swing compressor

### High efficiency, high capacity DC inverter swing compressor

The new compressors offer higher performance compared to that of conventional scroll compressors.

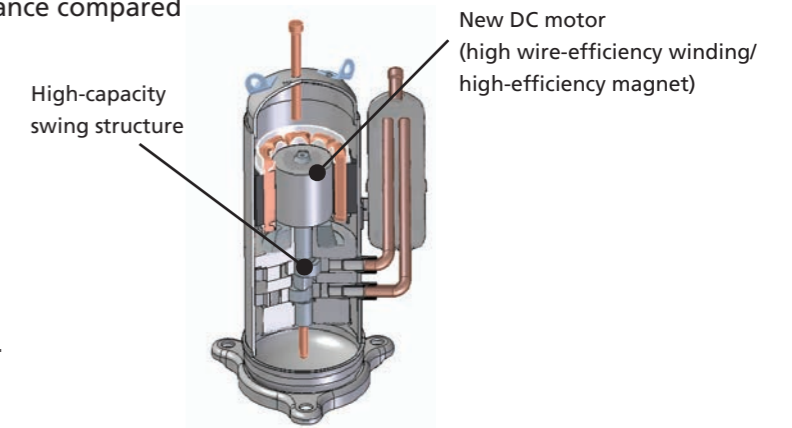

#### Improved performance

The new DC motor designed with small-diameter bearing and improved efficiency during low-speed operation has improved seasonal efficiency.

## High voltage shield PCB (4-6 class model only)

The high voltage shield PCB protects the electrical parts and prevents malfunctions at the highest voltage of 440 V.

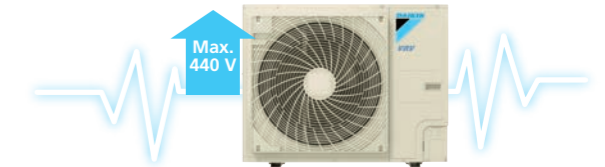

\* Continuous operation range is 198 to 264 V.

## Automatic refrigerant charge function

Contribute to optimised operation efficiency, higher quality and easier installation.

### Optimised operation efficiency

This function prevents a capacity shortage or energy loss due to excessive or insufficient refrigerant.

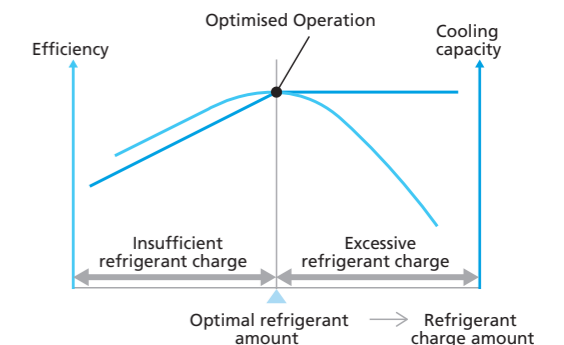

### Higher quality and easier installation

The automatic refrigerant charge function automates the charging of the proper refrigerant amount and easy start by pressing one button.

1 Calculation of necessary refrigerant amount from design drawing

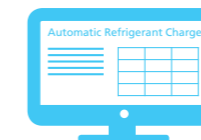

2 Start of automatic refrigerant charge operation



- Automatic completion by proper refrigerant amount
- Monitoring refrigerant charging is unnecessary
- No recalculation of charge amounts due to minor design changes locally

\*If pipe length exceeds 90 m, must use automatic refrigerant charge function. Refer to installation manual for details.



# Design Flexibility of Installation

## No short circuits

### High external static pressure up to 40 Pa and automatic adjustment of external static pressure

The new VRV S High Seasonal Efficiency Series outdoor unit has been achieved high external static pressure up to 40 Pa, realizing stable operation in small installation sites where the air direction adjustment grille or duct is used to avoid short circuits.

The external static pressure automatic adjustment function maintains rated airflow and capacity by automatically adjusting the external static pressure during the test operation to suit the resistance of the installation site.

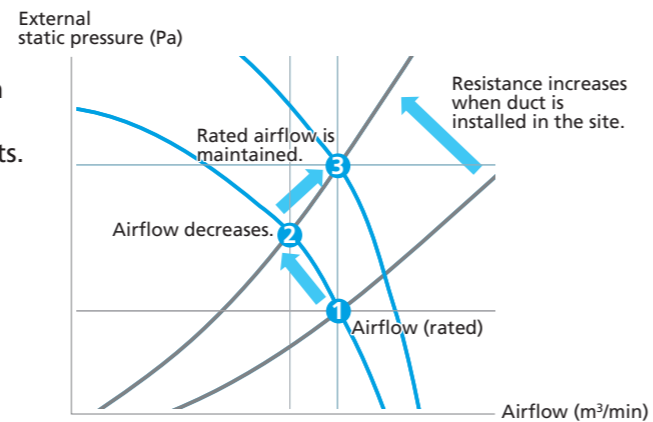

### Optimum airflow direction with the optional air direction adjustment grille

When discharged air is blocked by some obstacle, the optional air direction adjustment grille can divert the airflow to one of 4 directions (up, down, left or right) to avoid the obstacle.

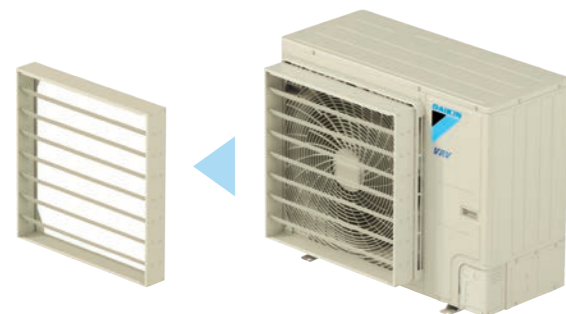

Air direction adjustment grille (option)

Wind is diverted upwards.

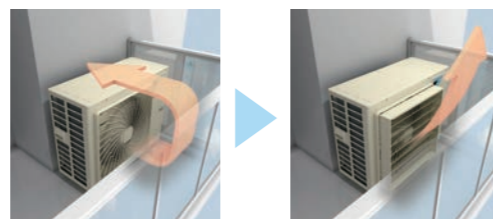

Wind is diverted sideways.

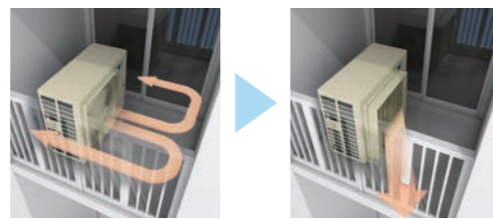

### Duct installation to stabilize the system

When the obstacle is not avoidable by the air direction adjustment grille, installing a field-supplied duct can bypass the obstacle. In this way, installation of the outdoor unit is possible in places like behind an advertising board.

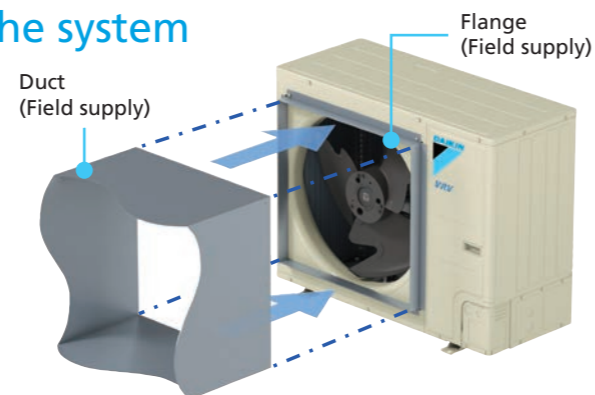

## Low height casing design

The new design has been optimised for the VRV S High Seasonal Efficiency Series with the height of all models reduced to only 870 mm. This low height casing design provides occupants with a clear, unobstructed view of the scenery.

Previous VRV IV S series

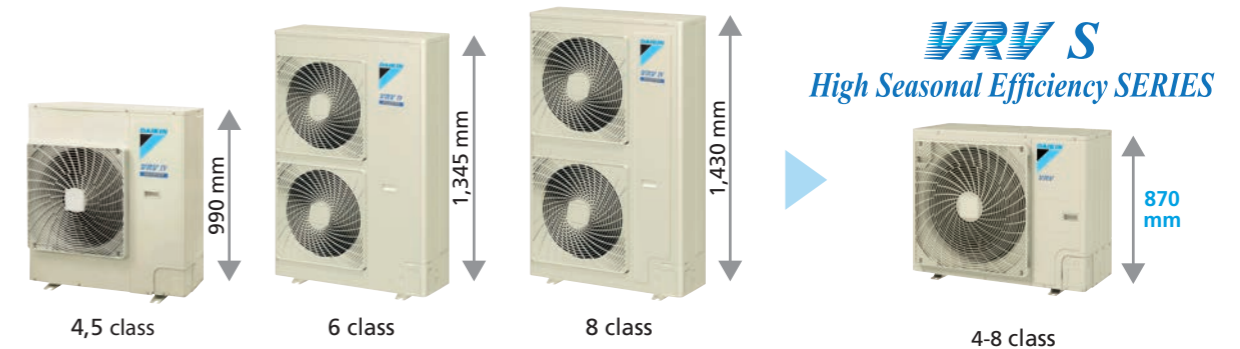

- Ideal solution that minimises both visual and sound impact
- Can be installed in a wide variety of locations and applications
- No space required for multiple outdoor units

View from outside



View from inside

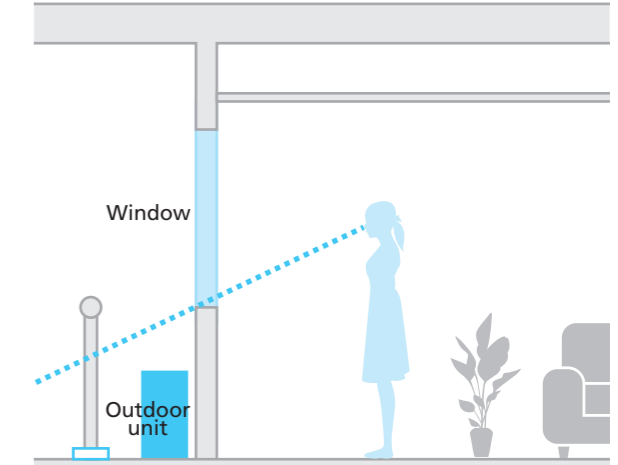

### Double-stacking installation possible

The low height casing design allows for compact double-stacking of outdoor units to maximize utilization of installation space.

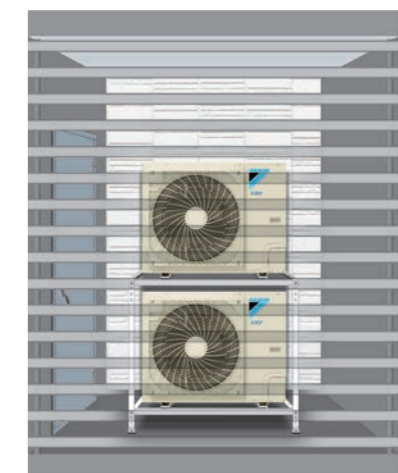

# Design Flexibility of Installation

## Increased actual piping length up to 120 m\*

Actual piping length increased by 20% allows for various installation!

Installation on the rooftop of residential apartments

Previous VRV IV S series **100 m** **▶** **120 m\***  
**VRV S High Seasonal Efficiency SERIES**

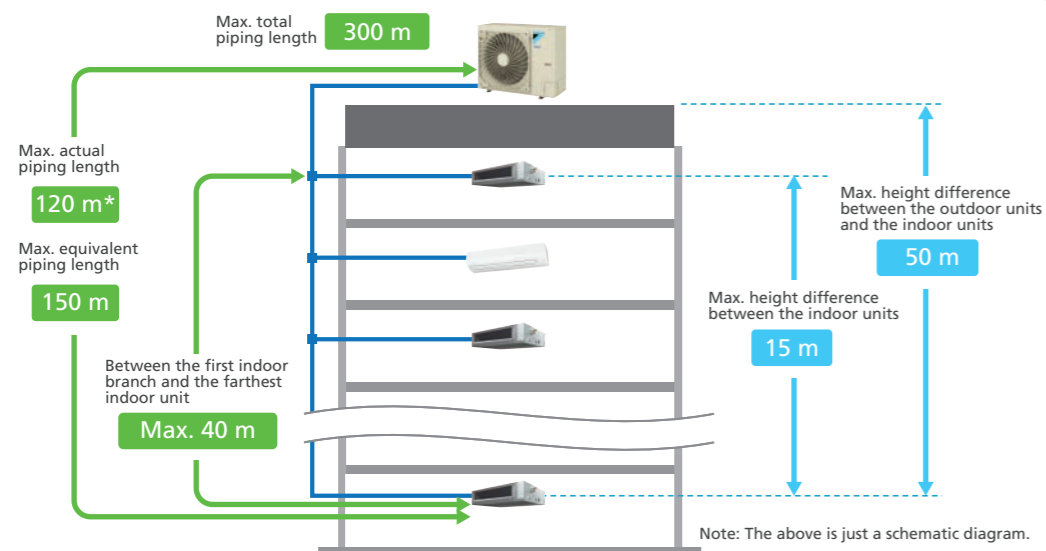

	4 class	5-8 class	
<b>Maximum allowable piping length</b>	Actual piping length (Equivalent)	120 m* (150 m)	120 m* (150 m)
	Total piping length	300 m	300 m
	Between the first indoor branch and the farthest indoor unit	40 m	40 m
<b>Maximum allowable height difference</b>	Between the indoor units	10 m	15 m
	Between the outdoor units and the indoor units	If the outdoor unit is above. 50 m If the outdoor unit is below. 40 m	50 m 40 m

\* If pipe length exceeds 90 m, must use automatic refrigerant charge function. Refer to installation manual for details.

Installation on balconies of residential apartments



One outdoor unit can provide comfort for the whole house



# Indoor Unit Lineup

## Wide variety of indoor unit

● New lineup ● Indoor units subject to VRT smart control

Category	Type	Model Name	Capacity Range(kW)	20	25	32	40	50	63	71	80	100	125	140	145	160	180	200	250	
				Capacity Index	20	25	31.25	40	50	62.5	71	80	100	125	140	145	160	180	200	250
Ceiling Mounted Cassette	Round Flow Cassette with Sensing and Streamer	New FXFTQ-AVM		●	●	●	●	●			●	●	●	●						
	Round Flow Cassette with Sensing	FXFSQ-AVM		●	●	●	●	●			●	●	●	●						
	Round Flow Cassette	FXFQ-AVM		●	●	●	●	●			●	●	●	●						
	Compact Multi Flow Cassette	New FXZQ-BVM		●	●	●	●	●												
	Double Flow Cassette	New FXCQ-BVM		●	●	●	●	●	●		●		●							
Ceiling Concealed Duct	Slim Duct (Standard)	FXDQ-PDVE		●	●	●														
		FXDQ-NDVE					●	●	●											
	Slim Duct (Compact)	FXDQ-TV1C(A)		●	●	●	●	●												
	Middle Static Pressure Duct	FXSQ-PAVE		●	●	●	●	●				●	●	●	●					
		FXDYQ-MAV1										●	●	●	●		●			
	Middle-High Static Pressure Duct	FXMQ-PAVE		●	●	●	●	●				●	●	●	●					
	High Static Pressure Duct	FXMQ-PV1A															●	●	●	
	Outdoor-Air Processing Unit	FXMQ-MFV1																	●	●
		New FXMQ-AFVM																	●	●
	Ceiling Suspended	4-Way Flow Ceiling Suspended	FXUQ-AVEB									●		●						
FXHQ-MAVE												●	●							
Ceiling Suspended		New FXHQ-BVM												●	●					
Wall Mounted	FXAQ-AVM		●	●	●	●	●	●												
	Floor Standing	FXLQ-MAVE		●	●	●	●	●												
Concealed Floor Standing		FXNQ-MAVE		●	●	●	●	●												
Heat Reclaim Ventilator	VAM-HVE		Airflow rate 150-2000 m³/h																	

Note: For indoor units without 'VRT Smart', the standard 'VRT' control is available (excludes Heat Reclaim Ventilators).

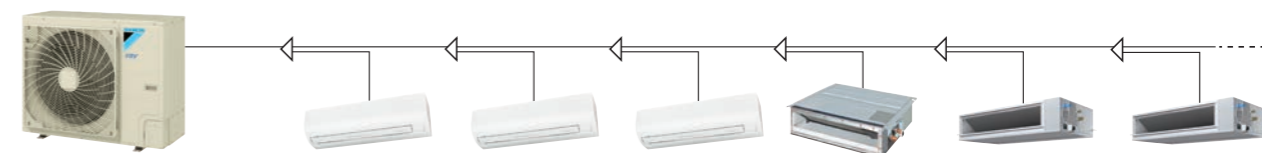

Max. 13 indoor units

- If a system has indoor units subject to both VRT smart and VRT control, the system is operated under VRT control.
- If a system has both outdoor-air processing air conditioners (FXMQ-MF series) and outdoor-air processing type indoor units, VRT smart control and VRT control are disabled.



# Outdoor Units

## VRV S High Seasonal Efficiency Series

### Specifications

Heat Pump



MODEL		RSUYQ4A2VMA	RSUYQ5A2VMA	RSUYQ6A2VMA	RSUYQ7AYM	RSUYQ8AYM	
Power supply		1-phase, 220-240/220-230 V, 50/60 Hz			3-phase, 380-415 V/380 V, 50/60 Hz		
Cooling capacity	Btu/h	38,200	47,800	54,600	68,200	76,400	
	kW	11.2	14.0	16.0	20.0	22.4	
Heating capacity	Btu/h	42,700	54,600	61,400	76,400	85,300	
	kW	12.5	16.0	18.0	22.4	25.0	
Power consumption	Cooling	kW	2.48	3.36	3.95	5.46	6.61
	Heating	kW	2.51	3.28	3.90	5.10	5.92
Capacity control	%	23 to 100	15 to 100		9 to 100		
AEER*	Cooling	4.07	3.81	3.73	3.42	3.19	
ACOP*	Heating	4.46	4.42	4.22	4.09	3.95	
TCSPP* (Cooling) Commercial / Residential	Hot	5.85 / 5.29	6.04 / 5.45	6.10 / 5.51	5.34 / 4.87	5.18 / 4.71	
	Average	5.57 / 4.21	5.91 / 4.47	6.04 / 4.60	5.30 / 4.13	5.19 / 4.06	
	Cold	5.78 / 4.09	6.23 / 4.45	6.39 / 4.63	5.60 / 4.15	5.53 / 4.14	
HSPF* (Heating) Commercial / Residential	Hot	4.96 / 4.98	4.69 / 4.71	4.37 / 4.39	5.00 / 5.00	4.83 / 4.82	
	Average	4.81 / 4.74	4.55 / 4.50	4.25 / 4.22	4.74 / 4.58	4.58 / 4.41	
	Cold	4.56 / 4.47	4.28 / 4.18	4.02 / 3.95	4.42 / 4.22	4.27 / 4.07	
Casing colour		Ivory white (5Y7.5/1)					
Compressor	Type	Hermetically sealed swing type					
	Motor output (Cooling / Heating)	kW	2.0/2.4	3.1/3.6	3.5/4.0	1.9/2.3	3.2/3.2
Airflow rate	Cooling	ℓ/s	1,450	1,400	1,450	2,050	
		m³/min	87	84	87	123	
	Heating	ℓ/s	1,500	1,400	1,567	2,283	2,417
		m³/min	90	84	94	137	145
Dimensions (HxWxD)	mm	870x1,100x460					
Machine weight	kg	95	98		120		
Sound pressure level (Cooling/Heating)	dB(A)	52/54	53/54	55/56	58/61	59/63	
Sound power level (Cooling/Heating)	dB(A)	73/75	74/75	76/77	79/82	80/84	
Operation range	Cooling	°CDB					
	Heating	°CWB					
Refrigerant	Type	R-410A					
	Charge	kg	4.0	4.2		5.4	
Piping connections	Liquid	mm					
	Gas	mm		mm		mm	
		φ 15.9 (Flare)		φ 9.5 (Flare)		φ 19.1 (Brazing)	

Note: 1. Specifications are based on the following conditions;

- Cooling: Indoor temp.: 27°CDB, 19°CWB, Outdoor temp.: 35°CDB, Equivalent piping length: 7.5 m, Height difference: 0 m.
  - Heating: Indoor temp.: 20°CDB, Outdoor temp.: 7°CDB, 6°CWB, Equivalent piping length: 7.5 m, Height difference: 0 m.
  - Sound level: Anechoic chamber conversion value, measured at a point 1 m in front of the unit at a height of 1.5 m.
- During actual operation, these values are normally somewhat higher as a result of ambient conditions and oil recovery mode.
- When there is concern for noise the surrounding area such as residences, we recommend investigating the installation location and taking soundproofing measures.
- Refrigerant charge is required.

★ Values based on GEMS determination 2019.

**TCSPP: Total Cooling Seasonal Performance Factor**  
**HSPF: Heating Seasonal Performance Factor**

In simple terms, TCSPP & HSPF represents the ratio of the Total Cooling & Heating capacity of the air-conditioner relative to the Total energy consumed by the air-conditioner during the Total Cooling & Heating operation periods in a year.

Whereas the previous index of AEER & ACOP was calculated using only one representative outdoor temperature (35°C for cooling and 7°C for heating), the new index of TCSPP & HSPF uses a broader range of annual outdoor temperatures\* as stipulated in AS/NZS 3823.4.1:2014.

Further, the annual outdoor temperatures are based on zoning Australia/ New Zealand into three distinct climate zones (Hot/Average/Cold).

This allows you to determine the performance efficiency of different air-conditioners by comparing their TCSPP & HSPF within the same climate zone.

\* There are two kinds of annual outdoor temperatures and it's different for residential and commercial use.

### Outdoor unit combinations

MODEL		RSUYQ5A2VMA	RSUYQ4A2VMA	RSUYQ6A2VMA	RSUYQ7AYM	RSUYQ8AYM	
kW		11.2	14.0	16.0	20.0	22.4	
Class		4	5	6	7	8	
Capacity index		100	125	150	175	200	
Total capacity index of connectable indoor units	Combination(%)	50%	50	62.5	75	87.5	100
		100%	100	125	150	175	200
		130%	130	162.5	195	227.5	260
Maximum number of connectable indoor units		6	8	9	11	13	

Note: Total capacity index of connectable indoor units must be 50%-130% of the capacity index of the outdoor unit.

# VRV IV S SERIES

The Ideal Air Conditioning System for Residential Houses, Small Offices and Shops

Heat Pump  
3.5 class — 9 class  
(9 kW) (24 kW)



**New** RXYMQ3-4A2V4A  
**New** RXYMQ5-6B2VM  
RXYMQ8-9AY1

## Compact & lightweight design

The VRV IV S series is slim and compact, with outdoor units that require minimal installation space.

3.5 class — 6 class



8 class / 9 class



	3.5 class / 4 class	5 class	6 class	8 class / 9 class
Height	990 mm	990 mm	990 mm	1,430 mm
Product Weight	71 kg	78 kg	80 kg	138 kg
Footprint	0.30 m <sup>2</sup>	0.30 m <sup>2</sup>	0.30 m <sup>2</sup>	0.30 m <sup>2</sup>

## Energy saving

### High Energy Efficiency Ratio (EER)

VRV IV S series provides greater energy saving as compared to VRV III S series.

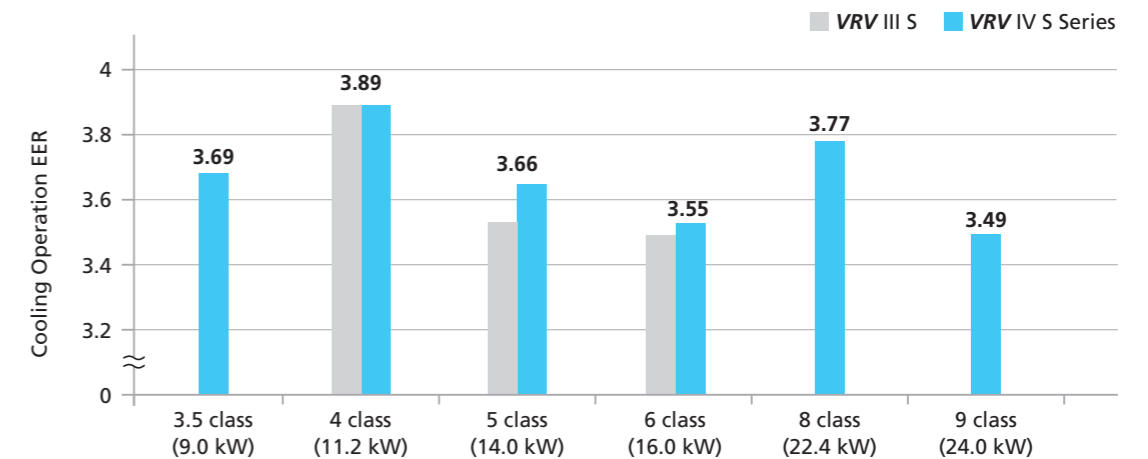

\*Cooling operation conditions: Indoor temp. of 27° CDB, 19° CWB, and outdoor temp. of 35° CDB.



# Comfort and Simplified Installation

## Quiet operation

### Nighttime quiet operation function

The nighttime quiet operation function automatically suppresses the nighttime operating sound by reducing operation capacity to maintain the quiet environment of the neighborhood. Three selectable modes are available depending on the required level. This function is suitable for use in residential areas.

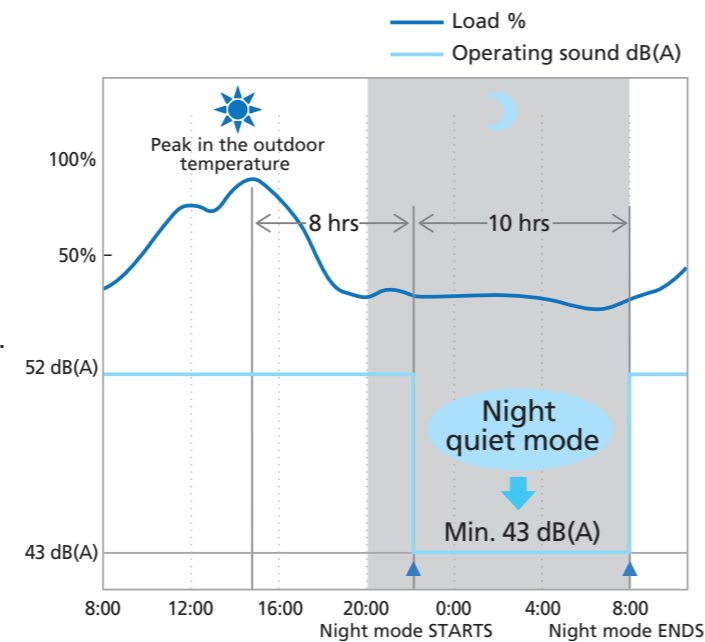

- Notes:
- This function is available in setting at site.
  - The operating sound in quiet operation mode is the actual value measured by our company.
  - The relationship of outdoor temperature (load) and time shown above is just an example.
  - In case of 4 class outdoor unit

## Makes the long piping design possible

Long piping length offers flexibility in the choice of installation positions, and simplifies system planning.

- Actual piping length **Max. 100 m**
- Equivalent piping length **Max. 130 m**
- Total piping length **Max. 300 m**

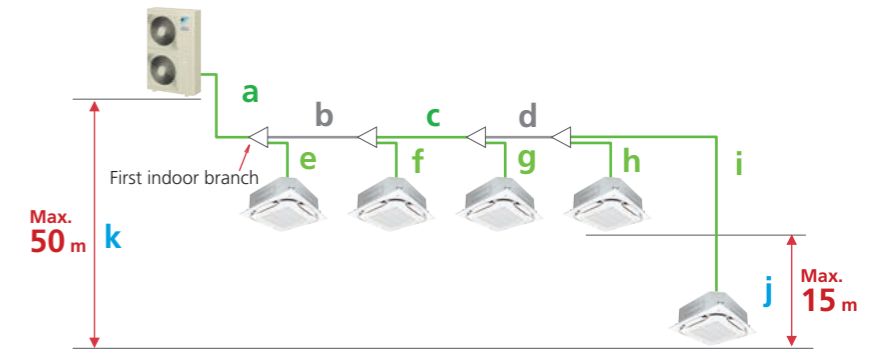

		3,5,4 class	5,6 class	8,9 class		
Max. allowable piping length	Actual refrigerant piping length (Equivalent)	a+b+c+d+i	70 m (90 m)	70 m (90 m)	100 m (130 m)	
	Total piping length	a+b+c+d+e+f+g+h+i	250 m	300 m	300 m	
	Between the first indoor branch and the farthest indoor unit	b+c+d+i	40 m	40 m	40 m	
Max. allowable height difference	Between the indoor units	j	10 m	15 m	15 m	
	Between the outdoor unit and the indoor unit	If the outdoor unit is above	k	30 m	30 m	50 m
		If the outdoor unit is below	k	30 m	30 m	40 m

## Technologies for efficient and quiet operation

### Swing compressor (3.5-6 class model only)

Daikin swing compressor has integrated the rotor with the blade, completely solving the refrigerant leakage and the wear problem caused by the mechanical friction between the rotor and the blade, which enhances the compressor efficiency and makes the compressor more quiet and durable.

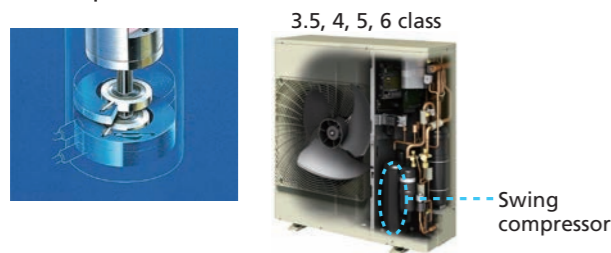

### The structural scroll (8-9 class model only)

Sucked gas is compressed in the scrolling part before the heated motor, so that the machine compresses the non-expanded gas, resulting in high efficiency compression.

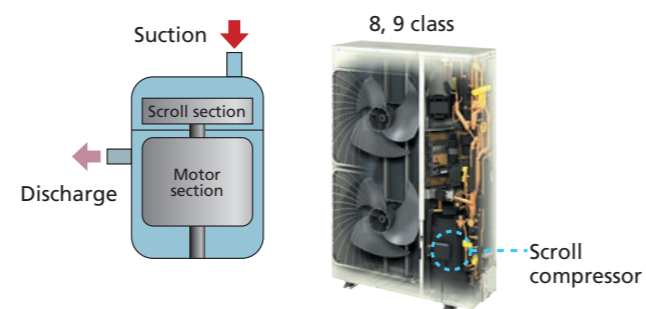

### Smooth air inlet bell mouth and aero spiral fan

The smooth air inlet bell mouth and the aero spiral fan work to minimize turbulence in the airflow and reduce sound.

### DC fan motor

Efficiency improved in all areas compared to conventional AC motors, especially at low speeds.

# Indoor Unit Lineup

## Enhanced range of choices

● New lineup

Category	Type	Model Name	Capacity Range (kW)	Capacity Index																			
				20	25	32	40	50	63	71	80	100	125	140	145	160	180	200	250				
				2.2	2.8	3.6	4.5	5.6	7.1	8	9	11.2	14	16	16.2	18	20	22.4	28				
Ceiling Mounted Cassette	Round Flow Cassette with Sensing and Streamer	<b>FXFTQ-AVM</b>			●	●	●	●	●		●	●	●	●									
	Round Flow Cassette with Sensing	FXFSQ-AVM			●	●	●	●	●		●	●	●	●									
	Round Flow Cassette	FXFQ-AVM			●	●	●	●	●		●	●	●	●									
	Compact Multi Flow Cassette	<b>FXZQ-BVM</b>		●	●	●	●	●															
	Double Flow Cassette	<b>FXCQ-BVM</b>		●	●	●	●	●	●		●	●											
	Single Flow Cassette	FXEQ-AV36		●	●	●	●	●	●														
Ceiling Concealed Duct	Slim Duct (Standard)	FXDQ-PDVE		●	●	●																	
		FXDQ-NDVE					●	●	●														
	Slim Duct (Compact)	FXDQ-TV1C(A)		●	●	●	●	●	●														
	Middle Static Pressure Duct	FXSQ-PAVE		●	●	●	●	●	●		●	●	●	●									
		FXDYQ-MAV1									●	●	●	●	●								
	Middle-High Static Pressure Duct	FXMQ-PAVE		●	●	●	●	●	●		●	●	●	●									
	High Static Pressure Duct	FXMQ-PV1A													●	●	●	●					
	Outdoor-Air Processing Unit	FXMQ-MFV1											●					●					
		<b>FXMQ-AFVM</b>										●		●				●	●				
Ceiling Suspended	4-Way Flow Ceiling Suspended	FXUQ-AVEB								●		●											
	Ceiling Suspended	FXHQ-MAVE			●		●	●		●	●												
		<b>FXHQ-BVM</b>											●	●									
Wall Mounted	FXAQ-AVM		●	●	●	●	●	●															
Floor Standing	Floor Standing	FXLQ-MAVE		●	●	●	●	●	●														
	Concealed Floor Standing	FXNQ-MAVE		●	●	●	●	●	●														
Heat Reclaim Ventilator	VAM-HVE		Airflow rate 150-2000 m³/h																				

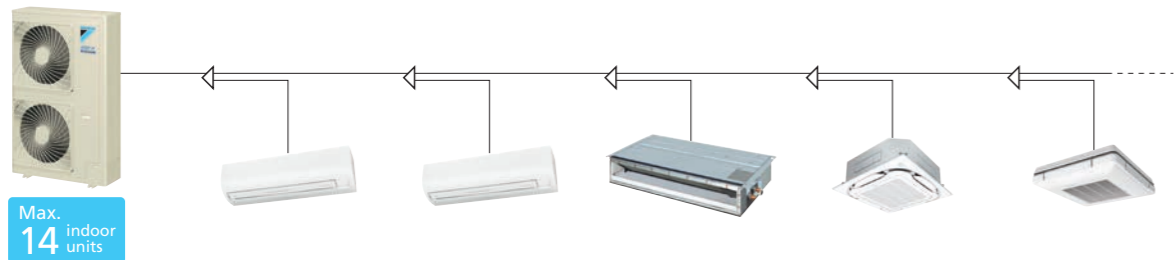

Max. 14 indoor units

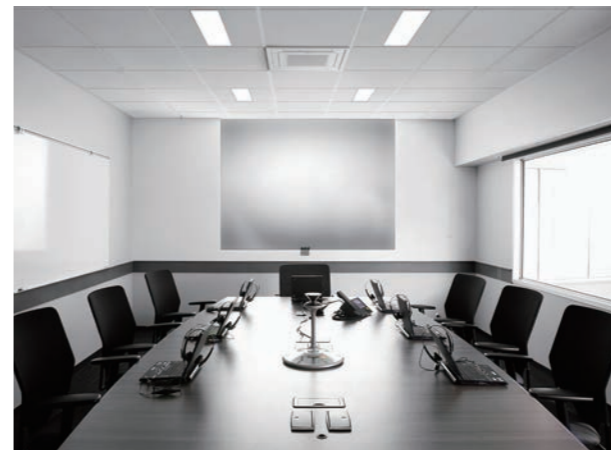



# Outdoor Units

## VRV IV S Series

### Specifications

Heat Pump

MODEL		RXYMQ3A2V4A	RXYMQ4A2V4A	RXYMQ5B2VM	RXYMQ6B2VM	RXYMQ8AY1	RXYMQ9AY1
Power supply		1-phase, 220-230 V, 50 Hz		1-phase, 220-240 V/220-230 V, 50/60 Hz		3-phase, 380-415 V, 50 Hz	
Cooling capacity	Btu/h	30,700	38,200	47,800	54,600	76,400	81,900
	kW	9.0	11.2	14.0	16.0	22.4	24.0
Heating capacity	Btu/h	34,100	42,700	47,800	54,600	85,300	88,700
	kW	10.0	12.5	14.0	16.0	25.0	26.0
Power consumption	Cooling	2.44	2.88	3.83	4.51	5.94	6.88
	Heating	2.28	2.60	3.04	3.59	6.25	6.82
Capacity control	%	24 to 100		15 to 100		20 to 100	
AEER*	Cooling	—	—	3.39	3.31	—	—
ACOP*	Heating	—	—	4.20	4.09	—	—
TCSPF* (Cooling) Commercial / Residential	Hot	—	—	5.38 / 4.87	5.16 / 4.70	—	—
	Average	—	—	5.29 / 4.02	5.11 / 3.97	—	—
	Cold	—	—	5.58 / 4.01	5.40 / 3.99	—	—
HSPF* (Heating) Commercial / Residential	Hot	—	—	4.33 / 4.35	4.28 / 4.30	—	—
	Average	—	—	4.20 / 4.16	4.14 / 4.08	—	—
	Cold	—	—	3.91 / 3.80	3.84 / 3.71	—	—
Casing colour	Ivory white (5Y7.5/1)						
Compressor	Type	Hermetically sealed swing type				Hermetically sealed scroll type	
	Motor output (Cooling/Heating) kW	1.92	3.2/3.5	3.7	3.8	4.8	
Airflow rate	ℓ/s	1,267	1,350	1,333	2,333		
	m³/min	76	81	80	140		
Dimensions (HxWxD)	mm	990x940x320				1,430x940x320	
Machine weight	kg	71	78	80	138		
Sound level (Cooling/Heating)	dB(A)	51/52	52/54	53/54	55/56	57/58	58/59
Sound power	dB(A)	69	70	74	76	75	76
Operation range	Cooling	°CDB -5 to 46					
	Heating	°CWB -20 to 15.5					
Refrigerant	Type	R-410A					
	Charge	kg	2.9	3.4	4.0	5.8	
Piping connections	Liquid	φ 9.5 (Flare)				φ 9.5 (Brazing)	
	Gas	φ 15.9 (Flare)		φ 19.1 (Brazing)		φ 22.2 (Brazing)	

Notes: Specifications are based on the following conditions;

- Cooling: Indoor temp.: 27° CDB, 19° CWB, Outdoor temp.: 35° CDB, Equivalent piping length: 7.5 m, Height difference: 0 m.
- Heating: Indoor temp.: 20° CDB, Outdoor temp.: 7° CDB, 6° CWB, Equivalent piping length: 7.5 m, Height difference: 0 m.
- Sound level: Anechoic chamber conversion value, measured at a point 1 m in front of the unit at a height of 1.5 m.
- During actual operation, these values are normally somewhat higher as a result of ambient conditions and oil recovery mode.
- When there is concern for noise the surrounding area such as residences, we recommend investigating the installation location and taking soundproofing measures.
- Refrigerant charge is required.

★ Values based on GEMS determination 2019.

**TCSPF: Total Cooling Seasonal Performance Factor**  
**HSPF: Heating Seasonal Performance Factor**  
 In simple terms, TCSPF & HSPF represents the ratio of the Total Cooling & Heating capacity of the air-conditioner relative to the Total energy consumed by the air-conditioner during the Total Cooling & Heating operation periods in a year.  
 Whereas the previous index of AEER & ACOP was calculated using only one representative outdoor temperature (35°C for cooling and 7°C for heating), the new index of TCSPF & HSPF uses a broader range of annual outdoor temperatures\* as stipulated in AS/NZS 3823.4.1:2014.  
 Further, the annual outdoor temperatures are based on zoning Australia/ New Zealand into three distinct climate zones (Hot/Average/Cold). This allows you to determine the performance efficiency of different air-conditioners by comparing their TCSPF & HSPF within the same climate zone.  
 \* There are two kinds of annual outdoor temperatures and it's different for residential and commercial use.

### Outdoor unit combinations

MODEL	RXYMQ3A2V4A	RXYMQ4A2V4A	RXYMQ5B2VM	RXYMQ6B2VM	RXYMQ8AY1	RXYMQ9AY1	
kW	9.0	11.2	14.0	16.0	22.4	24.0	
class	3.5	4	5	6	8	9	
Capacity index	80	100	125	150	200	215	
Total capacity index of connectable indoor units	Combination(%)	50%	40	50	62.5	75	100
		100%	80	100	125	150	200
		130%	104	130	162.5	195	260
Maximum number of connectable indoor units	5	6	8	9	13	14	

Note: Total capacity index of connectable indoor unit be 50%–130% of the capacity index of the outdoor unit.

# VRV IV Q SERIES

For Quick & High Quality Replacement Use

Heat Pump  
**6 class—48 class**  
(16 kW) (135 kW)



**Standard Type**

Single outdoor units  
**RQYQ6-16TY1A(E)**

Double outdoor units  
**RQYQ18-32TNY1A(E)**

Triple outdoor units  
**RQYQ34-48TNY1A(E)**

**Space Saving Type**

Single outdoor units  
**RQYQ18-20TY1A(E)**

Double outdoor units  
**RQYQ30-40TSY1A(E)**

Triple outdoor units  
**RQYQ42-48TSY1A(E)**

\* (E) : anti-corrosion model

# VRV III-Q



**RQCEQ280-848PY1**

Heat Recovery  
**10 class—30 class**  
(28 kW) (84.8 kW)

## The VRV IV Q Series concept

Reusing existing refrigerant piping minimizes installation time and cost

An automatic refrigerant charge function enables high quality installation

Improvement in capacity and greater number of indoor units

## Quick, quality and economical replacement

### Reuse

#### Simple use of existing refrigerant piping

Special equipment and work is no longer required to clean pipes. A new function automatically deals with contamination inside piping during refrigerant charging, eliminating the work involved in cleaning.

#### Even applicable for non-DAIKIN systems! The Daikin low-cost upgrade solution

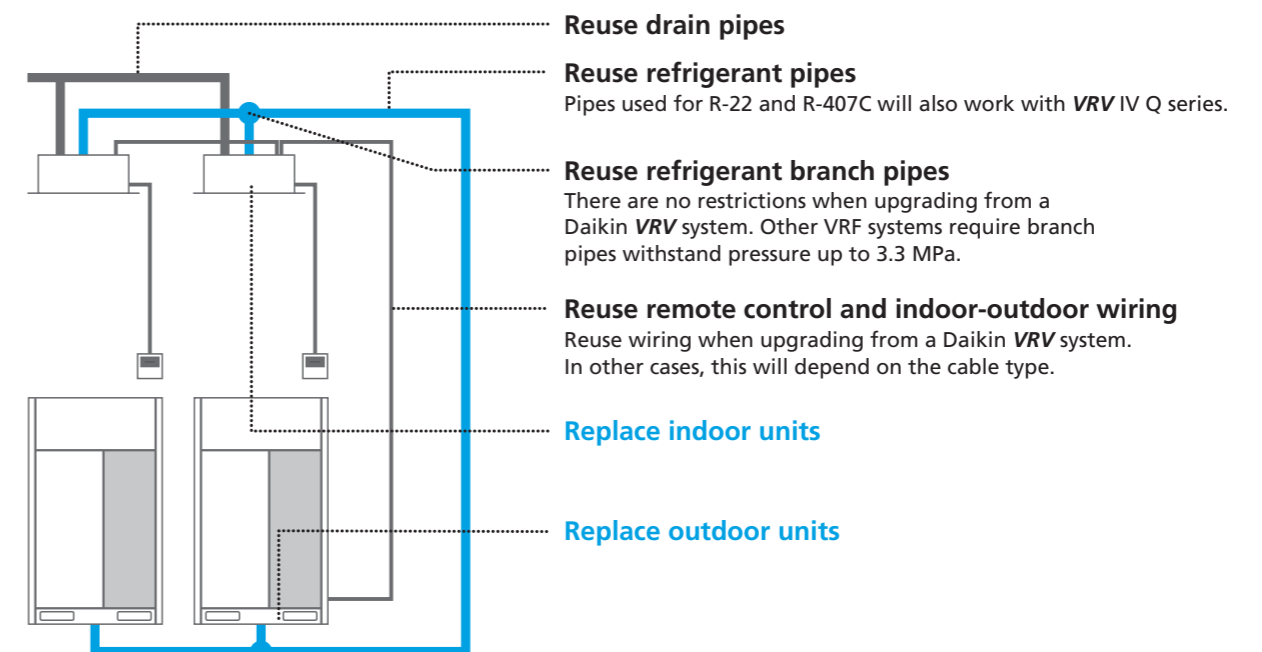



# Benefits of System Replacement

## Automatic

Refrigerant charging, cleaning and test operation done with just a single switch.

The automatic refrigerant charge function automates the charging of the proper refrigerant amount and the closing of shut-off valves by simply pressing a switch after pre-charging. Furthermore, there is no need to clean inside piping as this is handled automatically by the VRV IV Q unit.

\* There are conditions in the range (ambient temperature, connection ratio) in which the automatic refrigerant charge can be used. Refer to the installation manual for details. The refrigerant amount that can be automatically charged may differ from the additional refrigerant amount that is provided from calculations, but there are no problems in performance and quality.

## Time saving

Enables smooth replacement of air conditioning with less effect on operations and users in the building.

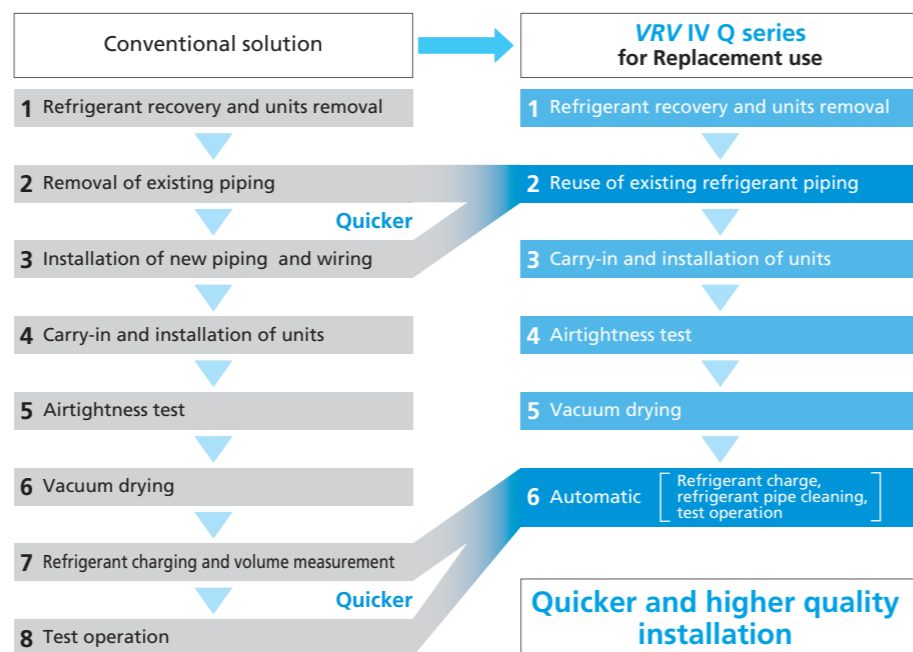

## Cost saving

By the reuse of existing piping, 35% of cost down can be realized compared to installing new pipes.

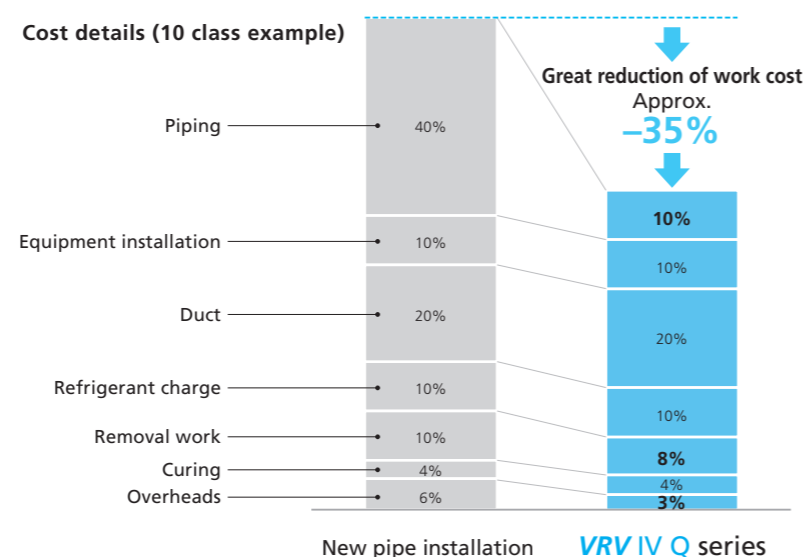

## Design flexibility

Significantly more compact outdoor unit enables the effective use of limited space!

Compact design enables the effective use of space taken up by existing machinery

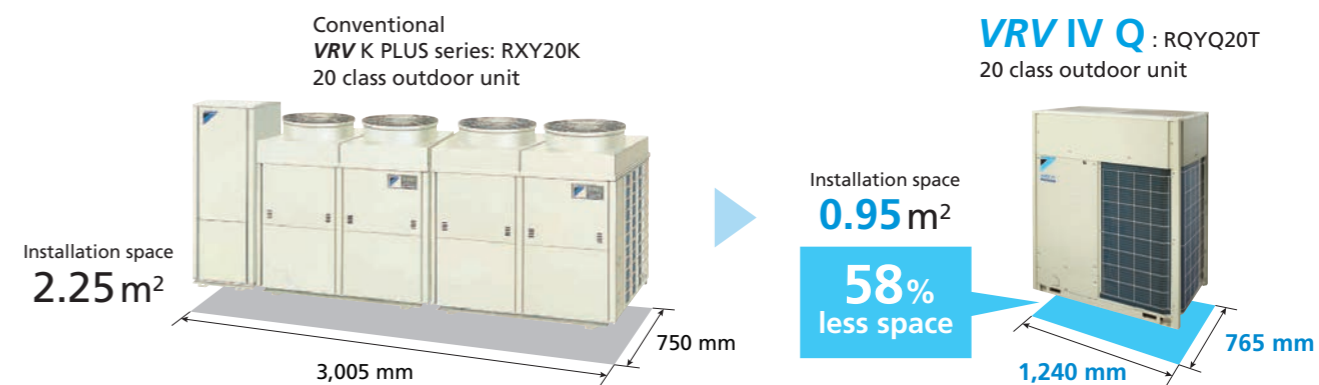

## High external static pressure 78.4 Pa

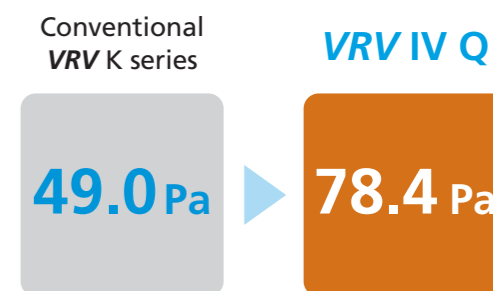

## System flexibility

An increased number of connectable indoor units in a single system

More indoor units can be connected in a single system, enabling consolidation of existing piping!

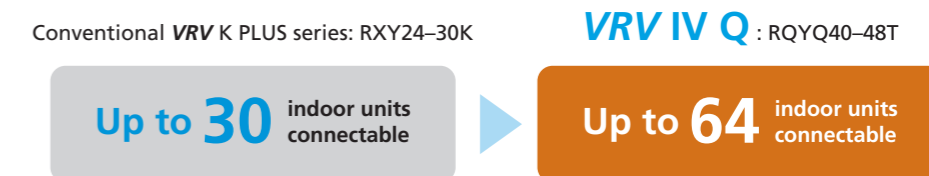

# Benefits of System Replacement

## Enables increased capacity

VRV IV Q series for replacement use enables the system capacity to be increased without changing the refrigerant piping. For example, it is possible to install a 16 class VRV IV Q series using the refrigerant piping of an 10 class R-22 system.

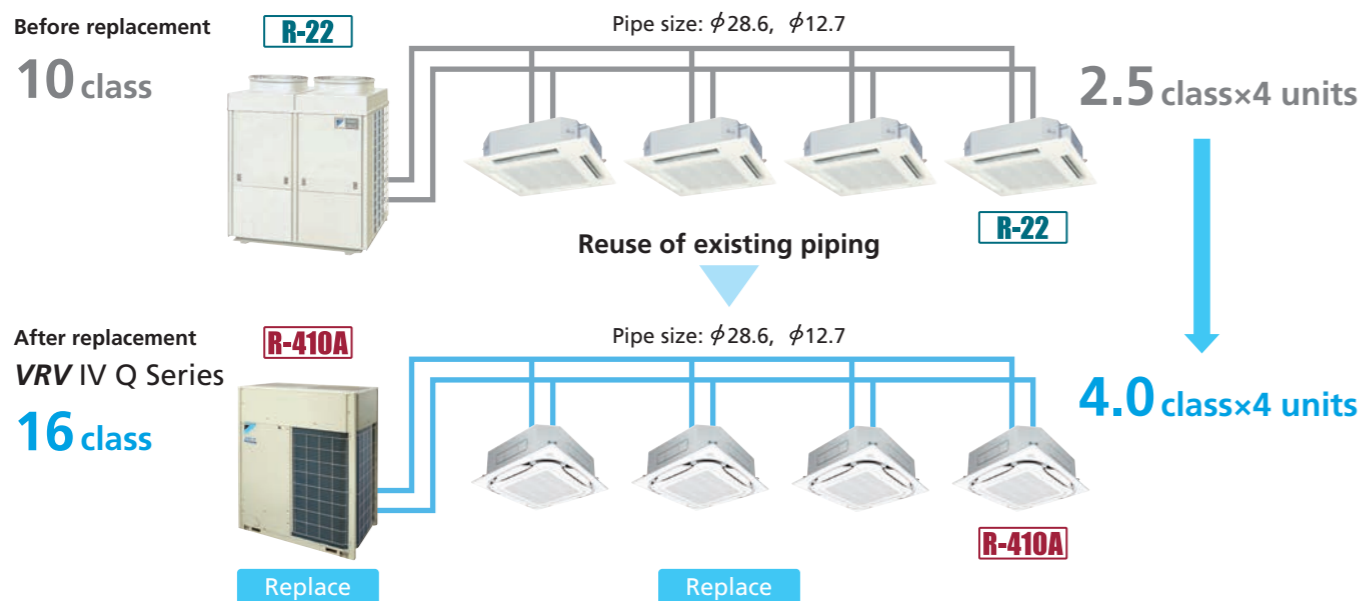

## Energy saving

### Higher Energy Efficiency Ratio (EER)

VRV IV Q series delivers highly efficient performance, contributing to high energy savings.

\* Cooling operation conditions: Indoor temp. of 27° CDB, 19° CWB, and outdoor temp. of 35° CDB.

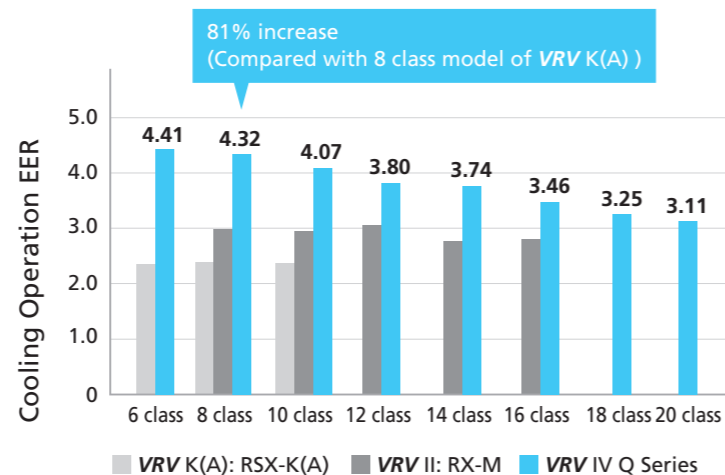

### VRT Control for optimal annual efficiency

VRT automatically adjusts refrigerant temperature to individual building and climate requirement, thus further improving annual energy efficiency and maintaining comfort.



## New technology that enables use of existing piping

### New tested contamination collection method

A new method collects contamination from existing piping, eliminating compressors and electric valves malfunction.

VRV IV Q series only

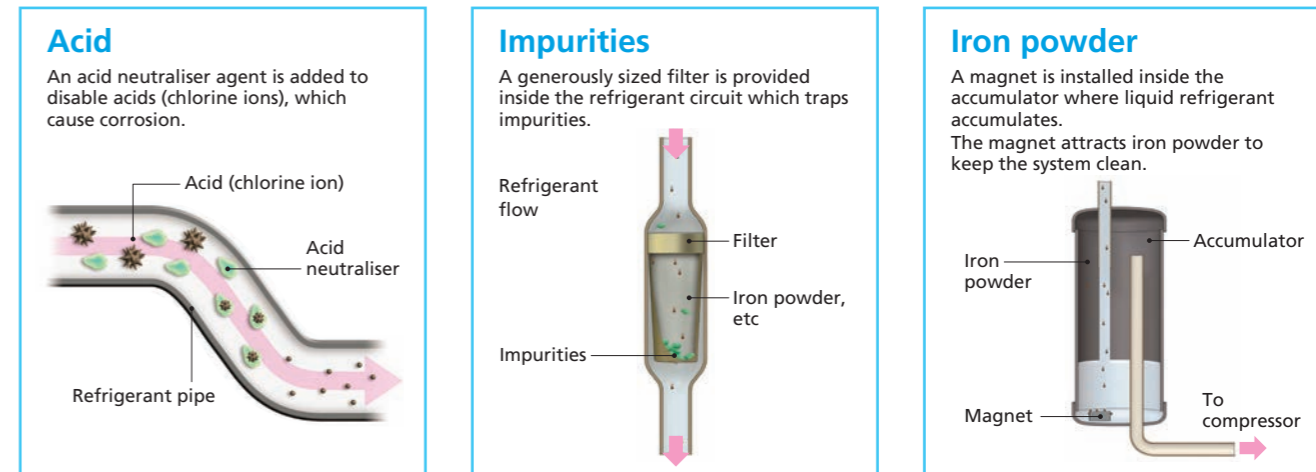

## Reliable and stable technology

### High reliability at high ambient temperatures

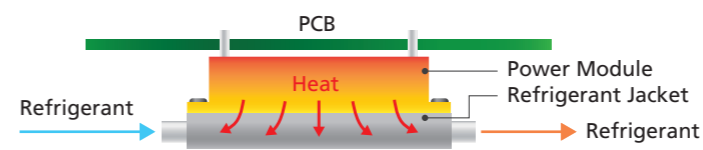

Using refrigerant to cool the inverter power module helps minimise the size of the electronic components, and this results in reduction of airflow resistance and high efficiency of the heat exchanger.

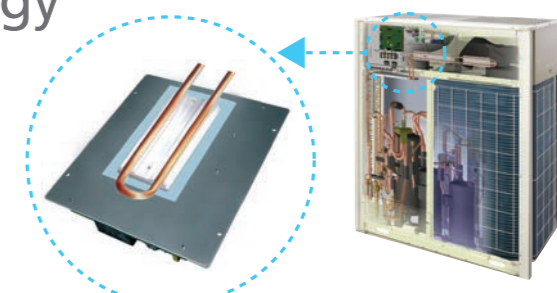

Control board failure ratio at stable operation is reduced.

This enables

- Suitability for high ambient temperatures
- Miniaturization of electronic components

### SMT\* packaging technology

- Improves the anti-clutter performance.
- Protects your computer boards from the adverse effects of sandy climates and humid weather.

\*SMT: Surface mounted technology

Computer control board surface adopting SMT packaging technology

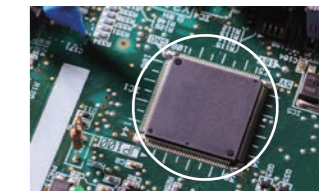
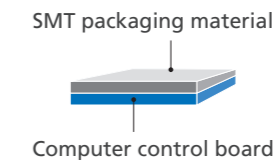

### Outer Rotor DC Motor (ODM)

Only Daikin has adapted an ODM with the feature of stable rotation and volumetric efficiency.

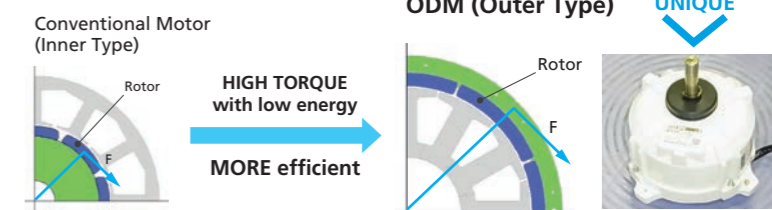



# Guidelines for Reuse of Existing Refrigerant Piping

## Piping limits for reuse of existing piping

### VRV IV Q Series Heat Pump

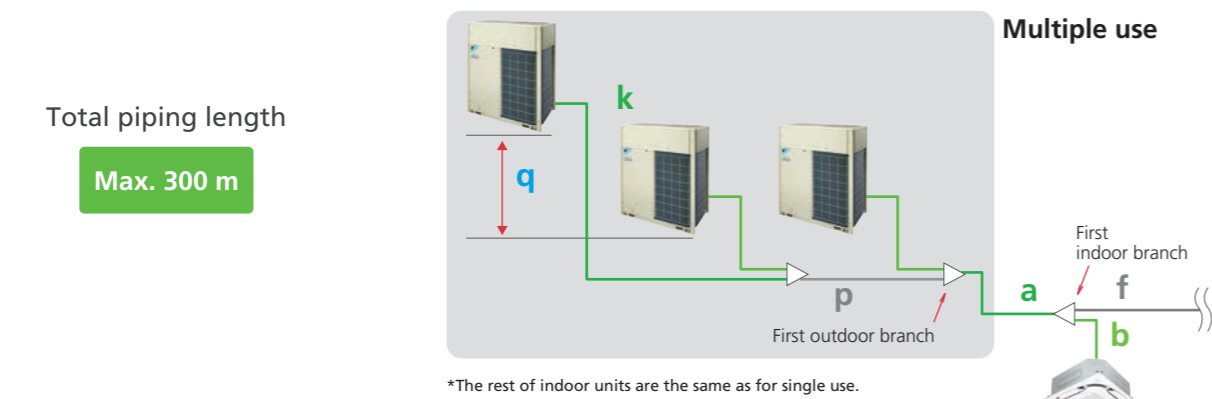
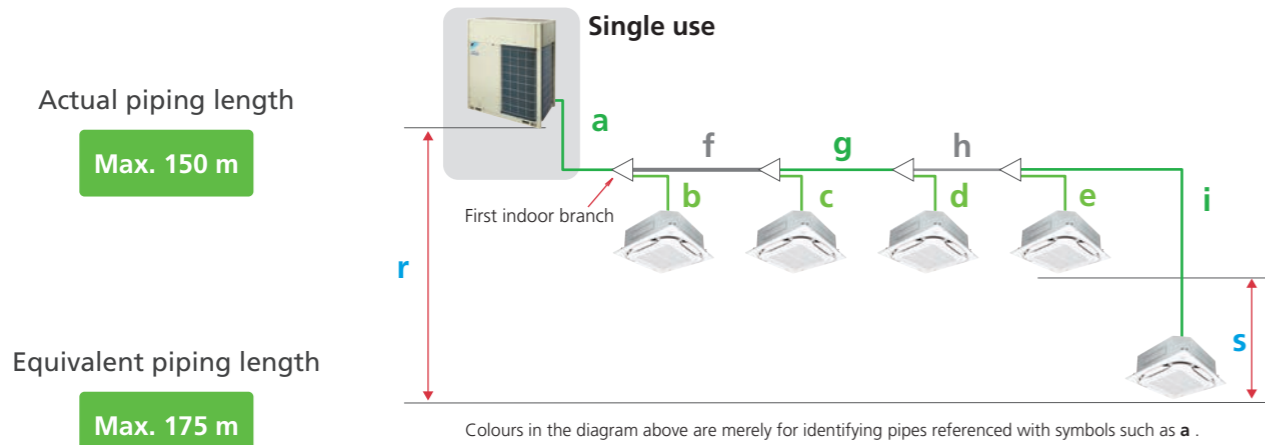

		Piping length	Example	
Maximum allowable piping length	Actual refrigerant piping length (Equivalent)	150 m (175 m)	a+f+g+h+i	
	Total piping length	300 m	a+b+c+d+e+f+g+h+i	
	Between the first indoor branch and the farthest indoor unit	40 m	f+g+h+i	
	Between the outdoor branch and the last outdoor unit (Equivalent)	10 m (13 m)	k+p	
		Height Difference	Example	
Maximum allowable height difference	Between the outdoor units (Multiple use)	5 m	q	
	Between the indoor units	15 m	s	
	Between the outdoor units and the indoor units	If the outdoor unit is above.	50 m	r
		If the outdoor unit is below.	40 m	r

### VRV III Q Series Heat Recovery

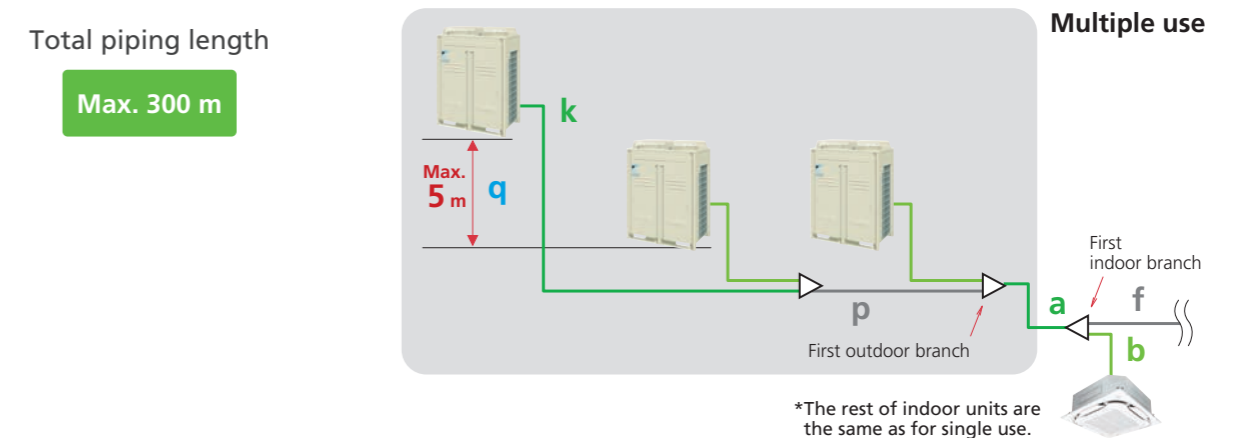
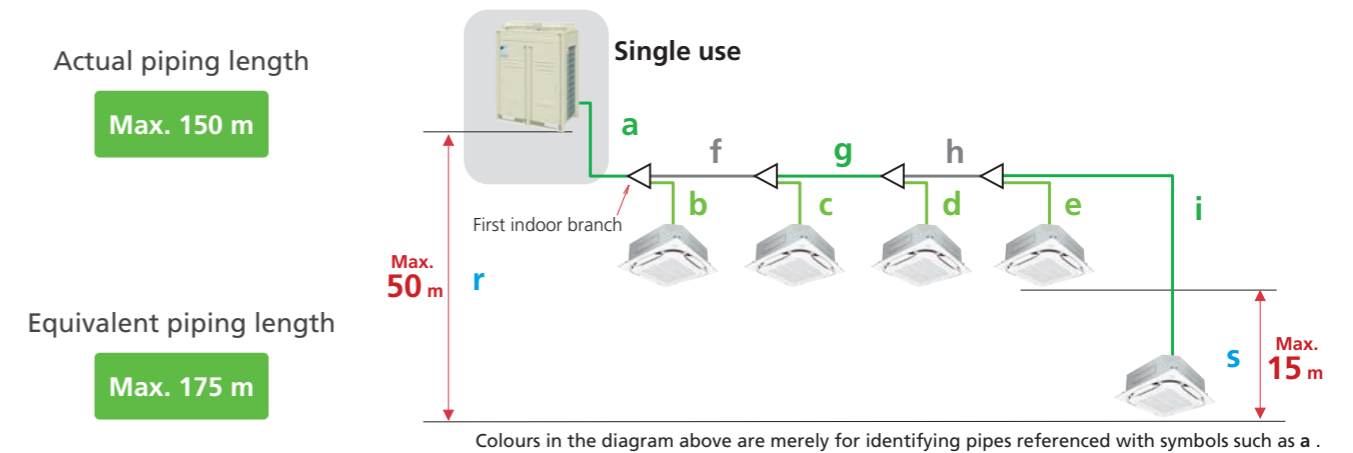

		Piping length	Example	
Maximum allowable piping length	Actual refrigerant piping length (Equivalent)	RQYQ8-48P: 150 m (175 m) RQYQ140P, RQCEQ-P: 120 m (150 m)	a+f+g+h+i	
	Total piping length	300 m	a+b+c+d+e+f+g+h+i	
	Between the first indoor branch and the farthest indoor unit	40 m	f+g+h+i	
	Between the outdoor branch and the last outdoor unit	10 m (13 m)	k+p	
		Height Difference	Example	
Maximum allowable height difference	Between the outdoor units (Multiple use)	5 m	q	
	Between the indoor units	15 m	s	
	Between the outdoor units and the indoor units	If the outdoor unit is above.	50 m	r
		If the outdoor unit is below.	40 m	r

# Guidelines for Reuse of Existing Refrigerant Piping

## Reusability of existing piping

### VRV IV Q series Heat Pump

Type of piping	Capacity	Piping size																			
		Liquid							Gas												
		φ 6.4	φ 9.5	φ 12.7	φ 15.9	φ 19.1	φ 22.2	φ 25.4	φ 28.6	φ 34.9	φ 41.3	φ 54.1	φ 12.7	φ 15.9	φ 19.1	φ 22.2	φ 25.4	φ 28.6	φ 34.9	φ 41.3	φ 54.1
Main piping	6 class	X	S	●			X	X	X	X	S	●			X	X	X	X	X	X	X
	8 class	X	S	●			X	X	X	X	S	●			X	X	X	X	X	X	X
	10 class	X	S	●			X	X	X	X	S	●			X	X	X	X	X	X	X
	12 class	X	X	●			X	X	X	X	X	●			X	X	X	X	X	X	X
	14 class	X	X	●			X	X	X	X	X	●			X	X	X	X	X	X	X
	16 class	X	X	●			X	X	X	X	X	●			X	X	X	X	X	X	X
	18 class	X	X	●			X	X	X	X	X	●			X	X	X	X	X	X	X
	20 class	X	X	●			X	X	X	X	X	●			X	X	X	X	X	X	X
	22 class	X	X	●			X	X	X	X	X	●			X	X	X	X	X	X	X
	24 class	X	X	●			X	X	X	X	X	●			X	X	X	X	X	X	X
	26 class	X	X	●			X	X	X	X	X	●			X	X	X	X	X	X	X
	28 class	X	X	●			X	X	X	X	X	●			X	X	X	X	X	X	X
	30 class	X	X	●			X	X	X	X	X	●			X	X	X	X	X	X	X
	32 class	X	X	●			X	X	X	X	X	●			X	X	X	X	X	X	X
	34 class	X	X	●			X	X	X	X	X	●			X	X	X	X	X	X	X
	36 class	X	X	●			X	X	X	X	X	●			X	X	X	X	X	X	X
	38 class	X	X	●			X	X	X	X	X	●			X	X	X	X	X	X	X
	40 class	X	X	●			X	X	X	X	X	●			X	X	X	X	X	X	X
	42 class	X	X	●			X	X	X	X	X	●			X	X	X	X	X	X	X
44 class	X	X	●			X	X	X	X	X	●			X	X	X	X	X	X	X	
46 class	X	X	●			X	X	X	X	X	●			X	X	X	X	X	X	X	
48 class	X	X	●			X	X	X	X	X	●			X	X	X	X	X	X	X	
From REFNET to REFNET *1	< 100	X	S	●			X	X	X	X	S	●			X	X	X	X	X	X	X
	100 ≤ X < 150	X	S	●			X	X	X	X	S	●			X	X	X	X	X	X	X
	150 ≤ X < 200	X	S	●			X	X	X	X	S	●			X	X	X	X	X	X	X
	200 ≤ X < 290	X	S	●			X	X	X	X	S	●			X	X	X	X	X	X	X
	290 ≤ X < 330	X	S	●			X	X	X	X	S	●			X	X	X	X	X	X	X
	330 ≤ X < 420	X	S	●			X	X	X	X	S	●			X	X	X	X	X	X	X
	420 ≤ X < 480	X	S	●			X	X	X	X	S	●			X	X	X	X	X	X	X
	480 ≤ X < 640	X	S	●			X	X	X	X	S	●			X	X	X	X	X	X	X
	640 ≤ X < 900	X	S	●			X	X	X	X	S	●			X	X	X	X	X	X	X
	900 ≤ X < 920	X	S	●			X	X	X	X	S	●			X	X	X	X	X	X	X
	920 ≤ X	X	S	●			X	X	X	X	S	●			X	X	X	X	X	X	X
From REFNET to indoor unit*2	20-40 class	S	●				X	X	X	X	S	●			X	X	X	X	X	X	X
	50 class	S	●				X	X	X	X	S	●			X	X	X	X	X	X	X
	63-80 class	X	S	●			X	X	X	X	S	●			X	X	X	X	X	X	X
	100-125 class	X	S	●			X	X	X	X	S	●			X	X	X	X	X	X	X
	140-145 class	X	S	●			X	X	X	X	S	●			X	X	X	X	X	X	X
	180 class	X	S	●			X	X	X	X	S	●			X	X	X	X	X	X	X
	200 class	X	S	●			X	X	X	X	S	●			X	X	X	X	X	X	X
	250 class	X	S	●			X	X	X	X	S	●			X	X	X	X	X	X	X

● : Piping size of conventional R-22, R-407C model  
 ○ : Piping size of conventional R-410A model  
 S : Standard piping size of VRV IV Q series  
 ● : Possible  
 ○ : Standard piping size of VRV IV Q series. However, when equivalent piping length between outdoor unit and indoor unit is 90 m or more, size of main piping must be increased.  
 X : Not possible

\*1 Piping between REFNETs depends on total capacity index of indoor units connected below each REFNET. It cannot exceed piping size of upstream side.  
 \*2 Piping from REFNET to indoor unit depends on the capacity of the connected indoor unit. It cannot exceed piping size of upstream side.

### VRV III Q series Heat Recovery

Type of piping	Capacity	Piping size																								
		Liquid										Suction gas					High and low pressure gas									
		φ 6.4	φ 9.5	φ 12.7	φ 15.9	φ 19.1	φ 22.2	φ 25.4	φ 28.6	φ 34.9	φ 41.3	φ 9.5	φ 12.7	φ 15.9	φ 19.1	φ 22.2	φ 25.4	φ 28.6	φ 34.9	φ 9.5	φ 12.7	φ 15.9	φ 19.1	φ 22.2	φ 25.4	φ 28.6
Main piping	10 class	X	S	●			X	X	X	X	S	●			X	X	X	X	X	X	X	X	X	X	X	X
	13 class	X	S	●			X	X	X	X	S	●			X	X	X	X	X	X	X	X	X	X	X	X
	16 class	X	X	●			X	X	X	X	X	●			X	X	X	X	X	X	X	X	X	X	X	X
	18 class	X	X	●			X	X	X	X	X	●			X	X	X	X	X	X	X	X	X	X	X	X
	20 class	X	X	●			X	X	X	X	X	●			X	X	X	X	X	X	X	X	X	X	X	X
	22 class	X	X	●			X	X	X	X	X	●			X	X	X	X	X	X	X	X	X	X	X	X
	24 class	X	X	●			X	X	X	X	X	●			X	X	X	X	X	X	X	X	X	X	X	X
	26 class	X	X	●			X	X	X	X	X	●			X	X	X	X	X	X	X	X	X	X	X	X
	28 class	X	X	●			X	X	X	X	X	●			X	X	X	X	X	X	X	X	X	X	X	X
	30 class	X	X	●			X	X	X	X	X	●			X	X	X	X	X	X	X	X	X	X	X	X
	From REFNET to REFNET *1	< 50	S	●				X	X	X	X	S	●			X	X	X	X	X	X	X	X	X	X	X
	50 ≤ X < 100	X	S	●			X	X	X	X	S	●			X	X	X	X	X	X	X	X	X	X	X	
	100 ≤ X < 150	X	S	●			X	X	X	X	S	●			X	X	X	X	X	X	X	X	X	X	X	
	150 ≤ X < 160	X	S	●			X	X	X	X	S	●			X	X	X	X	X	X	X	X	X	X	X	
	160 ≤ X < 200	X	S	●			X	X	X	X	S	●			X	X	X	X	X	X	X	X	X	X	X	
	200 ≤ X < 290	X	S	●			X	X	X	X	S	●			X	X	X	X	X	X	X	X	X	X	X	
	290 ≤ X < 330	X	S	●			X	X	X	X	S	●			X	X	X	X	X	X	X	X	X	X	X	
	330 ≤ X < 420	X	S	●			X	X	X	X	S	●			X	X	X	X	X	X	X	X	X	X	X	
	420 ≤ X < 480	X	S	●			X	X	X	X	S	●			X	X	X	X	X	X	X	X	X	X	X	
	480 ≤ X < 640	X	S	●			X	X	X	X	S	●			X	X	X	X	X	X	X	X	X	X	X	
	640 ≤ X < 700	X	S	●			X	X	X	X	S	●			X	X	X	X	X	X	X	X	X	X	X	
	700 ≤ X < 900	X	S	●			X	X	X	X	S	●			X	X	X	X	X	X	X	X	X	X	X	
	900 ≤ X	X	S	●			X	X	X	X	S	●			X	X	X	X	X	X	X	X	X	X	X	
From BS to indoor unit*2	20-40 class	S	●				X	X	X	X	S	●			X	X	X	X	X	X	X	X	X	X	X	
	50 class	S	●				X	X	X	X	S	●			X	X	X	X	X	X	X	X	X	X	X	
	63 class	X	S	●			X	X	X	X	S	●			X	X	X	X	X	X	X	X	X	X	X	
	80 class	X	S	●			X	X	X	X	S	●			X	X	X	X	X	X	X	X	X	X	X	
	100-125 class	X	S	●			X	X	X	X	S	●			X	X	X	X	X	X	X	X	X	X	X	
	140-145 class	X	S	●			X	X	X	X	S	●			X	X	X	X	X	X	X	X	X	X	X	
	180 class	X	S	●			X	X	X	X	S	●			X	X	X	X	X	X	X	X	X	X	X	
	200 class	X	S	●			X	X	X	X	S	●			X	X	X	X	X	X	X	X	X	X	X	
	250 class	X	S	●			X	X	X	X	S	●			X	X	X	X	X	X	X	X	X	X	X	

● : Piping size of conventional R-22, R-407C model  
 ○ : Piping size of conventional R-410A model  
 S : Standard piping size of VRV III Q series  
 ● : Possible  
 ○ : Standard piping size of VRV III Q series. However, when equivalent piping length between outdoor unit and indoor unit is 90 m or more, size of main piping must be increased.  
 X : Not possible

\*1 Piping between REFNETs depends on total capacity index of indoor units connected below each REFNET. It cannot exceed piping size of upstream side.  
 \*2 Piping from BS to indoor unit depends on the capacity of the connected indoor unit. It cannot exceed piping size of upstream side.

# Outdoor Unit Lineup

## VRV IV Q Series Heat Pump

### Enhanced lineup to 2 types

#### Lineup

		6	8	10	12	14	16	18	20	22	24	26	28	30	32	34	36	38	40	42	44	46	48	
VRV IV Q Series	Standard Type	●	●	●	●	●	●	●	●	●	●	●	●	●	●	●	●	●	●	●	●	●	●	●
	Space Saving Type							●	●						●	●	●	●	●	●	●	●	●	●

### Outdoor unit combinations

#### Standard Type

class	kW	Capacity index	Model name	Combination	Outdoor unit multi connection piping kit*1	Total capacity index of connectable indoor units*3	Maximum number of connectable indoor units*2
6	16.0	150	RQYQ6T	RQYQ6T	—	75 to 195	9
8	22.4	200	RQYQ8T	RQYQ8T	—	100 to 260	13
10	28.0	250	RQYQ10T	RQYQ10T	—	125 to 325	16
12	33.5	300	RQYQ12T	RQYQ12T	—	150 to 390	19
14	40.0	350	RQYQ14T	RQYQ14T	—	175 to 455	22
16	45.0	400	RQYQ16T	RQYQ16T	—	200 to 520	26
18	50.4	450	RQYQ18TN	RQYQ8T + RQYQ10T	BHFP22P100	225 to 585	29
20	55.9	500	RQYQ20TN	RQYQ8T + RQYQ12T		250 to 650	32
22	61.5	550	RQYQ22TN	RQYQ10T + RQYQ12T		275 to 715	35
24	67.0	600					



# Outdoor Unit Lineup

## VRV III Q Series Heat Recovery

### Outdoor unit lineup

class	10	13	16	18	20	22	24	26	28	30
VRV III Q Series	●	●	●	●	●	●	●	●	●	●

### Outdoor unit combinations

class	kW	Capacity index	Model name	Combination	Outdoor unit multi connection piping kit*1	Total capacity index of connectable indoor units*2 *3			Maximum number of connectable indoor units
						Combination (%)			
						50%	100%	130%	
10	28.0	250	RQCEQ280P	RREQ140P+RREQ140P	BHFP26P36C	125	250	325	16
13	36.0	325	RQCEQ360P	RREQ180P+RREQ180P		162.5	325	422.5	21
16	46.0	400	RQCEQ460P	RREQ140P+RREQ140P+RREQ180P	BHFP26P63C	200	400	520	26
18	50.0	450	RQCEQ500P	RREQ140P+RREQ180P+RREQ180P		225	450	585	29
20	54.0	500	RQCEQ540P	RREQ180P+RREQ180P+RREQ180P		250	500	650	32
22	63.6	550	RQCEQ636P	RREQ212P+RREQ212P+RREQ212P		275	550	715	35
24	71.2	600	RQCEQ712P	RREQ140P+RREQ180P+RREQ180P+RREQ212P	BHFP26P84C	300	600	780	39
26	74.4	650	RQCEQ744P	RREQ140P+RREQ180P+RREQ212P+RREQ212P		325	650	845	42
28	81.6	700	RQCEQ816P	RREQ180P+RREQ212P+RREQ212P+RREQ212P		350	700	910	45
30	84.8	750	RQCEQ848P	RREQ212P+RREQ212P+RREQ212P		375	750	975	48

\*1 The outdoor unit multi connection piping kit (separately sold) is required for multiple connections.

\*2 Total capacity index of connectable indoor units must be 50%~130% of the capacity index of the outdoor units.

\*3 For indoor units used for cooling only (do not connect to BS unit when using for heat recovery), total capacity index must be 50% or less than the capacity index of the outdoor units.

\*4 When outdoor-air processing units and standard indoor units are connected, the total connection capacity index of the outdoor-air processing units must not exceed 30% of the capacity index of the outdoor units. And the connection ratio must not exceed 100%.

# Indoor Unit Lineup

### Wide variety of indoor units

Category	Type	Model Name	Capacity Range (kW)															
			20	25	32	40	50	63	71	80	100	125	140	145	160	180	200	250
			Capacity Index	20	25	31.25	40	50	62.5	71	80	100	125	140	145	160	180	200
Ceiling Mounted Cassette	Round Flow Cassette with Sensing and Streamer	<b>New</b> FXFTQ-AVM	●	●	●	●	●	●	●	●	●	●	●	●	●	●	●	
	Round Flow Cassette with Sensing	FXFSQ-AVM	●	●	●	●	●	●	●	●	●	●	●	●	●	●	●	
	Round Flow Cassette	FXFQ-AVM	●	●	●	●	●	●	●	●	●	●	●	●	●	●	●	
	Compact Multi Flow Cassette	<b>New</b> FXZQ-BVM	●	●	●	●	●	●	●	●	●	●	●	●	●	●	●	
	Double Flow Cassette	<b>New</b> FXCQ-BVM	●	●	●	●	●	●	●	●	●	●	●	●	●	●	●	
Ceiling Concealed Duct	Single Flow Cassette	FXEQ-AV36	●	●	●	●	●	●	●	●	●	●	●	●	●	●	●	
	Slim Duct (Standard)	FXDQ-PDVE (700 mm width type)	●	●	●	●	●	●	●	●	●	●	●	●	●	●	●	
		FXDQ-NDVE (900/1,100 mm width type)	●	●	●	●	●	●	●	●	●	●	●	●	●	●	●	
	Slim Duct (Compact)	FXDQ-TV1C(A)	●	●	●	●	●	●	●	●	●	●	●	●	●	●	●	
	Middle Static Pressure Duct	FXSQ-PAVE	●	●	●	●	●	●	●	●	●	●	●	●	●	●	●	
		FXDYQ-MAV1	●	●	●	●	●	●	●	●	●	●	●	●	●	●	●	
	Middle-High Static Pressure Duct	FXMQ-PAVE	●	●	●	●	●	●	●	●	●	●	●	●	●	●	●	
	High Static Pressure Duct	FXMQ-PV1A	●	●	●	●	●	●	●	●	●	●	●	●	●	●	●	
	Outdoor-Air Processing Unit	<b>New</b> FXMQ-AFVM	●	●	●	●	●	●	●	●	●	●	●	●	●	●	●	
	Ceiling Suspended	4-Way Flow Ceiling Suspended	FXUQ-AVEB	●	●	●	●	●	●	●	●	●	●	●	●	●	●	●
Ceiling Suspended		FXHQ-MAVE <b>New</b> FXHQ-BVM	●	●	●	●	●	●	●	●	●	●	●	●	●	●	●	
Wall Mounted	FXAQ-AVM	●	●	●	●	●	●	●	●	●	●	●	●	●	●	●	●	
Floor Standing	Floor Standing	FXLQ-MAVE	●	●	●	●	●	●	●	●	●	●	●	●	●	●	●	
	Concealed Floor Standing	FXNQ-MAVE	●	●	●	●	●	●	●	●	●	●	●	●	●	●	●	
Heat Reclaim Ventilator	VAM-HVE	Airflow rate 150-2000 m³/h																

Notes:

1. It is not possible to combine old R-22 and new R-410A indoor units in one system due to incompatibility of communication.
2. It is not possible to keep R-407C indoor units.

# Outdoor Units

## Specifications

### VRV IV Q Series

#### Standard Type

MODEL		RQYQ6TY1A(E)	RQYQ8TY1A(E)	RQYQ10TY1A(E)	RQYQ12TY1A(E)	RQYQ14TY1A(E)	RQYQ16TY1A(E)	RQYQ18TNY1A(E)	RQYQ20TNY1A(E)	RQYQ22TNY1A(E)	RQYQ24TNY1A(E)	RQYQ26TNY1A(E)	RQYQ28TNY1A(E)	RQYQ30TNY1A(E)	RQYQ32TNY1A(E)	
Combination units		—	—	—	—	—	—	—	—	—	—	—	—	—	—	
Power supply		3-phase 4-wire system, 380-415 V, 50 Hz							3-phase 4-wire system, 380-415 V, 50 Hz							
Cooling capacity	Btu/h	54,600	76,400	95,500	114,000	136,000	154,000	172,000	191,000	210,000	229,000	251,000	268,000	290,000	307,000	
	kW	16.0	22.4	28.0	33.5	40.0	45.0	50.4	55.9	61.5	67.0	73.5	78.5	85.0	90.0	
Heating capacity	Btu/h	61,400	85,300	107,000	128,000	154,000	171,000	193,000	213,000	235,000	256,000	281,000	299,000	324,000	345,000	
	kW	18.0	25.0	31.5	37.5	45.0	50.0	56.5	62.5	69.0	75.0	82.5	87.5	95.0	101	
Power consumption	Cooling	3.63	5.21	7.29	9.01	10.9	13.0	12.5	14.2	16.3	18.0	19.9	22.0	23.9	26.3	
	Heating	3.99	5.69	7.29	9.06	11.1	12.8	13.0	14.8	16.4	18.1	20.2	21.9	23.9	26.2	
Capacity control	%	20-100			16-100	15-100	11-100	10-100	8-100				6-100		5-100	
Casing colour		Ivory white (5Y7.5/1)							Ivory white (5Y7.5/1)							
Compressor	Type	Hermetically Sealed Scroll Type							Hermetically Sealed Scroll Type							
	Motor output	kW	2.4x1	3.4x1	4.1x1	5.2x1	(2.9x1)+(3.3x1)	(3.6x1)+(3.7x1)	(3.4x1)+(4.1x1)	(3.4x1)+(5.2x1)	(4.1x1)+(5.2x1)	(5.2x1)+(5.2x1)	(5.2x1)+(2.9x1)+(3.3x1)	(5.2x1)+(3.6x1)+(3.7x1)	(2.9x1)+(3.3x1)+(3.6x1)+(3.7x1)	(2.9x1)+(3.3x1)+(4.4x1)+(4.0x1)
Airflow rate	ℓ/s	1,983	2,616	2,749	2,966	3,883		2,616+2,749	2,616+2,966	2,749+2,966	2,966+2,966	2,966+3,883		3,883+3,883		
	m <sup>3</sup> /min	119	157	165	178	233		157+165	157+178	165+178	178+178	178+233		233+233		
Dimensions (HxWxD)	mm	1,657X930X765				1,657X1,240X765		(1,657x930x765)+(1,657x930x765)				(1,657x930x765)+(1,657x1,240x765)		(1,657x1,240x765)+(1,657x1,240x765)		
Machine weight	kg	185		195		285		185+195		195+195		195+285		285+285	285+300	
Sound level	dB(A)	55	56	57	59	60	61	60	61	61	62	63	63	64		
Sound power	dB(A)	75	76	78	79	80	83	80	81	82	82	83	84	85		
Operation range	Cooling	°CDB -5 to 49							°CDB -5 to 49							
	Heating	°CWB -20 to 15.5							°CWB -20 to 15.5							
Refrigerant	Type	R-410A							R-410A							
	Charge	kg	5.9		6.0	6.3	10.3	10.4	5.9+6.0	5.9+6.3	6.0+6.3	6.3+6.3	6.3+10.3	6.3+10.4	10.3+10.4	10.3+11.7
Piping connections	Liquid	mm φ 9.5(Brazing)				φ 12.7(Brazing)		φ 15.9(Brazing)				φ 19.1(Brazing)				
	Gas	mm φ 19.1(Brazing)		φ 22.2(Brazing)		φ 28.6(Brazing)		φ 28.6(Brazing)				φ 34.9(Brazing)				

#### Space Saving Type

MODEL		RQYQ34TNY1A(E)	RQYQ36TNY1A(E)	RQYQ38TNY1A(E)	RQYQ40TNY1A(E)	RQYQ42TNY1A(E)	RQYQ44TNY1A(E)	RQYQ46TNY1A(E)	RQYQ48TNY1A(E)	
Combination units		RQYQ10TY1A(E)	RQYQ12TY1A(E)	RQYQ12TY1A(E)	RQYQ12TY1A(E)	RQYQ12TY1A(E)	RQYQ12TY1A(E)	RQYQ14TY1A(E)	RQYQ14TY1A(E)	
Power supply		3-phase 4-wire system, 380-415 V, 50 Hz							3-phase 4-wire system, 380-415 V, 50 Hz	
Cooling capacity	Btu/h	324,000	345,000	362,000	382,000	406,000	423,000	444,000	461,000	
	kW	95.0	101	106	112	119	124	130	135	
Heating capacity	Btu/h	365,000	386,000	406,000	427,000	454,000	471,000	498,000	515,000	
	kW	107	113	119	125	133	138	146	151	
Power consumption	Cooling	25.3	27.0	29.6	31.0	32.9	35.0	37.2	39.3	
	Heating	25.4	27.2	29.9	30.9	33.0	34.7	37.3	39.0	
Capacity control	%	5-100			4-100			3-100		
Casing colour		Ivory white (5Y7.5/1)							Ivory white (5Y7.5/1)	
Compressor	Type	Hermetically Sealed Scroll Type							Hermetically Sealed Scroll Type	
	Motor output	kW	(4.1x1)+(5.2x1)+(5.2x1)	(5.2x1)+(5.2x1)+(5.2x1)	(3.4x1)+(5.2x1)+(4.4x1)+(4.0x1)	(5.2x1)+(5.2x1)+(3.6x1)+(3.7x1)	(5.2x1)+(2.9x1)+(3.3x1)+(3.6x1)+(3.7x1)	(5.2x1)+(3.6x1)+(3.7x1)	(2.9x1)+(3.3x1)+(2.9x1)+(3.3x1)+(4.4x1)+(4.0x1)	(2.9x1)+(3.3x1)+(3.6x1)+(3.7x1)+(4.4x1)+(4.0x1)
Airflow rate	ℓ/s	2,749+2,966+2,966	2,966+2,966+2,966	2,616+2,966+3,883	2,966+2,966+3,883	2,966+3,883+3,883			3,883+3,883+3,883	
	m <sup>3</sup> /min	165+178+178	178+178+178	157+178+233	178+178+233	178+233+233			233+233+233	
Dimensions (HxWxD)	mm	(1,657x930x765)+(1,657x930x765)+(1,657x930x765)		(1,657x930x765)+(1,657x930x765)+(1,657x1,240x765)		(1,657x930x765)+(1,657x1,240x765)+(1,657x1,240x765)		(1,657x1,240x765)+(1,657x1,240x765)+(1,657x1,240x765)		
Machine weight	kg	195+195+195		185+195+300	195+195+285	195+285+285		285+285+300		
Sound level	dB(A)	63	64	64	65	65	66	66	66	
Sound power	dB(A)	83	84	84	86	86	87	87	87	
Operation range	Cooling	°CDB -5 to 49							°CDB -5 to 49	
	Heating	°CWB -20 to 15.5							°CWB -20 to 15.5	
Refrigerant	Type	R-410A							R-410A	
	Charge	kg	6.0+6.3+6.3	6.3+6.3+6.3	5.9+6.3+11.7	6.3+6.3+10.4	6.3+10.3+10.4	6.3+10.4+10.4	10.3+10.3+11.7	10.3+10.4+11.7
Piping connections	Liquid	mm φ 19.1(Brazing)								
	Gas	mm φ 34.9(Brazing)			φ 41.3(Brazing)			φ 41.3(Brazing)		

MODEL		RQYQ18TY1A(E)	RQYQ20TY1A(E)
Combination units		—	—
Power supply		3-phase 4-wire system, 380-415 V, 50 Hz	
Cooling capacity	Btu/h	171,000	191,000
	kW	50.0	56.0
Heating capacity	Btu/h	191,000	215,000
	kW	56.0	63.0
Power consumption	Cooling	kW 15.4	18.0
	Heating	kW 15.1	17.5
Capacity control	%	10-100	8-100
Casing colour		Ivory white (5Y7.5/1)	
Compressor	Type	Hermetically Sealed Scroll Type	
	Motor output	kW	(4.4x1)+(4.0x1)
Airflow rate	ℓ/s	3,883	4,466
	m <sup>3</sup> /min	233	268
Dimensions (HxWxD)	mm	1,657x1,240x765	
Machine weight	kg	300	320
Sound level	dB(A)	62	65
Sound power	dB(A)	84	87
Operation range	Cooling	°CDB -5 to 49	
	Heating	°CWB -20 to 15.5	
Refrigerant	Type	R-410A	
	Charge	kg	11.7
Piping connections	Liquid	mm φ 15.9(Brazing)	
	Gas	mm φ 28.6(Brazing)	

Notes:  
 1. Models with (E) are the outdoor units with anti-corrosion specifications. Please refer to Engineering Data Book for details.  
 2. Specifications are based on the following conditions:  
 • Cooling: Indoor temp.: 27°CDB, 19°CWB, Outdoor temp.: 35°CDB, Equivalent piping length: 7.5 m, Height difference: 0 m.  
 • Heating: Indoor temp.: 20°CDB, Outdoor temp.: 7°CDB, 6°CWB, Equivalent piping length: 7.5 m, Height difference: 0 m.  
 • Sound level: Anechoic chamber conversion value, measured at a point 1 m in front of the unit at a height of 1.5 m. During actual operation, these values are normally somewhat higher as a result of ambient conditions and oil recovery mode. When there is concern for noise to the surrounding area such as residences, we recommend investigating the installation location and taking soundproofing measures.



# Outdoor Units

## Specifications

### VRV IV Q Series

Heat Pump

Space Saving Type

MODEL		RQYQ30TSY1A(E)	RQYQ32TSY1A(E)	RQYQ34TSY1A(E)	RQYQ36TSY1A(E)	RQYQ38TSY1A(E)	RQYQ40TSY1A(E)	RQYQ42TSY1A(E)	RQYQ44TSY1A(E)	RQYQ46TSY1A(E)	RQYQ48TSY1A(E)
Combination units		RQYQ12TY1A(E) RQYQ18TY1A(E)	RQYQ12TY1A(E) RQYQ20TY1A(E)	RQYQ16TY1A(E) RQYQ18TY1A(E)	RQYQ18TY1A(E)	RQYQ18TY1A(E) RQYQ20TY1A(E)	RQYQ20TY1A(E) RQYQ20TY1A(E)	RQYQ12TY1A(E) RQYQ12TY1A(E)	RQYQ12TY1A(E) RQYQ20TY1A(E)	RQYQ12TY1A(E) RQYQ16TY1A(E)	RQYQ12TY1A(E) RQYQ18TY1A(E)
Power supply		3-phase 4-wire system, 380-415 V, 50 Hz					3-phase 4-wire system, 380-415 V, 50 Hz				
Cooling capacity	Btu/h	285,000	305,000	324,000	341,000	362,000	382,000	399,000	420,000	440,000	457,000
	kW	83.5	89.5	95.0	100	106	112	117	123	129	134
Heating capacity	Btu/h	319,000	345,000	362,000	382,000	406,000	430,000	447,000	471,000	491,000	512,000
	kW	93.5	101	106	112	119	126	131	138	144	150
Power consumption	Cooling kW	24.2	26.8	28.4	30.8	33.4	36.0	33.0	35.6	37.2	39.6
	Heating kW	24.2	26.6	27.9	30.2	32.6	35.0	33.2	35.6	37.0	39.3
Capacity control	%	6-100					5-100				
Casing colour		Ivory white (5Y7.5/1)					Ivory white (5Y7.5/1)				
Compressor		Hermetically Sealed Scroll Type					Hermetically Sealed Scroll Type				
Motor output	Type	Hermetically Sealed Scroll Type					Hermetically Sealed Scroll Type				
	kW	(5.2x1)+(4.4x1)+(4.0x1)	(5.2x1)+(4.6x1)+(5.5x1)	(3.6x1)+(3.7x1)+(4.4x1)+(4.0x1)	(4.4x1)+(4.0x1)+(4.4x1)+(4.0x1)	(4.4x1)+(4.0x1)+(4.6x1)+(5.5x1)	(4.6x1)+(5.5x1)+(4.6x1)+(5.5x1)	(5.2x1)+(5.2x1)+(4.4x1)+(4.0x1)	(5.2x1)+(5.2x1)+(4.6x1)+(5.5x1)	(5.2x1)+(3.6x1)+(3.7x1)+(4.4x1)+(4.0x1)	(5.2x1)+(4.4x1)+(4.0x1)+(4.4x1)+(4.0x1)
Airflow rate	l/s	2,966+3,883	2,966+4,466	3,883+3,883		3,883+4,466	4,466+4,466	2,966+2,966+3,883	2,966+2,966+4,466	2,966+3,883+3,883	
	m³/min	178+233	178+268	233+233		233+268	268+268	178+178+233	178+178+268	178+233+233	
Dimensions (HxWxD)	mm	(1,657x930x765)+(1,657x1,240x765)		(1,657x1,240x765)+(1,657x1,240x765)		(1,657x1,240x765)+(1,657x1,240x765)		(1,657x930x765)+(1,657x930x765)+(1,657x1,240x765)		(1,657x930x765)+(1,657x1,240x765)+(1,657x1,240x765)	
Machine weight	kg	195+300	195+320	285+300	300+300	300+320	320+320	195+195+300	195+195+320	195+285+300	195+300+300
Sound level	dB(A)	64	66	65		67	68	65	67	66	
Sound power	dB(A)	85	88	87		89	90	86	87	88	
Operation range	Cooling °CDB	-5 to 49					-5 to 49				
	Heating °CWB	-20 to 15.5					-20 to 15.5				
Refrigerant	Type	R-410A					R-410A				
	Charge kg	6.3+11.7	6.3+11.8	10.4+11.7	11.7+11.7	11.7+11.8	11.8+11.8	6.3+6.3+11.7	6.3+6.3+11.8	6.3+10.4+11.7	6.3+11.7+11.7
Piping connections	Liquid mm	φ 19.1(Brazing)					φ 19.1(Brazing)				
	Gas mm	φ 34.9(Brazing)					φ 41.3(Brazing)				

Notes: 1. Models with (E) are the outdoor units with anti-corrosion specifications. Please refer to Engineering Data Book for details.  
2. Specifications are based on the following conditions;

• Cooling: Indoor temp.: 27°CDB, 19°CWB, Outdoor temp.: 35°CDB, Equivalent piping length: 7.5 m, Height difference: 0 m.  
• Heating: Indoor temp.: 20°CDB, Outdoor temp.: 7°CDB, 6°CWB, Equivalent piping length: 7.5 m, Height difference: 0 m.  
• Sound level: Anechoic chamber conversion value, measured at a point 1 m in front of the unit at a height of 1.5 m.

During actual operation, these values are normally somewhat higher as a result of ambient conditions and oil recovery mode. When there is concern for noise to the surrounding area such as residences, we recommend investigating the installation location and taking soundproofing measures.

Heat Recovery

### VRV III Q Series

MODEL		RQCEQ280PY1	RQCEQ360PY1	RQCEQ460PY1	RQCEQ500PY1	RQCEQ540PY1	RQCEQ636PY1	RQCEQ712PY1	RQCEQ744PY1	RQCEQ816PY1	RQCEQ848PY1	
Combination units		RQEQ140PY1 RQEQ140PY1	RQEQ180PY1 RQEQ180PY1	RQEQ140PY1 RQEQ180PY1	RQEQ140PY1 RQEQ180PY1	RQEQ180PY1 RQEQ180PY1	RQEQ212PY1 RQEQ212PY1	RQEQ140PY1 RQEQ180PY1	RQEQ140PY1 RQEQ212PY1	RQEQ180PY1 RQEQ212PY1	RQEQ212PY1 RQEQ212PY1	
Power supply		3-phase 4-wire system, 380-415 V, 50 Hz					3-phase 4-wire system, 380-415 V, 50 Hz					
Cooling capacity (*1) (*2)	Btu/h(*1)	96,200	124,000	158,000	172,000	186,000	218,000	245,000	256,000	280,000	291,000	
	kW(*1)	28.2	36.3	46.3	50.4	54.4	64.0	71.7	74.9	82.2	85.4	
Heating capacity	Btu/h	109,000	136,000	177,000	191,000	205,000	229,000	268,000	276,000	298,000	306,000	
	kW	32.0	40.0	52.0	56.0	60.0	67.2	78.4	80.8	87.2	89.6	
Power consumption	Cooling(*2) kW	7.04	10.3	12.2	13.9	15.5	21.9	21.2	23.3	27.1	29.2	
	Heating kW	8.00	10.7	13.4	14.7	16.1	17.7	20.7	21.2	23.1	23.6	
Capacity control	%	13-100	10-100	8-100	7-100		5-100					
Casing colour		Ivory white (5Y7.5/1)					Ivory white (5Y7.5/1)					
Compressor		Hermetically sealed scroll type					Hermetically sealed scroll type					
Motor output	Type	Hermetically sealed scroll type					Hermetically sealed scroll type					
	kW	2.8X2	3.3X2	2.8X2+3.3	2.8+3.3X2	3.3X3	3.6X3	2.8+3.3X2+3.6	2.8+3.3+3.6X2	3.3+3.6X3	3.6X4	
Airflow rate	l/s	1583+1583	1833+1833	1583+1583+1833	1583+1833+1833	1833+1833+1833		1583+1833+1833+1833		1833+1833+1833+1833		
	m³/min	95+95	110+110	95+95+110	95+110+110	110+110+110		95+110+110+110		110+110+110+110		
Dimensions (HXWXD)	mm	(1,680X635X765)+(1,680X635X765)		(1,680X635X765)+(1,680X635X765)+(1,680X635X765)			(1,680X635X765)+(1,680X635X765)+(1,680X635X765)+(1,680X635X765)					
Machine weight	kg	175+175		175+175+175			175+175+175+179		175+175+179+179		179+179+179+179	
Sound level	dB(A)	57	61	62	63	65	64	65	66	66		
Operation range	Cooling °CDB	-5 to 43					-5 to 43					
	Heating °CWB	-20 to 15.5					-20 to 15.5					
	Cooling & Heating °CWB	-6 to 15.5					-6 to 15.5					
Refrigerant	Type	R-410A					R-410A					
	Charge kg	10.3+10.3	10.6+10.6	10.3+10.3+10.6	10.3+10.6+10.6	10.6+10.6+10.6	11.2+11.2+11.2	10.3+10.6+10.6+11.2	10.3+10.6+11.2+11.2	10.6+11.2+11.2+11.2	11.2+11.2+11.2+11.2	
Piping connections	Liquid mm	φ 9.5 (Brazing)		φ 12.7 (Brazing)			φ 15.9 (Brazing)		φ 15.9 (Brazing)		φ 19.1 (Brazing)	
	Suction gas mm	φ 22.2 (Brazing)		φ 25.4 (Brazing)			φ 28.6 (Brazing)		φ 28.6 (Brazing)		φ 34.9 (Brazing)	
	High and low pressure gas mm	φ 19.1 (Brazing)		φ 22.2 (Brazing)			φ 25.4 (Brazing)		φ 25.4 (Brazing)		φ 28.6 (Brazing)	

Notes: Specifications are based on the following conditions;

• Cooling:(\*1) Indoor temp.: 27°CDB, 19.5°CWB, Outdoor temp.: 35°CDB, Equivalent piping length: 7.5 m, Height difference: 0 m.  
(\*2) Indoor temp.: 27°CDB, 19°CWB, Outdoor temp.: 35°CDB, Equivalent piping length: 7.5 m, Height difference: 0 m.  
• Heating: Indoor temp.: 20°CDB, Outdoor temp.: 7°CDB, 6°CWB, Equivalent piping length: 7.5 m, Height difference: 0 m.

• Sound level: Anechoic chamber conversion value, measured at a point 1 m in front of the unit at a height of 1.5 m.

During actual operation, these values are normally somewhat higher as a result of ambient conditions and oil recovery mode. When there is concern for noise to the surrounding area such as residences, we recommend investigating the installation location and taking soundproofing measures.

# VRV IV W SERIES

## Water Cooled System Suitable for Tall Multi-Storied Buildings

Heat Pump  
Heat Recovery  
**6 class—36 class**  
(16 kW) (101 kW)

- Water cooled system does not require to exchange heat with outdoor air
- Outside units can be installed indoors.
- The air conditioning operation is stable even when the outdoor air temperature is high

- Individual air conditioning is achieved via on-demand operation in each room.
- The length of the refrigerant piping can be minimized by installing outside units in proximity to indoor units.
- As refrigerant piping is connected to indoor units, it reduces the risks of indoor water leakage.

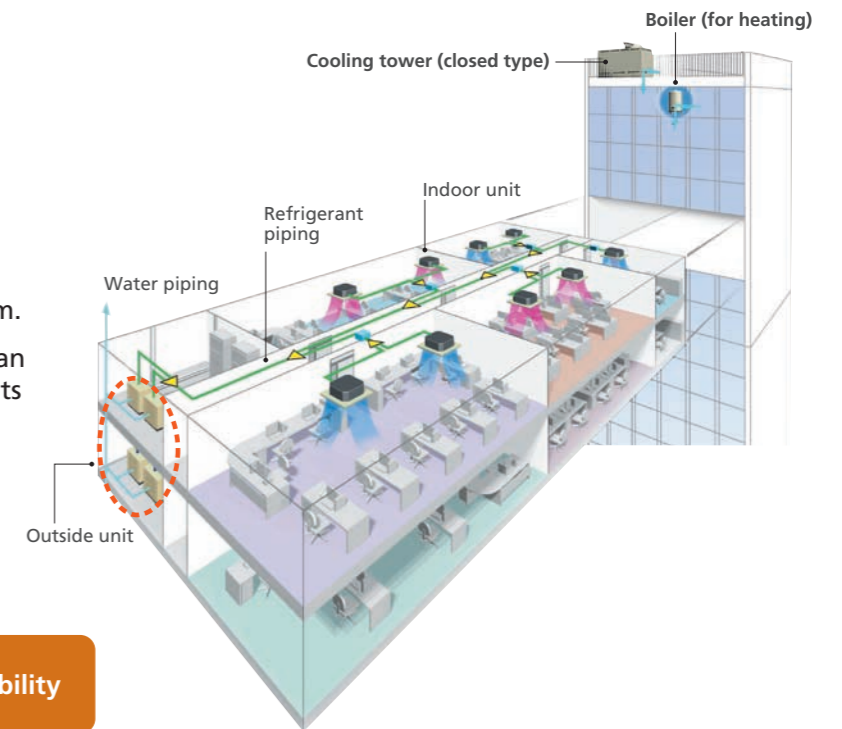

High installation flexibility

Design flexibility

### Design flexibility

#### High-rise buildings

Compact outside units can be easily installed in the machine rooms on each floor. It is adaptable to high-rise buildings.

#### Condominiums and detached houses

We offer an extensive lineup of small capacity outside units.

#### Underground shopping malls and subway

As heat exchanging with outdoor air is not required, individual air conditioning can be easily provided.

No balcony required

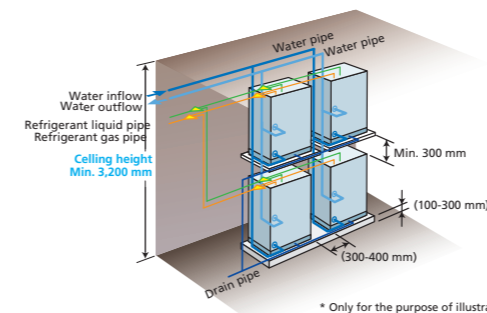

\* Only for the purpose of illustration.

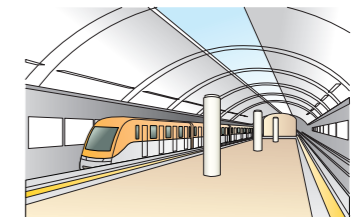
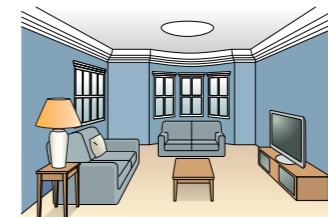

Single outside units  
**RWEYQ6-12T(2)YM**

Double outside units  
**RWEYQ14-24TYM**

Triple outside units  
**RWEYQ26-36TYM**



# Water Cooled VRV IV as a Retrofit Solution

A flexible system convenient for expansion/renovation

**Problems with existing water systems can be solved with minimal construction work.**

Indoor installation solves the puzzle of proper placement of outside units

It is possible to place the outside unit inside the building, it makes easier to adapt to different type of buildings and open to various kinds of creative building exteriors.

**Easy Installation**

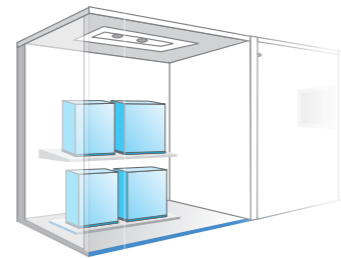

**Part of the old system can be retained**

The water cooled VRV IV W series can retain the cooling tower and boiler of the old system during renovation, effectively keeping costs down.

**Cost Saving**

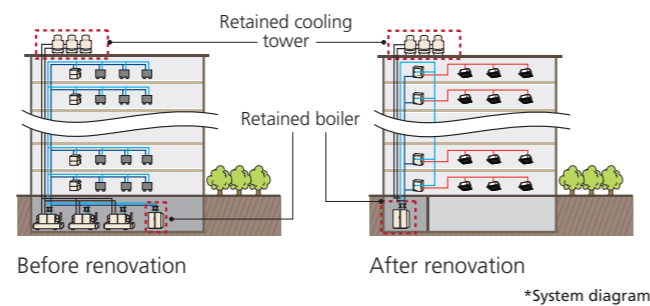

**The compact outside units facilitate the renovation process**

- The outside units are conveniently compact so transport by elevator is possible. It also effectively simplifies installation. This also saves a great deal of time and labor.
- The modular design enables a free and flexible configuration of the outside units. Also can save space for other purposes.

**Space Saving**

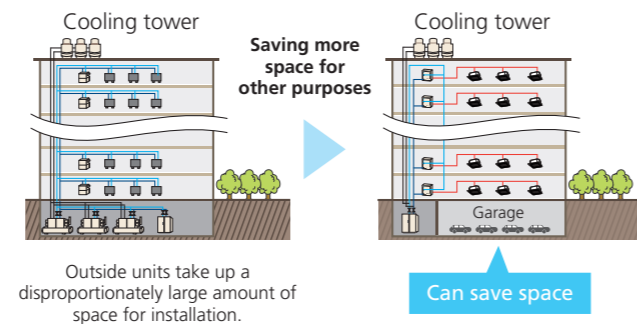

**Floor by floor renovation without disturbing other tenants**

Because equipment can be replaced in phases, installation adapts to the renovation plans of the customers and ensures that work performed on some floors and zones will not affect other tenants.

**Flexible Renovation**

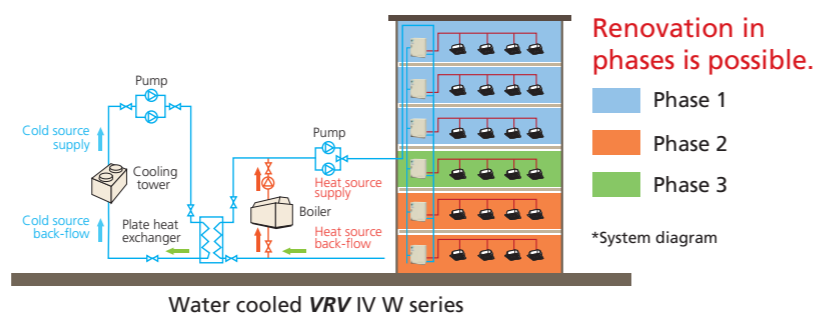

**Individual air conditioning comfort can be realized when and where it is actually required.**

Independent control provides greater comfort and convenience.

Each indoor unit can be independently controlled and adjusted according to each tenant's individual needs for temperature and air volume.

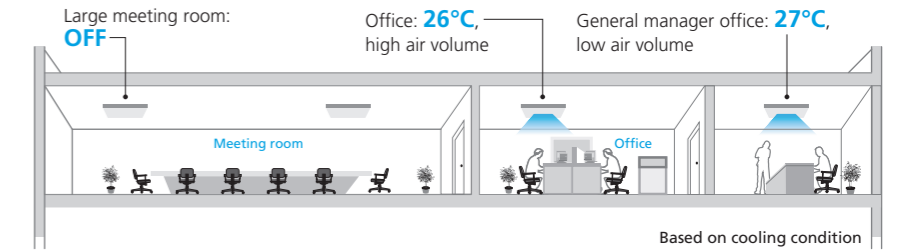

**Higher efficiency with partial load**

During actual operation, the load of an air conditioning system changes according to variations in weather conditions outside and indoor unit operation rates. Daikin's advanced DC inverter technology and advanced refrigerant control technology boasts a higher efficiency under partial load than in the rated operating conditions.

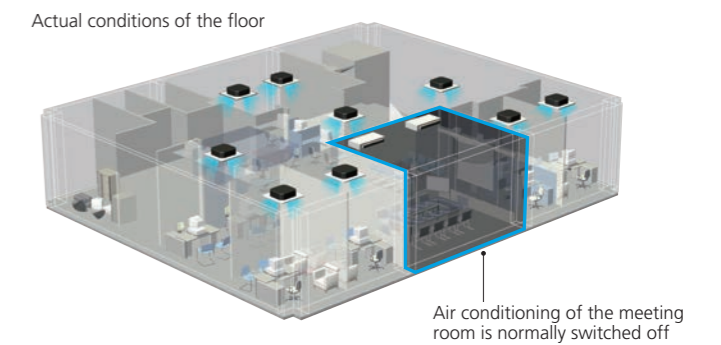

**Flexibly satisfies conditions for working overtime and times of insufficient load**

Each indoor unit can be independently controlled and adjusted according to each tenant's individual needs for temperature and air volume.

- Inconvenient transportation procedures are eliminated.
- Operation for each indoor unit can be precisely and individually set.

**Example of air conditioning control for different rooms of the same floor**

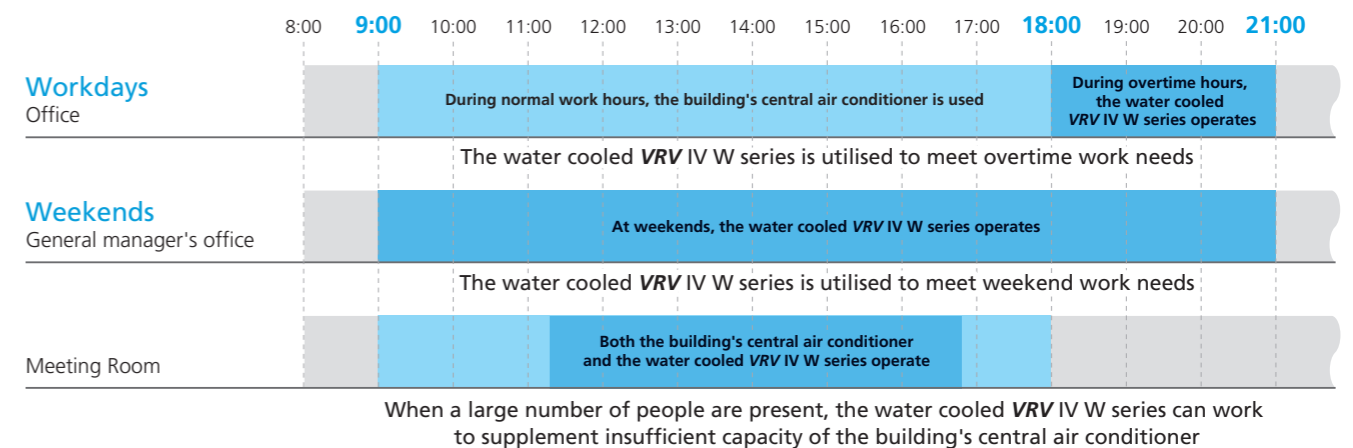

When a large number of people are present, the water cooled VRV IV W series can work to supplement insufficient capacity of the building's central air conditioner

# Easy Installation & Energy Saving

## Compact and lightweight

**VRV IV W SERIES**

Footprint : **0.43 m<sup>2</sup>**

Product Weight :  
(\*For 6 class, 8 class) **146 kg**



## Enhanced usability

### Centralised interlocking function

Centralised interlocking input operate by using an external control adaptor (DTA104A62).

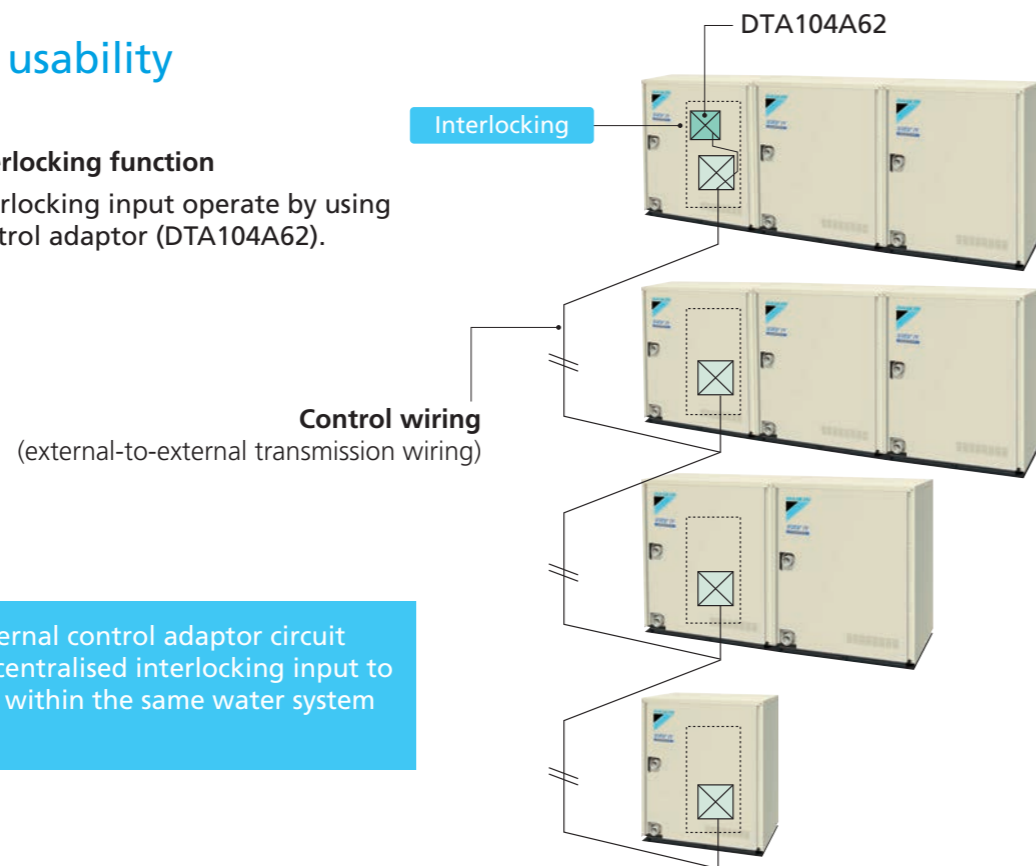

Using one external control adaptor circuit board makes centralised interlocking input to multiple units within the same water system possible.

## Enhanced lineup

**VRV IV W SERIES**

Wider capacity range from **6 to 36 class**



6 class, 8 class, 10 class, 12 class

6, 8, 10, 12 class      14, 16, 18, 20, 22, 24 class      26, 28, 30, 32, 34, 36 class



## Energy saving

### Higher Energy Efficiency Ratio (EER)

Cooling Operation EER

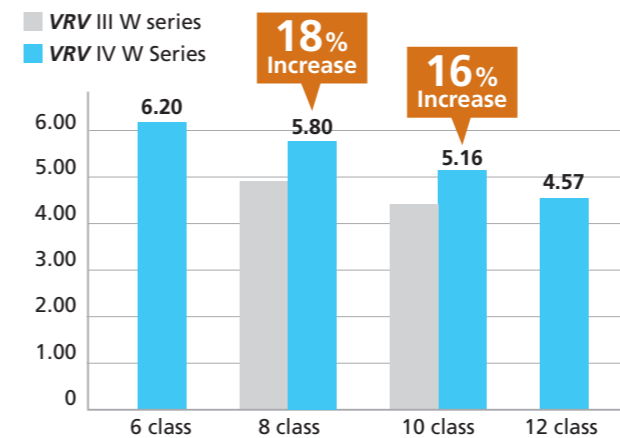

\*Cooling : Indoor temp.: 27°CDB, 19°CWB/inlet water temp.: 30°C, Equivalent piping length: 7.5 m, Height difference: 0 m.

### VRT control for optimal annual efficiency

VRT automatically adjusts refrigerant temperature to individual building and climate requirement, thus further improving annual energy efficiency and maintaining comfort.





# Maximum Comfort via Simultaneous Cooling and Heating

## Flexibility by simultaneous cooling and heating operation

### Situation

Recent office buildings are highly airtight and due to the use of computers, lighting equipment and other office equipments, **cooling load increases even in winter.**

### Need

These buildings require **flexible cooling and heating operation.**

### Solution

- Heat recovery system enables flexibility by simultaneous cooling and heating operation just using one VRV IV W system.
- Improves energy efficiency by recycling waste heat.

Heat recovery system offers simultaneous cooling and heating operation on the same floor!

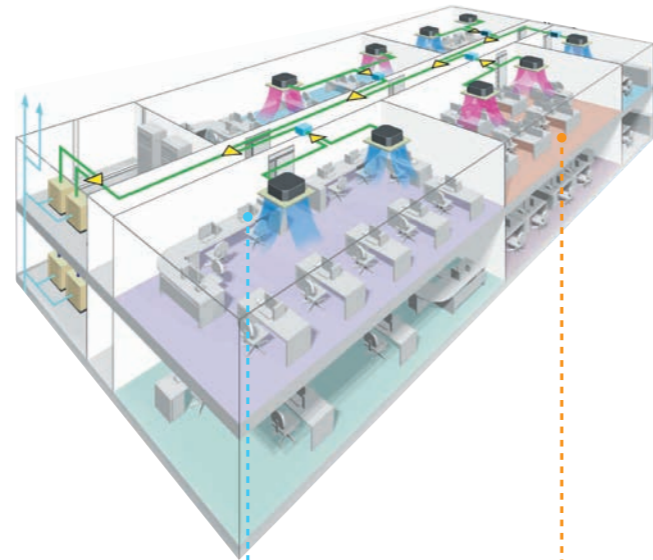

Hot area due to heat released by computers, etc.  
→Cooling ON

Cold area during winter due to cold air coming from windows  
→Heating ON

## The heat recovery system improves energy efficiency by recycling waste heat.

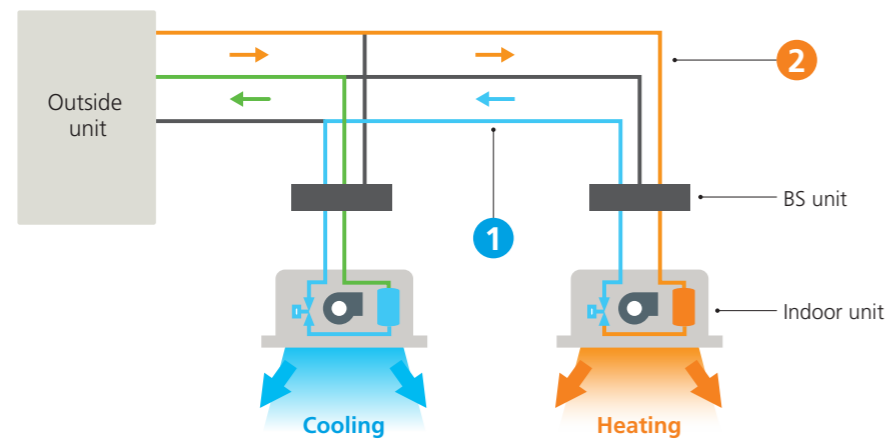

1 The (cold) waste heat from heating is used for the cooling operation.

2 The waste heat from cooling is used to generate heat that is needed for heating operation while conserving electricity.

## BS unit (Single type/Multi type)

See page 159 - 162

By adding suction gas piping and a BS unit (sold separately), simultaneous cooling and heating operation can be provided by a single system.

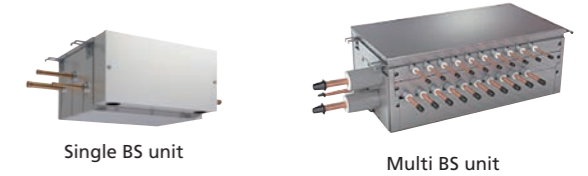

### Heat pump

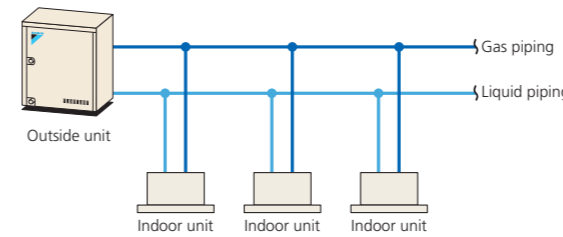

### Heat recovery

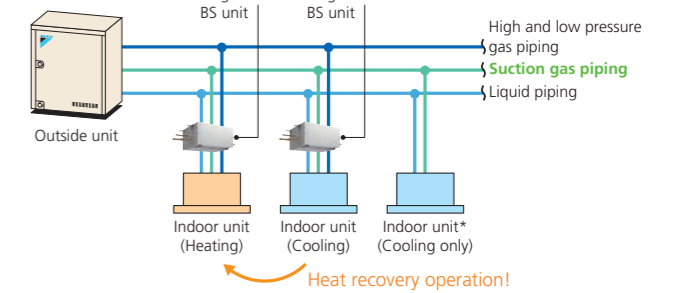

\* For indoor units used for cooling only (do not connect to BS unit when using for heat recovery), total capacity index must be 50% or less than the capacity index of the outside units.

## Application reference

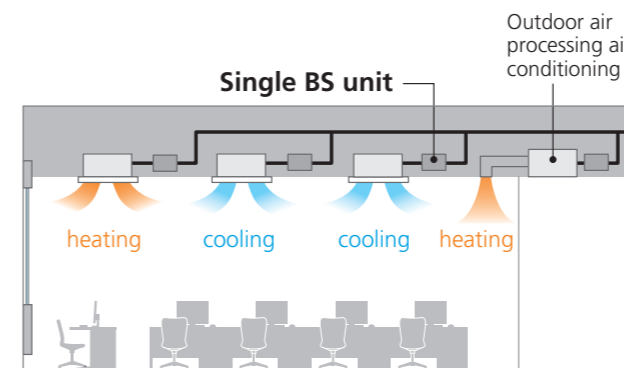

### Winter season (Office Building)

- Difference between the load of cold air and heat from room is large
- Can be used with the outdoor air processing air conditioning

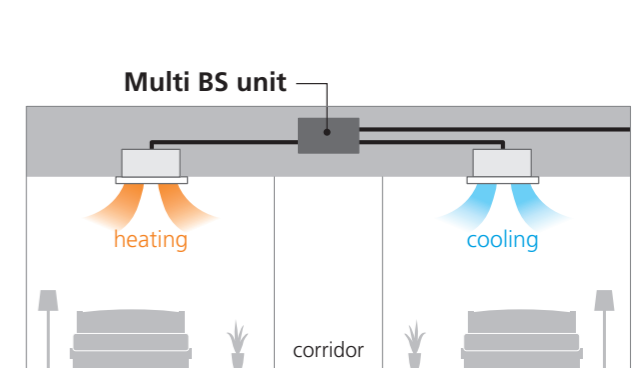

### Winter season (Hotel)

- Able to cater to individual heating and cooling requirement

# Flexible System Design

## Long piping length

Actual piping length

Max. 120 m

Equivalent piping length

Max. 140 m

Total piping length

Max. 300 m

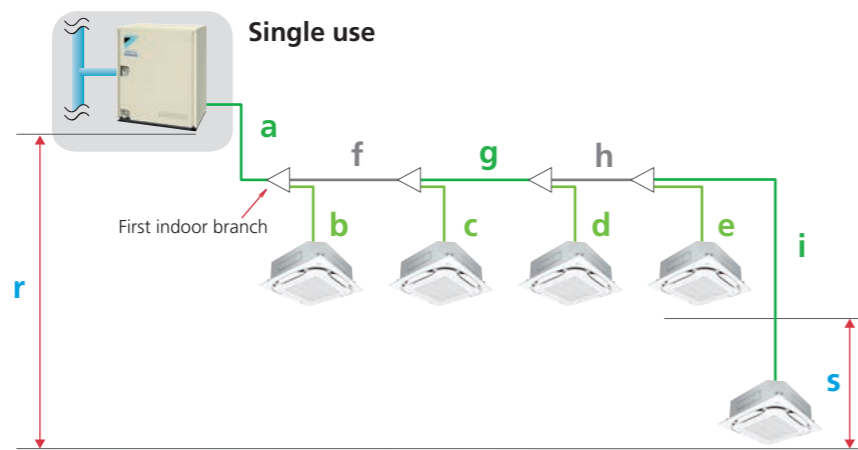

\*Colours in the diagram above are merely for identifying pipes referenced with symbols such as a.

	Actual piping length	Example	Equivalent piping length
Maximum allowable piping length	Refrigerant piping length	120 m	140 m
	Total piping length	300 m	—
	Between the first indoor branch and the farthest indoor unit	90 m*1	—
	Between the first outside branch and the last outside unit	10 m	13 m
Maximum allowable height difference	Between the outside units (multiple use)	2 m	—
	Between the indoor units	15 m	—
	Between the outside units and the indoor units	If the outside unit is above, 50 m If the outside unit is below, 40 m	r

\*1 No special requirements up to 40 m. The maximum actual piping length can be 90 m, depending on conditions. The VRV IV W series is easy to extend to 90 m by lessening the conditions from conventional VRV III W models. Be sure to refer to the Engineering Data Book for details of these conditions and requirements.

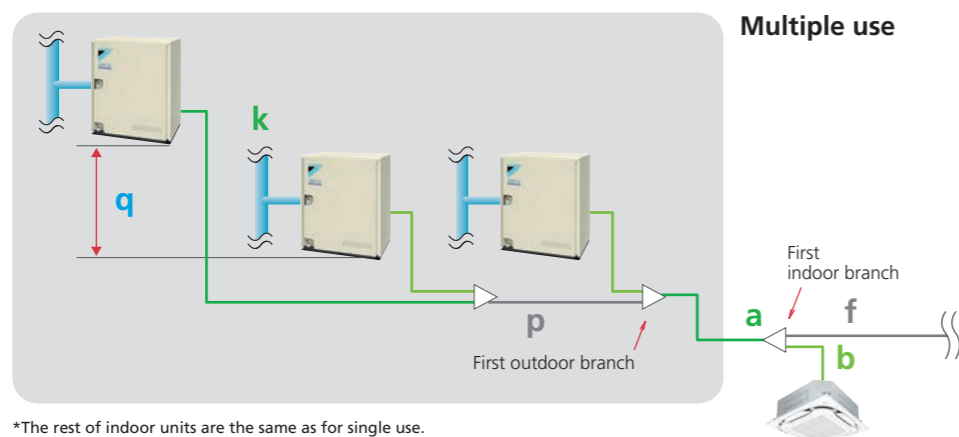

\*The rest of indoor units are the same as for single use.

# Advanced Technologies

## High efficiency compressor to achieve a high performance

The reluctance DC motor uses 2 different types of torque, neodymium magnet and reluctance torque. It generates more power with a smaller electric power and saves energy.

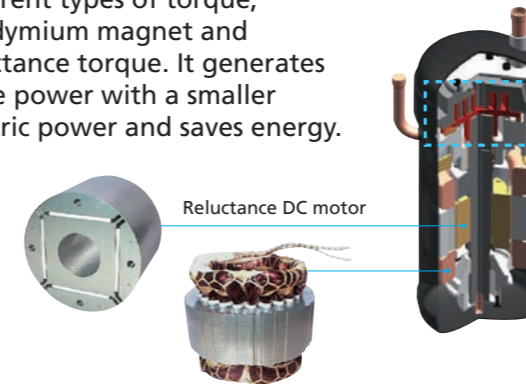

## SMT\* packaging technology

- Improves the anti-clutter performance.
- Protects your computer boards from the adverse effects of sandy climates and humid weather.

\*SMT: Surface mounted technology

Computer control board surface adopting SMT packaging technology

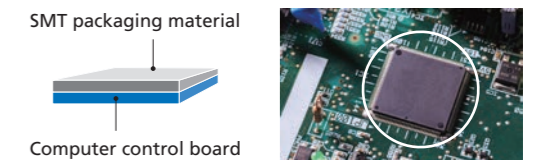

## Minimize performance degradation from refrigeration oil in all stages of operation

Surplus oil is stored in the receiver and automatically controls the amount of refrigeration oil in the refrigerant cycle. This prevents a reduction in performance for heat exchanger.

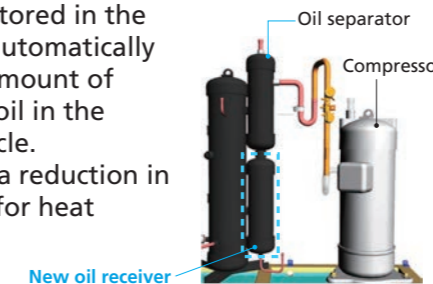

## Function of information display by luminous digital tube

VRV IV W series utilises a bright 7-segment digital display to convey operational status and facilitate simple installation and after-sales service.

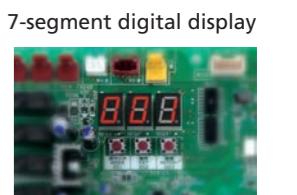

Displays system operation information directly

## Automatic sequencing operation

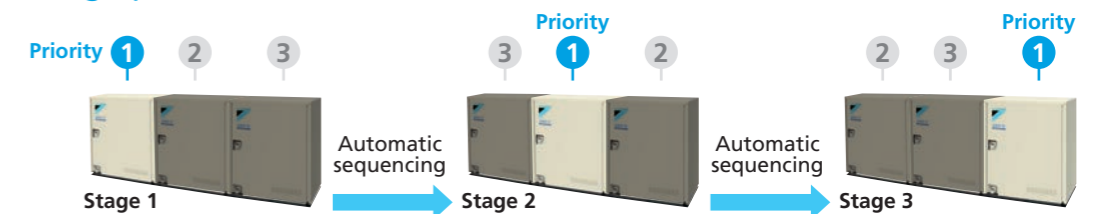

## Auto-restart technology

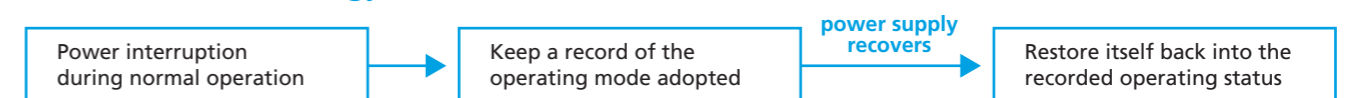

## Refrigerant pressure detection technology

- Utilizes temperature sensors to detect the system's operating status.
- Employs high and low pressure sensors to carry out quick, comprehensive and accurate detection of the refrigerant status.



# Outside Unit Lineup

## VRV IV W Series

### Lineup

Capacity Range	class	6	8	10	12	14	16	18	20	22	24	26	28	30	32	34	36
	kW	16.0	22.4	28.0	33.5	38.4	44.8	50.4	56.0	61.5	67.0	72.8	78.4	84.0	89.5	95.0	101
VRV IV W SERIES		●	●	●	●	●	●	●	●	●	●	●	●	●	●	●	●

### Outside unit combinations

class	kW	Capacity index	Model	Combination	Total capacity index of connectable indoor units*2	Maximum number of connectable indoor units
6	16.0	150	RWEYQ6T2	RWEYQ6T2 × 1	75 to 195	9
8	22.4	200	RWEYQ8T	RWEYQ8T × 1	100 to 260	13
10	28.0	250	RWEYQ10T	RWEYQ10T × 1	125 to 325	16
12	33.5	300	RWEYQ12T	RWEYQ12T × 1	150 to 390	19
14	38.4	350	RWEYQ14T*1	RWEYQ6T2 + RWEYQ8T	175 to 455	22
16	44.8	400	RWEYQ16T*1	RWEYQ8T × 2	200 to 520	26
18	50.4	450	RWEYQ18T*1	RWEYQ8T + RWEYQ10T	225 to 585	29
20	56.0	500	RWEYQ20T*1	RWEYQ10T × 2	250 to 650	32
22	61.5	550	RWEYQ22T*1	RWEYQ10T + RWEYQ12T	275 to 715	35
24	67.0	600	RWEYQ24T*1	RWEYQ12T × 2	300 to 780	39
26	72.8	650	RWEYQ26T*1	RWEYQ8T × 2 + RWEYQ10T	325 to 845	42
28	78.4	700	RWEYQ28T*1	RWEYQ8T + RWEYQ10T × 2	350 to 910	45
30	84.0	750	RWEYQ30T*1	RWEYQ10T × 3	375 to 975	48
32	89.5	800	RWEYQ32T*1	RWEYQ10T × 2 + RWEYQ12T	400 to 1,040	52
34	95.0	850	RWEYQ34T*1	RWEYQ10T + RWEYQ12T × 2	425 to 1,105	55
36	101	900	RWEYQ36T*1	RWEYQ12T × 3	450 to 1,170	58

\*1. An outside unit multi connection piping kit (option) is necessary for multiple connections of 14 class systems and above.  
 \*2. Total capacity index of connectable indoor units must be 50%–130% of the capacity index of the outside units.

# Indoor Unit Lineup

### Enhanced range of choices

Category	Type	Model Name	Capacity Range (kW)																			
			20	25	32	40	50	63	71	80	100	125	140	145	160	180	200	250				
			Capacity Index																			
			20	25	31.25	40	50	62.5	71	80	100	125	140	145	160	180	200	250				
Ceiling Mounted Cassette	Round Flow Cassette with Sensing and Streamer	<b>New</b> FXFTQ-AVM	●	●	●	●	●	●	●	●	●	●	●	●	●	●	●	●	●	●		
	Round Flow Cassette with Sensing	FXFSQ-AVM	●	●	●	●	●	●	●	●	●	●	●	●	●	●	●	●	●	●		
	Round Flow Cassette	FXFQ-AVM	●	●	●	●	●	●	●	●	●	●	●	●	●	●	●	●	●	●		
	Compact Multi Flow Cassette	<b>New</b> FXZQ-BVM	●	●	●	●	●	●	●	●	●	●	●	●	●	●	●	●	●	●		
	Double Flow Cassette	<b>New</b> FXCQ-BVM	●	●	●	●	●	●	●	●	●	●	●	●	●	●	●	●	●	●		
	Single Flow Cassette	FXEQ-AV36	●	●	●	●	●	●	●	●	●	●	●	●	●	●	●	●	●	●		
Ceiling Concealed Duct	Slim Duct (Standard)	FXDQ-PDVE	●	●	●	●	●	●	●	●	●	●	●	●	●	●	●	●	●	●		
		FXDQ-NDVE	●	●	●	●	●	●	●	●	●	●	●	●	●	●	●	●	●	●		
	Slim Duct (Compact)	FXDQ-TV1C(A)	●	●	●	●	●	●	●	●	●	●	●	●	●	●	●	●	●	●		
	Middle Static Pressure Duct	FXSQ-PAVE	●	●	●	●	●	●	●	●	●	●	●	●	●	●	●	●	●	●		
		FXDYQ-MAV1	●	●	●	●	●	●	●	●	●	●	●	●	●	●	●	●	●	●		
	Middle-High Static Pressure Duct	FXMQ-PAVE	●	●	●	●	●	●	●	●	●	●	●	●	●	●	●	●	●	●		
High Static Pressure Duct	FXMQ-PV1A	●	●	●	●	●	●	●	●	●	●	●	●	●	●	●	●	●	●			
	Outdoor-Air Processing Unit	<b>New</b> FXMQ-AFVM	●	●	●	●	●	●	●	●	●	●	●	●	●	●	●	●	●	●		
Ceiling Suspended	4-Way Flow Ceiling Suspended	FXUQ-AVEB	●	●	●	●	●	●	●	●	●	●	●	●	●	●	●	●	●	●		
	Ceiling Suspended	<b>New</b> FXHQ-BVM	●	●	●	●	●	●	●	●	●	●	●	●	●	●	●	●	●	●		
Wall Mounted		FXAQ-AVM	●	●	●	●	●	●	●	●	●	●	●	●	●	●	●	●	●	●		
Floor Standing	Floor Standing	FXLQ-MAVE	●	●	●	●	●	●	●	●	●	●	●	●	●	●	●	●	●	●		
	Concealed Floor Standing	FXNQ-MAVE	●	●	●	●	●	●	●	●	●	●	●	●	●	●	●	●	●	●		
Heat Reclaim Ventilator		VAM-HVE	Airflow rate 150-2000 m³/h																			



Max. 58 indoor units

# Outside Units

## VRV IV W Series

### Specifications

Heat Pump / Heat Recovery

MODEL		RWEYQ6TYM	RWEYQ8TYM	RWEYQ10TYM	RWEYQ12TYM	RWEYQ14TYM	RWEYQ16TYM	RWEYQ18TYM	RWEYQ20TYM	RWEYQ22TYM	RWEYQ24TYM
Combination units		-	-	-	-	RWEYQ6TYM	RWEYQ8TYM	RWEYQ8TYM	RWEYQ10TYM	RWEYQ10TYM	RWEYQ12TYM
Power supply		3-phase 4-wire system, 380-415 V/380 V, 50/60 Hz				3-phase 4-wire system, 380-415 V/380 V, 50/60 Hz					
Cooling capacity	Btu/h	54,600	76,400	95,500	114,000	131,000	153,000	172,000	191,000	210,000	229,000
	kW	16.0	22.4	28.0	33.5	38.4	44.8	50.4	56.0	61.5	67.0
Heating capacity	Btu/h	61,400	85,300	107,000	128,000	147,000	171,000	193,000	215,000	235,000	256,000
	kW	18.0	25.0	31.5	37.5	43.0	50.0	56.5	63.0	69.0	75.0
Power consumption	Cooling	2.58	3.86	5.43	7.33	6.44	7.72	9.29	10.9	12.8	14.7
	Heating	2.69	3.98	5.60	7.87	6.67	7.96	9.58	11.2	13.5	15.7
Casing colour		Ivory white (5Y7.5/1)				Ivory white (5Y7.5/1)					
Dimensions (H x W x D)		1,000 x 780 x 550				(1,000 x 780 x 550) x 2					
Compressor	Type	Hermetically sealed scroll type				Hermetically sealed scroll type					
	Motor output	1.9	2.8	3.7	4.7	1.9 + 2.8	2.8 x 2	2.8 + 3.7	3.7 x 2	3.7 + 4.7	4.7 x 2
Refrigerant piping connections	Liquid	φ 9.5 (Flare)				φ 12.7 (Flare)		φ 15.9 (Flare)		φ 19.1 (Flare)	
	Suction gas *1	φ 19.1 (Brazing)		φ 22.2 (Brazing)		φ 28.6 (Brazing)		φ 28.6 (Brazing)		φ 28.6 (Brazing)	
	High and low pressure gas	φ 15.9*2, φ 19.1*3 (Brazing)		φ 19.1*2, φ 22.2*3 (Brazing)		φ 22.2*2, φ 28.6*3 (Brazing)		φ 22.2*2, φ 28.6*3 (Brazing)		φ 22.2*2, φ 28.6*3 (Brazing)	
Water piping connections	Water inlet	PT1 1/4B intenal thread				(PT1 1/4B) x 2 intenal thread					
	Water outlet	PT1 1/4B intenal thread				(PT1 1/4B) x 2 intenal thread					
	Drain outlet	PS1/2B intenal thread				(PS1/2B) x 2 intenal thread					
Machine weight (Operating weight)	kg	146 (148)		147 (149)		146 x 2 (148 x 2)		146 + 147 (148 + 149)		147 x 2 (149 x 2)	
Sound level	dB(A)	49	50	51	53	53	54	54	55	55	56
Operation range (Inlet water temp.)	°C	10 to 45				10 to 45					
Capacity control	%	23-100		19-100		23-100		20-100		19-100	
Refrigerant	Type	R-410A				R-410A					
	Charge	3.5		4.2		3.5 + 3.5		3.5 + 4.2		4.2 + 4.2	

MODEL		RWEYQ26TYM	RWEYQ28TYM	RWEYQ30TYM	RWEYQ32TYM	RWEYQ34TYM	RWEYQ36TYM
Combination units		RWEYQ8TYM	RWEYQ8TYM	RWEYQ10TYM	RWEYQ10TYM	RWEYQ10TYM	RWEYQ12TYM
Power supply		3-phase 4-wire system, 380-415 V/380 V, 50/60 Hz			3-phase 4-wire system, 380-415 V/380 V, 50/60 Hz		
Cooling capacity	Btu/h	248,000	268,000	287,000	305,000	324,000	345,000
	kW	72.8	78.4	84.0	89.5	95.0	101
Heating capacity	Btu/h	278,000	300,000	322,000	345,000	365,000	386,000
	kW	81.5	88.0	94.5	101	107	113
Power consumption	Cooling	13.2	14.7	16.3	18.2	20.1	22.0
	Heating	13.6	15.2	16.8	19.1	21.3	23.6
Casing colour		Ivory white (5Y7.5/1)			Ivory white (5Y7.5/1)		
Dimensions (H x W x D)		(1,000 x 780 x 550) x 3			(1,000 x 780 x 550) x 3		
Compressor	Type	Hermetically sealed scroll type			Hermetically sealed scroll type		
	Motor output	2.8 x 2 + 3.7	2.8 + 3.7 x 2	3.7 x 3	3.7 x 2 + 4.7	3.7 + 4.7 x 2	4.7 x 3
Refrigerant piping connections	Liquid	φ 19.1 (Flare)			φ 19.1 (Flare)		
	Suction gas *1	φ 34.9 (Brazing)			φ 34.9 (Brazing)		
	High and low pressure gas	φ 28.6*2, φ 34.9*3 (Brazing)			φ 28.6*2, φ 34.9*3 (Brazing)		
Water piping connections	Water inlet	(PT1 1/4B) x 3 intenal thread			(PT1 1/4B) x 3 intenal thread		
	Water outlet	(PT1 1/4B) x 3 intenal thread			(PT1 1/4B) x 3 intenal thread		
	Drain outlet	(PS1/2B) x 3 intenal thread			(PS1/2B) x 3 intenal thread		
Machine weight (Operating weight)	kg	146 x 2 + 147 (148 x 2 + 149)	146 + 147 x 2 (148 + 149 x 2)	147 x 3 (149 x 3)	147 x 3 (149 x 3)		
Sound level	dB(A)	55	56	56	57	57	58
Operation range (Inlet water temp.)	°C	10 to 45			10 to 45		
Capacity control	%	21-100	20-100	19-100	19-100		
Refrigerant	Type	R-410A			R-410A		
	Charge	3.5 + 3.5 + 4.2			4.2 + 4.2 + 4.2		

- Notes:
- Specifications are based on the following conditions:
    - Cooling: Indoor temp.: 27°CDB, 19°CWB / inlet water temp.: 30°C, Equivalent piping length: 7.5 m, Height difference: 0 m.
    - Heating: Indoor temp.: 20°CDB / inlet water temp.: 20°C, Equivalent piping length: 7.5 m, Height difference: 0 m.
    - Sound level: Anechoic chamber conversion value, measured at a point 1 m in front of the unit at a height of 1.5 m. During actual operation, these values are normally somewhat higher as a result of ambient conditions and oil recovery mode. When there is concern for noise to the surrounding area such as residences, we recommend investigating the installation location and taking soundproofing measures.
  - This unit cannot be installed in the outdoors. Install indoors (Machine room, etc).
  - Hold ambient temperature at 0 - 40°C and humidity at 80%RH or less. Heat rejection from the casing: 0.51 kW / 6 - 8 class / hour, 0.58 kW / 10 - 12 class / hour.
  - Connectable to closed type cooling tower only.
    - \*1: In the case of heat pump system, suction gas pipe is not used.
    - \*2: In the case of heat recovery system.
    - \*3: In the case of heat pump system.
- \* Be sure to refer to the Engineering Data Book for facility design.



# VRV WS SERIES

Water Cooled System Suitable for Residential Houses

Heat Pump  
**3 class—6 class**  
 (8 kW) (16 kW)

## Easy Installation & Energy Saving

### ■ Compact and lightweight

Footprint : **0.43 m<sup>2</sup>**

Product Weight : **90 kg**  
 (For 3 class)

Product Weight : **94 kg**  
 (For 4/5 class)

Product Weight : **99 kg**  
 (For 6 class)



### ■ Service space (Single installation)

Service access from the front with minimal space required at rear of the condenser (30 mm)

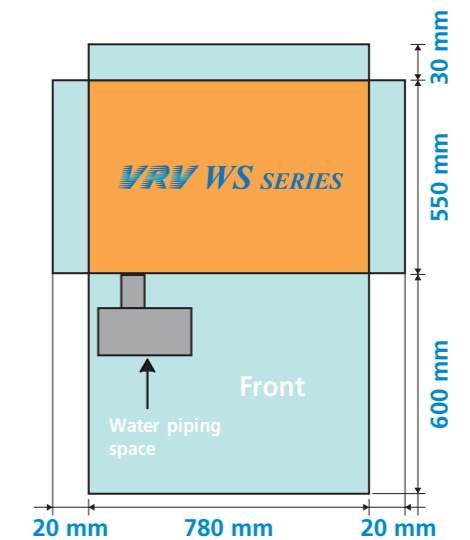

### ■ Energy saving

#### Higher Energy Efficiency Ratio (EER)

Cooling Operation EER

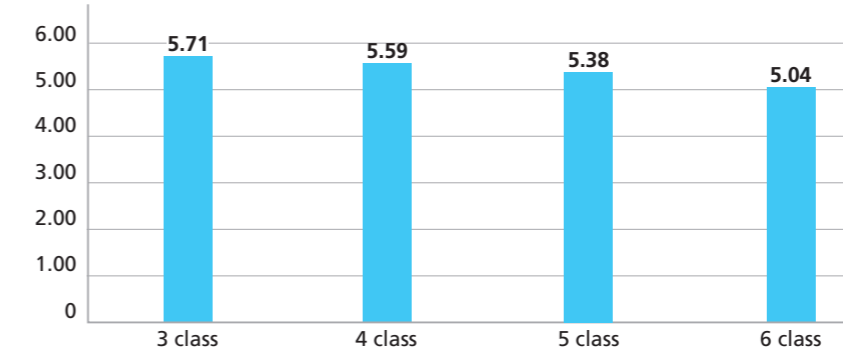

\*Cooling : Indoor temp.: 27°CDB, 19°CWB/inlet water temp.: 30°C, Equivalent piping length: 7.5 m, Height difference: 0 m.



RWXYQ3-6AV1

# Advanced Technologies

## ■ Tube-in-Tube Type Heat Exchanger

Refrigerant lines spiraling around the water circuit in a counter flow design delivers superior heat exchange.

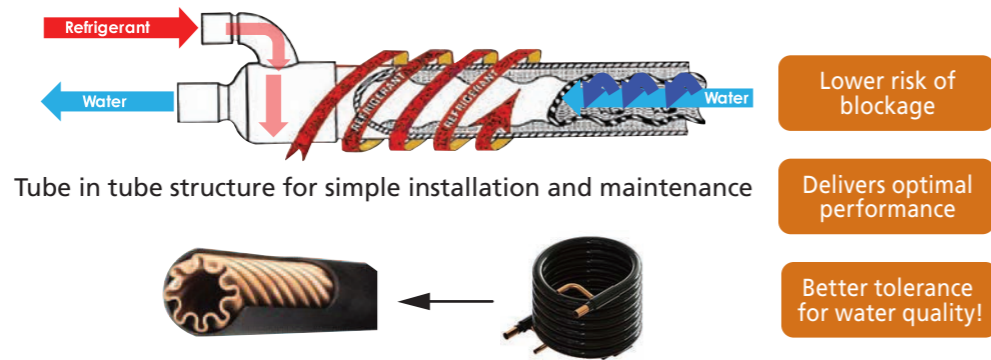

Tube in tube structure for simple installation and maintenance



Use of copper pipes enhances tolerance against corrosive effects of chloride ions

## ■ Refrigerant cooling technology

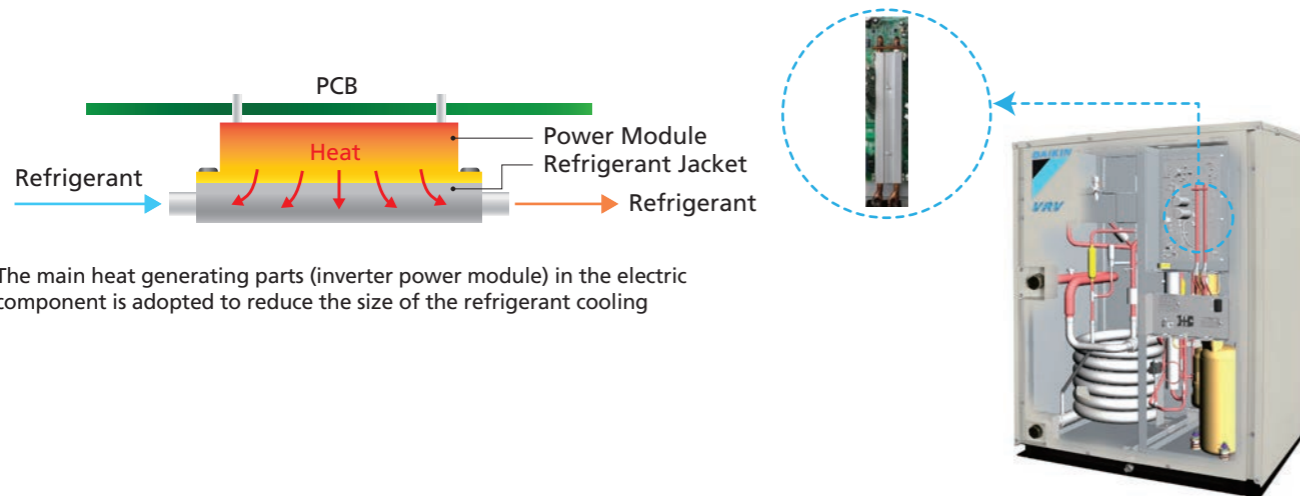

The main heat generating parts (inverter power module) in the electric component is adopted to reduce the size of the refrigerant cooling

Control board failure ratio at stable operation is reduced.

This enables

- Suitability for high ambient temperatures
- Miniaturization of electronic components

## ■ Easy maintenance

The electrical components and the major components are designed in a way that they can be accessed from front for maintenance.



## ■ Built in water flow switch

Mechanical water flow switch is built into the system to enhance system reliability.

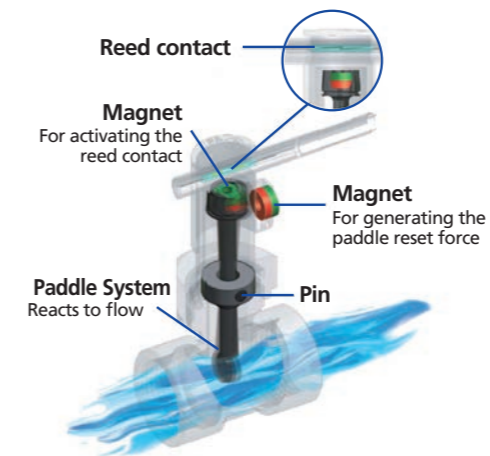

## ■ Standard water strainer

A standard water strainer is equipped so it reduces the additional cost and installation time at field.





# Flexible System Design

## Long piping length

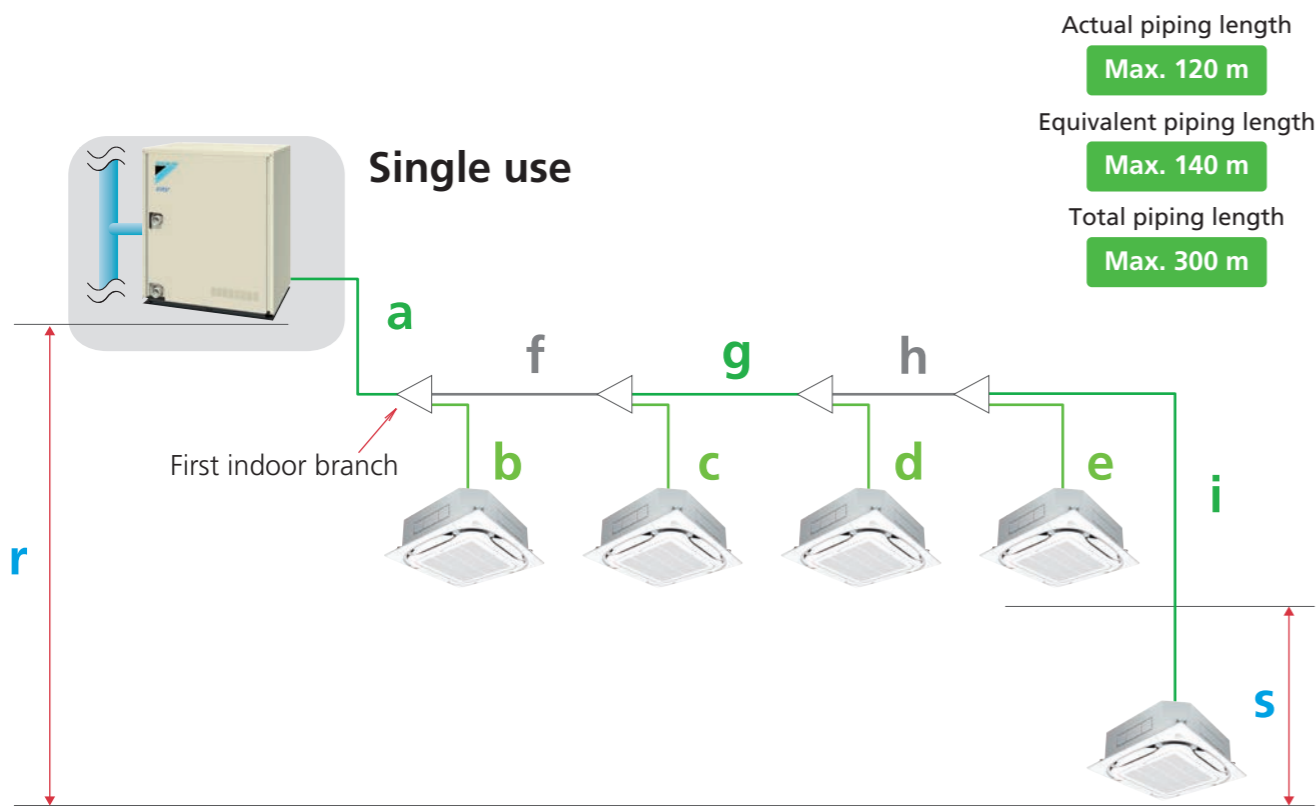

\*Colours in the diagram above are merely for identifying pipes referenced with symbols such as a.

		Actual piping length	Example	Equivalent piping length
Maximum allowable piping length	Refrigerant piping length	120 m	a+f+g+h+i	140 m
	Total piping length	300 m	a+b+c+d+e+f+g+h+i	—
	Between the first indoor branch and the farthest indoor unit	40 m	f+g+h+i	—
Maximum allowable height difference	Between the indoor units	15 m	s	—
	Between the outside units and the indoor units	30 m	r	—

# Indoor Unit Lineup

## Enhanced range of choices

Category	Type	Model Name	Capacity Range (kW)	Capacity Index																						
				20	25	32	40	50	63	71	80	100	125	140	145	160	180									
				20	25	31.25	40	50	62.5	71	80	100	125	140	145	160	180									
Ceiling Mounted Cassette	Round Flow Cassette with Sensing and Streamer	<b>New</b> FXFTQ-AVM																								
	Round Flow Cassette with Sensing	FXFSQ-AVM																								
	Round Flow Cassette	FXFQ-AVM																								
	Compact Multi Flow Cassette	<b>New</b> FXZQ-BVM																								
	Double Flow Cassette	<b>New</b> FXCQ-BVM																								
	Single Flow Cassette	FXEQ-AV36																								
Ceiling Concealed Duct	Slim Duct (Standard)	FXDQ-PDVE																								
		FXDQ-NDVE																								
	Slim Duct (Compact)	FXDQ-TV1C(A)																								
	Middle Static Pressure Duct	FXSQ-PAVE																								
		FXDYQ-MAV1																								
	Middle-High Static Pressure Duct	FXMQ-PAVE																								
High Static Pressure Duct	FXMQ-PV1A																									
Ceiling Suspended	4-Way Flow Ceiling Suspended	FXUQ-AVEB																								
	Ceiling Suspended	<b>New</b> FXHQ-MAVE																								
Floor Standing	Wall Mounted	FXAQ-AVM																								
	Floor Standing	FXLQ-MAVE																								
	Concealed Floor Standing	FXNQ-MAVE																								

# Outside Units

## VRV WS Series

### Specifications

Heat Pump



MODEL		RWXYQ3AV1	RWXYQ4AV1	RWXYQ5AV1	RWXYQ6AV1	
Power supply		1-Phase, 220-240 V, 50 Hz				
Cooling capacity	Btu/h	27,300	38,200	47,800	54,600	
	kW	8.0	11.2	14.0	16.0	
Heating capacity	Btu/h	30,700	42,700	54,600	61,400	
	kW	9.0	12.5	16.0	18.0	
Power consumption	Cooling	kW	1.40	2.00	2.60	3.17
	Heating	kW	1.60	2.10	2.60	2.80
Casing colour		Ivory white (5Y7.5/1)				
Dimensions (HxWxD)		mm 1,000x780x550				
Compressor	Type	Hermetically sealed swing type				
	Motor output	kW 1.92				
Refrigerant piping connections	Liquid	mm $\phi$ 9.5 (Flare)				
	Suction gas	mm $\phi$ 15.9 (Flare)				
Water piping connections	Water inlet	PT1B external thread		PT1 1/4B external thread		
	Water outlet	PT1B external thread		PT1 1/4B external thread		
	Drain outlet	PS1/2B internal thread				
Machine weight	kg	90	94	99		
Sound level	dB(A)	48	50			
Sound power	dB(A)	66	68			
Operation range (Inlet water temp.)	°C	15 to 45 (Range for continuous operation)				
Capacity control	%	20-100				
Refrigerant	Type	R-410A				
	Charge	kg	2.2	2.4	2.7	
Rated water flow (Range of water flow)	L/min	30 (15 to 45)	40 (20 to 60)	50 (25 to 75)	57 (28.5 to 85.5)	

Note :1. Specifications are based on the following conditions ;  
 ·Cooling : Indoor temp. : 27°CDB, 19°CWB / inlet water temp. :30°C, Equivalent piping length : 7.5 m, Height difference : 0 m.  
 ·Heating : Indoor temp. : 20°CDB / inlet water temp. : 20°C, Equivalent piping length : 7.5 m, Height difference : 0 m.  
 ·Sound level: Anechoic chamber conversion value, measured at a point 1 m in front of the unit at a height of 1.5 m.  
 During actual operation, these values are normally somewhat higher as a result of ambient conditions and oil recovery mode.  
 When there is concern for noise to the surrounding area such as residences, we recommend investigating the installation location and taking soundproofing measures.  
 2. This unit cannot be installed in the outdoors. Install indoors (Machine room, etc).  
 3. Hold ambient temperature at 0-40°C and humidity at 80% RH or less.  
 Heat rejection from the casing: 0.21 kW/3 class /hour, 0.28 kW/4 class /hour, 0.31 kW/5 class /hour, 0.35 kW/6 class /hour

### Outside Unit Combinations

Model name	kW	class	Capacity index	Total capacity index of connectable indoor units			Maximum number of connectable indoor units
				Combination (%)			
				50%	100%	130%	
<b>RWXYQ3A</b>	8.0	3	75	37.5	75	97.5	4
<b>RWXYQ4A</b>	11.2	4	100	50	100	130	6
<b>RWXYQ5A</b>	14.0	5	125	62.5	125	162.5	8
<b>RWXYQ6A</b>	16.0	6	150	75	150	195	9

















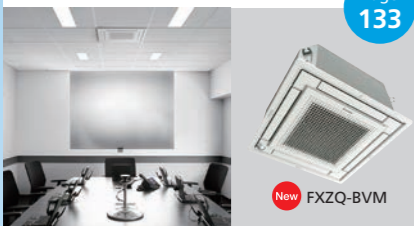



Note: Total capacity index of connectable indoor units must be 50%–130% of the capacity index of the outside unit.



# INDOOR UNIT LINEUP

Daikin offers a wide range of indoor units responding to variety of needs of our customers that require air-conditioning solutions.

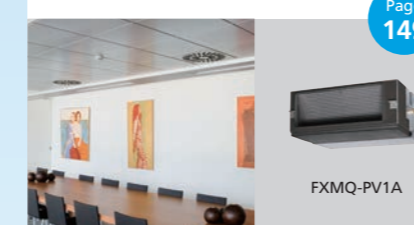
## VRV indoor units

<p><b>Round Flow Cassette with Sensing and Streamer Type</b></p> <p>Comfort, energy savings by sensing functions and enhanced maximum efficiency in cleaning</p> <p>Page 117</p>  <p>FXFTQ-AVM</p>	<p><b>Round Flow Cassette with Sensing Type</b></p> <p>Comfort and energy savings by sensing functions</p> <p>Page 123</p>  <p>FXFSQ-AVM</p>	<p><b>Round Flow Cassette Type</b></p> <p>360° airflow for improved comfort</p> <p>Page 129</p>  <p>FXFQ-AVM</p>	<p><b>Outdoor-Air Processing Unit</b></p> <p>Combine fresh air treatment and air conditioning, supplied from a single system.</p> <p>Page 167</p>  <p>FXMQ-MFV1</p>	<p><b>Outdoor-Air Processing Unit</b></p> <p>Improve IAQ with fresh air ventilation and precise room temperature control</p> <p>Page 169</p>  <p>FXMQ-AFVM</p>	<p><b>4-Way Flow Ceiling Suspended Type</b></p> <p>Slim and stylish design, optimum air distribution, installation without ceiling cavity</p> <p>Page 151</p>  <p>FXUQ-AVEB</p>
<p><b>Compact Multi Flow Cassette Type</b></p> <p>Quiet, compact, and designed for user comfort</p> <p>Page 133</p>  <p>FXZQ-BVM</p>	<p><b>Double Flow Cassette Type</b></p> <p>Thin, lightweight, and easy to install in narrow ceiling spaces</p> <p>Page 135</p>  <p>FXCQ-BVM</p>	<p><b>Single Flow Cassette Type</b></p> <p>Slim design for flexible installation</p> <p>Page 137</p>  <p>FXEQ-AV36</p>	<p><b>Ceiling Suspended Type</b></p> <p>Slim body with quiet and wide airflow.</p> <p>Page 153</p>  <p>FXHQ-MAVE FXHQ-BVM</p>	<p><b>Wall Mounted Type</b></p> <p>Stylish flat panel design harmonised with your interior décor.</p> <p>Page 155</p>  <p>FXAQ-AVM</p>	<p><b>Floor Standing Type</b></p> <p>Suitable for perimeter zone air conditioning</p> <p>Page 157</p>  <p>FXLQ-MAVE</p>
<p><b>Slim Duct (Standard) Type</b></p> <p>Slim design, quietness and ideal for drop-ceilings</p> <p>Page 139</p>  <p>FXDQ-PDVE FXDQ-NDVE</p>	<p><b>Slim Duct (Compact) Type</b></p> <p>Slim and compact design for easy and flexible installation</p> <p>Page 141</p>  <p>FXDQ-TV1C(A)</p>	<p><b>Middle Static Pressure Duct Type</b></p> <p>Middle static pressure and slim design allow flexible installations.</p> <p>Page 143</p>  <p>FXSQ-PAVE</p>	<p><b>Concealed Floor Standing Type</b></p> <p>Suitable for perimeter zone air conditioning</p> <p>Page 158</p>  <p>FXNQ-MAVE</p>	<p><b>Air Handling Unit</b></p> <p>Integrate your air handling unit in a total solution for large size spaces such as factories and large stores.</p> <p>Page 163</p>  <p>AHUR</p>	
<p><b>Middle Static Pressure Duct Type</b></p> <p>Middle static pressure and slim design allow flexible installations.</p> <p>Page 145</p>  <p>FXDYQ-MAV1</p>	<p><b>Middle-High Static Pressure Duct Type</b></p> <p>Middle and high static pressure allows for flexible duct design.</p> <p>Page 147</p>  <p>FXMQ-PAVE</p>	<p><b>High Static Pressure Duct Type</b></p> <p>High static pressure allows for flexible duct design.</p> <p>Page 149</p>  <p>FXMQ-PV1A</p>	<p><b>Air treatment equipment</b></p> <p><b>Heat Reclaim Ventilator</b></p> <p>Daikin VAM series ensures fresh air intake and energy savings</p> <p>Page 173</p>  <p>VAM-HVE</p>		

# Round Flow Cassette with Sensing and Streamer Type

New FXFTQ-A

Comfort, energy savings by sensing functions and enhanced maximum efficiency in cleaning



## Introducing Streamer technology to VRV Indoor unit

Daikin Streamer Technology enhances maximum efficiency in cleaning, which uses powerful decomposition properties to decompose substances captured by filter for better air quality.

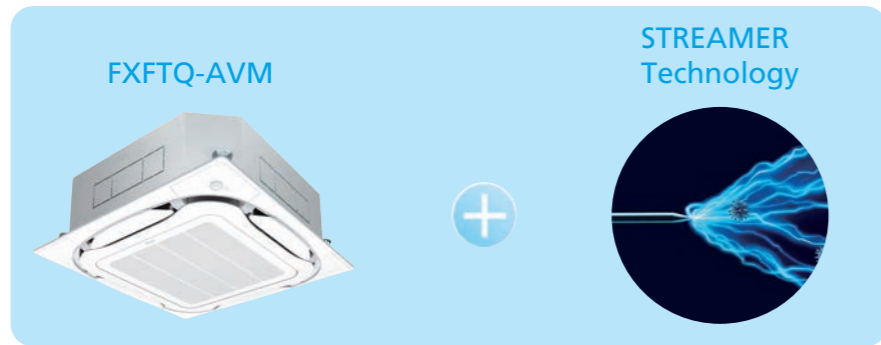

Streamer filter clean unit irradiates Streamer when the fan and air conditioning operation are stopped. Streamer fumigates the cabin and sterilizes the filter.

New Streamer filter clean unit built-in inside the indoor unit

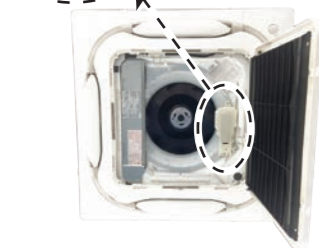

### Remarks:

- 1) Only the remote controller BRC1H63W(K) can be connected for ON/OFF operation of the streamer.
- 2) The Streamer function operates only when the fan and air conditioning operation are stopped. The maximum operation of streamer is 180 minutes per day. (This function is available only when the remote controller BRC1H63W(K) is connected.)



Stylish Remote Controller BRC1H63W/K



Streamer ON/OFF setting and status icon are available.



## Streamer Technology

Equipped with decomposition technology, Streamer is a type of plasma discharge that eliminates allergens such as pollen, mould, and mites, as well as, deodorises anti-bacterial dust filters so you can breathe with ease.

### Mechanism of decomposition by Streamer

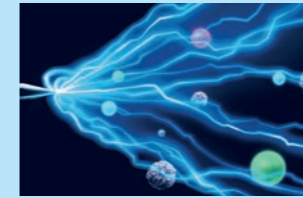

Streamer emits high-speed electrons.

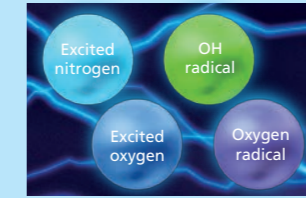

The electrons collide and combine with nitrogen and oxygen in the air to form four kinds of decomposing elements with decomposition power.

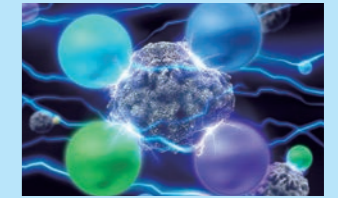

The decomposing elements provide decomposition power.

### 99.93% Inactivation of Omicron variant in 2 hours

#### Experimental Results

Irradiation with Streamer discharge for two hours inactivated 99.93%, and for four hours inactivated 99.97% of the Omicron variant of Coronavirus (SARS-CoV-2), when compared to without Streamer discharge.

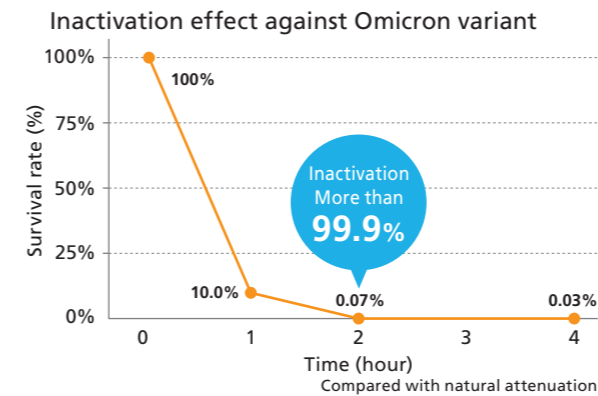

#### Test Method

hCoV-19/Japan/ TY38-873/2021 strain (Omicron variant) was used. Two acrylic boxes of about 31L were placed in a safety cabinet in the BSL-3 facility, and Streamer discharge device was installed in one of the acrylic boxes. Seesaw shakers with a 6-well plate were placed in both boxes, and 0.5 mL of virus solution was placed in each well of the plate. Streamer irradiation was performed on one 6-well plate while stirring with a seesaw shaker. After 1, 2, and 4 hours, the virus solution was collected, and the virus titer was measured by the TCID50 method using Vero E6/TMPRSS2 cells.



#### Test Organization

Professor Tatsuo Shioda, Department of Virus Infections, Research Institute for Microbial Diseases, Osaka University

\*This result was obtained by using a Streamer discharge device for testing in lab conditions. The effect of products equipped with Streamer technology or results in actual use environments may differ.

### Streamer decomposes mould and mites (feces and carcasses) and suppresses the causes of allergies.

#### Demonstration of mould

Picture of mould

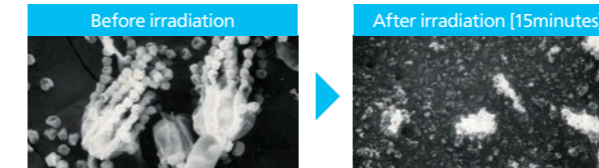

#### Test Method

"Moulds" were placed on the electrodes of a Streamer discharge unit where they were exposed to Streamer discharge for 15 minutes and photographed with an electron microscope.

#### Test Organization

Demonstration test was performed at Wakayama Medical University.

### Why Daikin Streamer?

Recognized as clean technology by public bodies

Winner of the 2005 Progress Award, Institute of Electrostatics Japan  
Awarded for the development of a domestic air purifier which uses DC Streamer discharge.

105 Patents Acquired  
Patents acquired relating to Streamer technology

Streamer, a type of plasma discharge, decomposes hazardous chemical substances. The decomposition power is comparable to thermal energy of about 100,000°C.\*

Note:  
\*Comparison of oxidation decomposition. This does not mean temperature will become high.

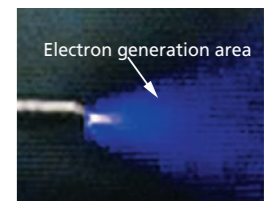



# Round Flow Cassette with Sensing and Streamer Type

## Daikin advanced sensing technology dual sensors

Comfort and energy saving by sensing functions

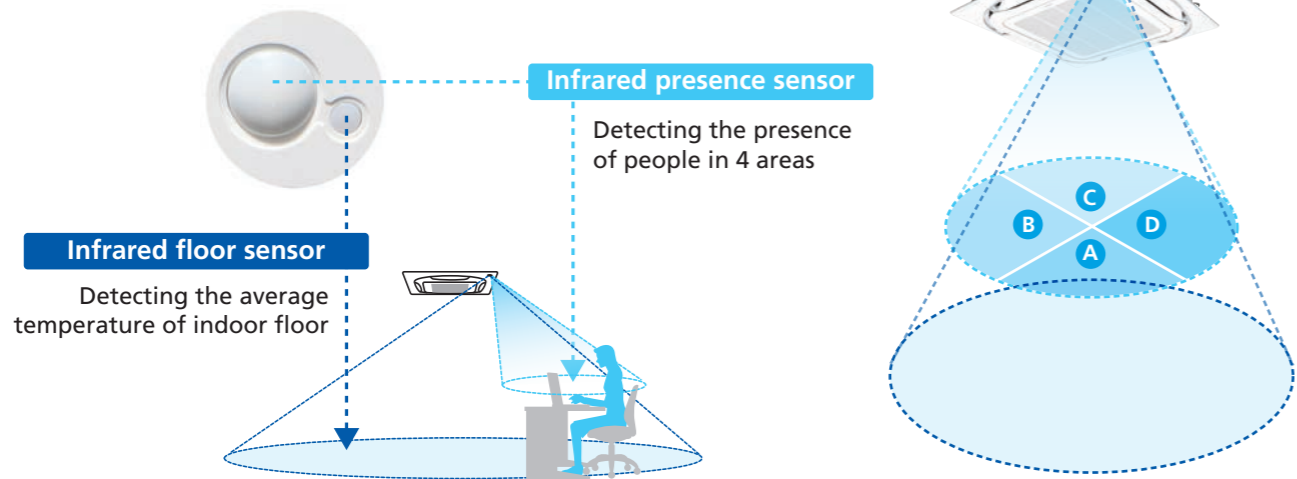

### Sensing sensor mode Energy saving

#### Sensing sensor low mode (default: OFF)

When there are no people in a room, the set temperature is shifted automatically.

- Example**
- Cooling setpoint: 26°C
  - Shift temperature: 1.0°C
  - Shift time: 30 min.
  - Limit cooling temperature: 30°C

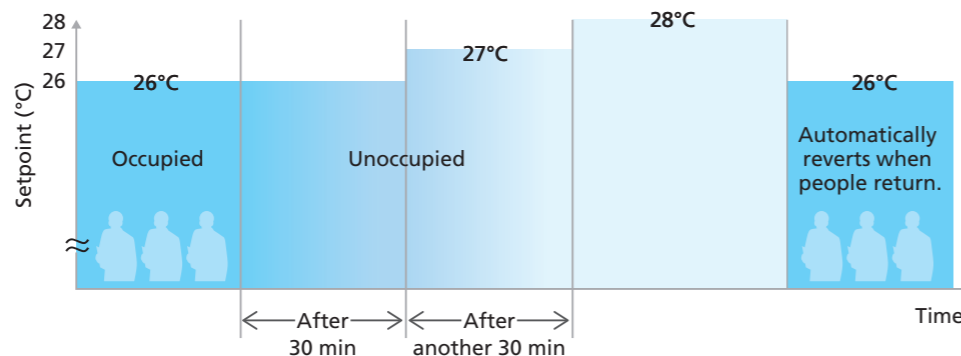

#### Sensing sensor stop mode (default: OFF)

Based on preset user conditions, the system automatically stops operation if the room is unoccupied.

\*Adjustment is possible for shift time and set temperature by local setting.

## Individual airflow direction control

### Comfortable air conditioning for all room layouts and conditions

Easy setting is possible with a wired remote controller

Airflow direction can be individually adjusted for each air discharge outlet to deliver optimal air distribution.

- Individual airflow settings**
- No individual setting (Auto airflow)
  - Position 0 (Highest point)
  - Position 1
  - Position 2
  - Position 3
  - Position 4 (Lowest point)
  - Swing

Individual settings are possible as stated above.

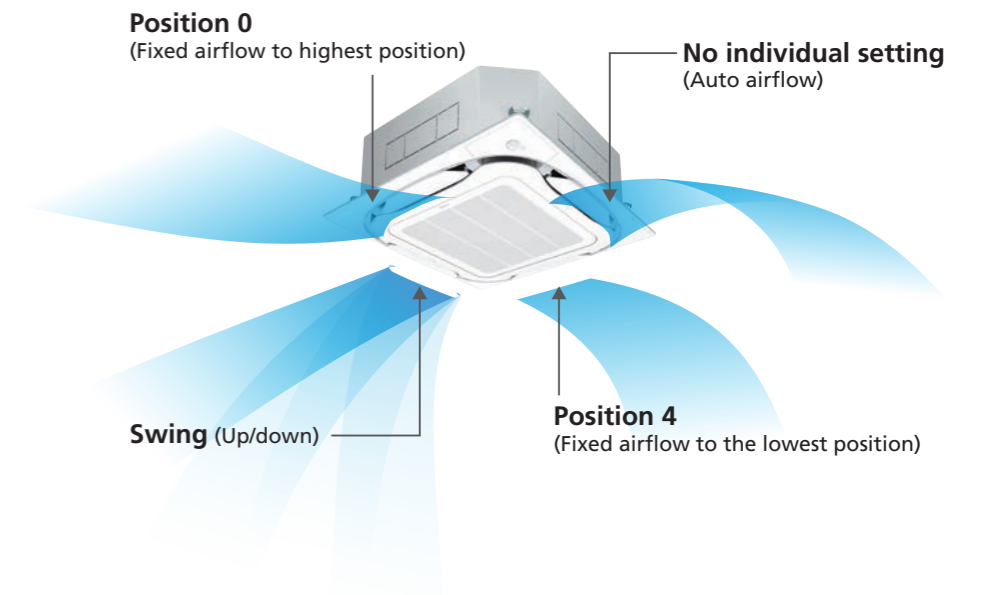

Comfort is provided to the entire room by individual setting corresponding to 4-way flow conditions.

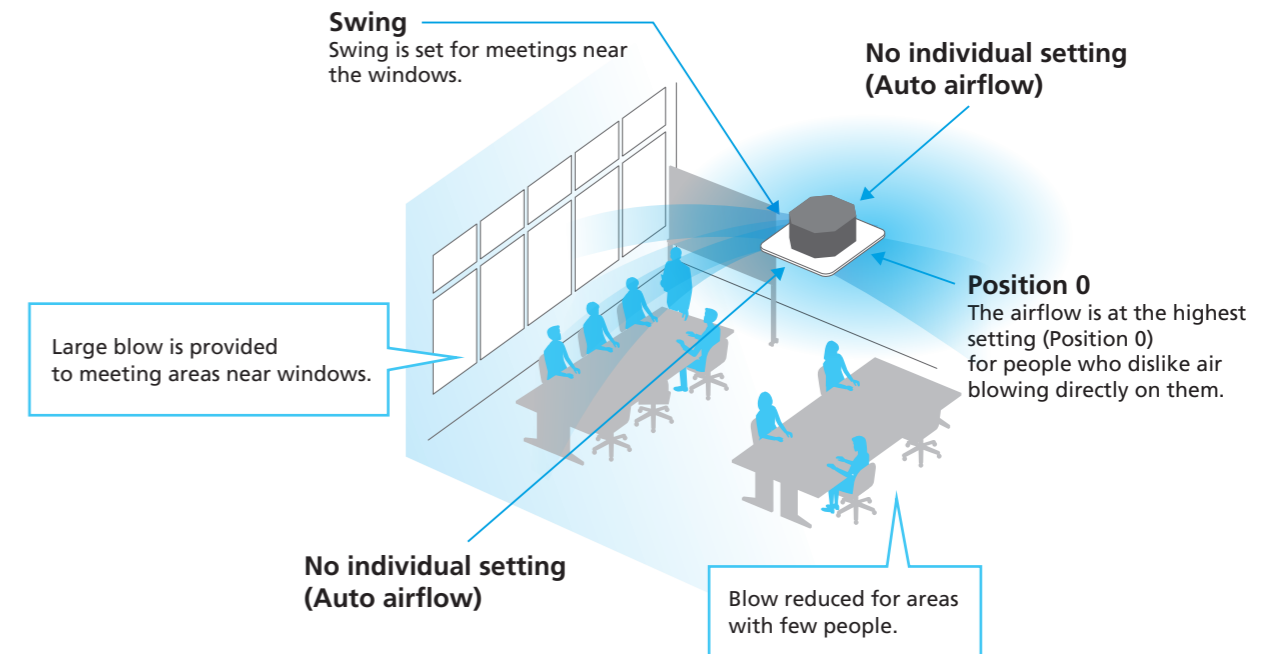

# Round Flow Cassette with Sensing and Streamer Type

## Other functions

### Quick and easy installation

Installable in tight ceiling spaces

Min. of 261 mm\* ceiling space when using standard panel.

\* For FXFTQ25-80A models.

Drain pump is equipped as standard accessory with 850 mm lift.

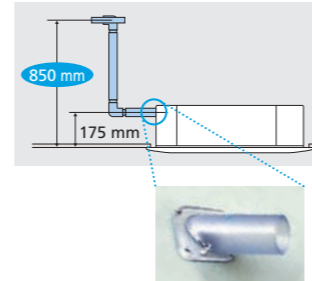

### Easy maintenance

Drain pan and drain water check

The condition of the drain pan and drain water can be checked by removing the suction grille and drain plug.

Just open the suction grille!

Drain outlet (with rubber plug)

Note: For inquiries concerning auto grille panel installations, please contact your local dealer or Daikin representative.

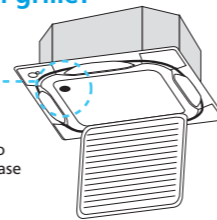

### Cleanliness

Silver ion anti-bacterial drain pan

Prevents the growth of slime, bacteria, and mould that cause odours and clogging.

\* Drain pan should be changed once every two to three years.



Filter has anti-mould and antibacterial treatment

High Performance Prefilter (MERV 8) (Option) See page 209

This filter can catch more harmful substances in the air such as PM2.5.

BAF552A160



### Panel (Option)



Standard panel with sensing  
BYCQ125EEF (Fresh White)



Standard panel with sensing  
BYCQ125EEK (Black)

### Specifications

MODEL		FXFTQ25AVM	FXFTQ32AVM	FXFTQ40AVM	FXFTQ50AVM	FXFTQ63AVM	FXFTQ80AVM	FXFTQ100AVM	FXFTQ125AVM	FXFTQ140AVM	
Power supply		1-phase, 220-240 V/220-230 V, 50/60 Hz									
Cooling capacity	Btu/h	9,600	12,300	15,400	19,100	24,200	30,700	38,200	47,800	54,600	
	kW	2.8	3.6	4.5	5.6	7.1	9.0	11.2	14.0	16.0	
Heating capacity	Btu/h	10,900	13,600	17,100	21,500	27,300	34,100	42,700	54,600		
	kW	3.2	4.0	5.0	6.3	8.0	10.0	12.5	16.0		
Power consumption	Cooling	0.028		0.035	0.056	0.061	0.092	0.164	0.170	0.194	
	Heating	0.026		0.034	0.056	0.060	0.092	0.144	0.159	0.183	
Casing		Galvanised steel plate									
Airflow rate (H/HM/M/ML/L)	ℓ/s	217/208/192/183/167		283/225/208/200/183	383/342/317/242/183	392/350/333/267/225	408/367/342/333/250	558/508/450/392/350	575/525/475/425/383	592/542/492/442/383	
	m <sup>3</sup> /min	13/12.5/11.5/11/10		17/13.5/12.5/12/11	23/20.5/19/14.5/11	23.5/21/20/16/13.5	24.5/22/20.5/20/15	33.5/30.5/27/23.5/21	34.5/31.5/28.5/25.5/23	35.5/32.5/29.5/26.5/23	
Sound level (H/HM/M/ML/L)	dB(A)	30/29.5/28.5/28/27		35/29.5/29/28/27	38/35/34.5/29.5/27	38/36/35.5/31.5/28	39/37/36/35.5/31	44/41/38/35/33	45/42.5/39.5/37/35	46/43.5/40.5/38/35	
Dimensions (HxWxD)	mm	256x840x840							298x840x840		
Machine weight	kg	19			24	22		25		26	
Piping connections	Liquid (Flare)	∅ 6.4				∅ 9.5					
	Gas (Flare)	∅ 12.7				∅ 15.9					
	Drain	VP25 (External Dia. 32/Internal Dia. 25)									

Notes: Specifications are based on the following conditions;

- Cooling: Indoor temp.: 27°CDB, 19°CWB, Outdoor temp.: 35°CDB, Equivalent piping length: 7.5 m, Height difference: 0 m.
- Heating: Indoor temp.: 20°CDB, Outdoor temp.: 7°CDB, 6°CWB, Equivalent piping length: 7.5 m, Height difference: 0 m.
- Capacity of indoor unit is only for reference. Actual capacity of indoor unit is based on the total capacity index. (See Engineering Data Book for details.)
- Sound level: Anechoic chamber conversion value, measured at a point 1.5 m downward from the unit centre. During actual operation, these values are normally somewhat higher as a result of ambient conditions.

### Panel (Option)

Standard panel with sensing	Model	BYCQ125EEF (Fresh White)	
	Dimensions(HxWxD)	mm	50x950x950
	Weight	kg	5.5
	Model	BYCQ125EEK (Black)	
	Dimensions(HxWxD)	mm	50x950x950
	Weight	kg	5.5

### Function List

Wired remote controller	BRC1H63W(K)
Streamer function unit	○
Dual sensors *1	○
Auto airflow function (Draft prevention) *1	○
Sensing sensor low mode *1	○
Sensing sensor stop mode *1	○
Individual airflow direction control	○
Switchable 5 step fan speed	○
Auto airflow rate	○
Auto swing	○
High ceiling application	○

\*1. Applicable when sensing panel is installed.



# Round Flow Cassette with Sensing Type

FXFSQ-A

Comfort and energy saving by sensing functions



## Daikin advanced sensing technology dual sensors

Comfort and energy saving by sensing functions

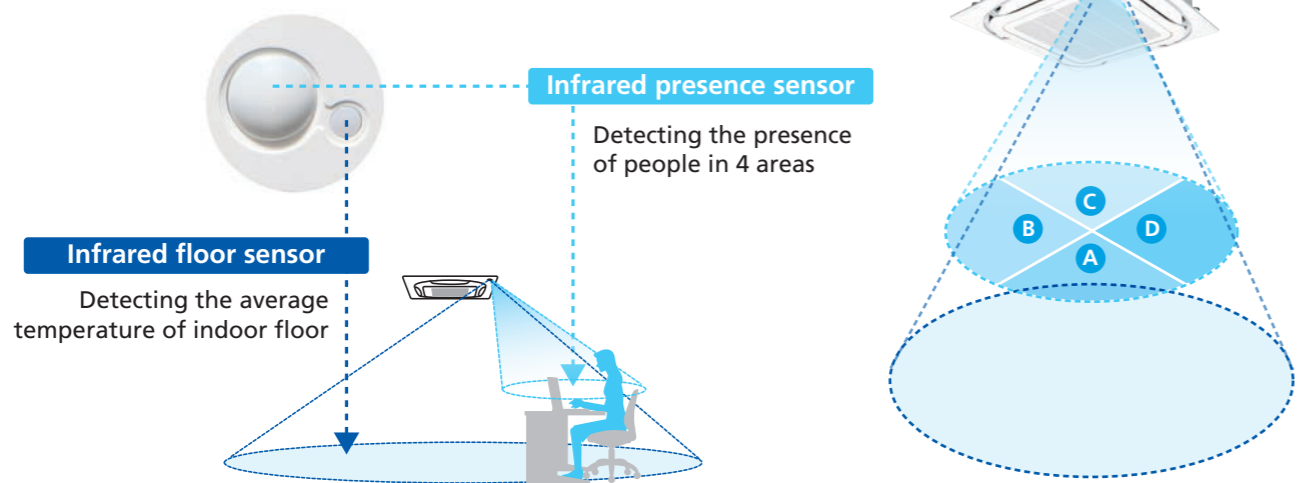

### Comfort and energy saving preventing over cooling/heating

Sensors detecting human presence and temperatures near the floor provide comfortable spaces without uneven temperatures.

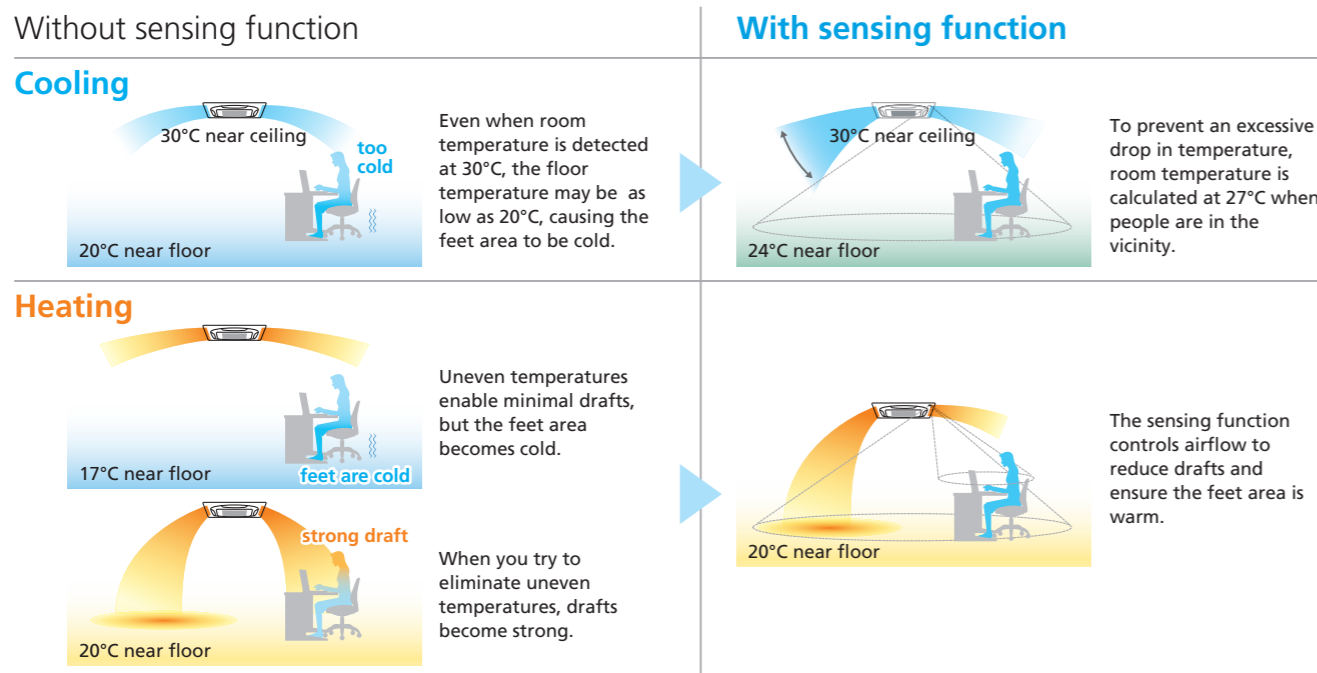

### Auto airflow function

\*When human is not detected for 5 minutes, the unit automatically returns to controlling the flaps for an unoccupied room.

#### Direct Airflow (default: OFF)

Cooling Dry

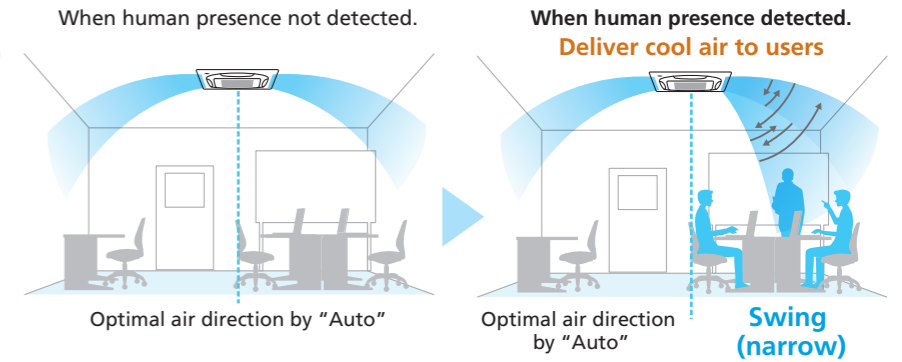

#### Draft prevention function (default: OFF)

Heating

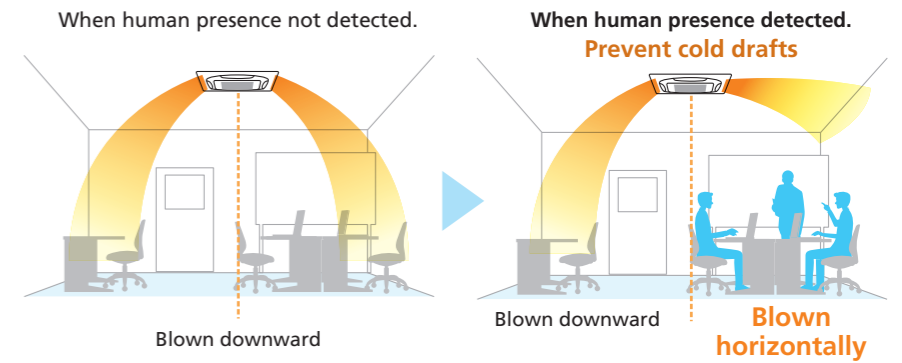

### Sensing sensor mode

#### Sensing sensor low mode (default: OFF)

When there are no people in a room, the set temperature is shifted automatically.

Example

- Cooling setpoint: 26°C
- Shift temperature: 1.0°C
- Shift time: 30 min.
- Limit cooling temperature: 30°C

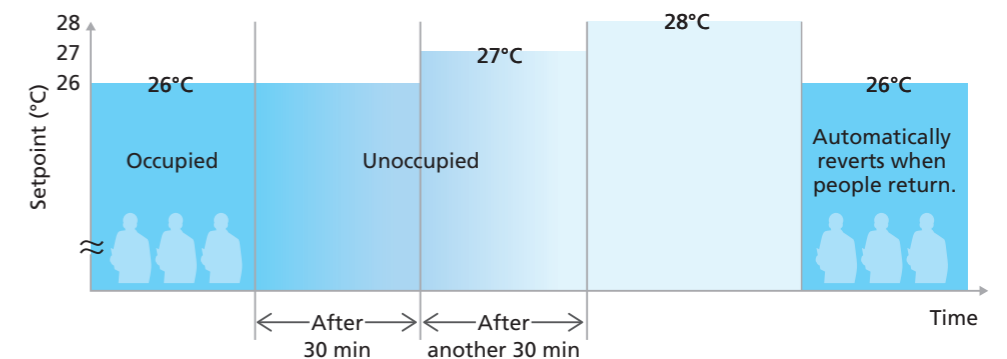

#### Sensing sensor stop mode (default: OFF)

Based on preset user conditions, the system automatically stops operation if the room is unoccupied.

\*Adjustment is possible for shift time and set temperature by local setting.

# Round Flow Cassette with Sensing Type

## Circulation airflow\*1

### Configurations of circulation airflow

Circulation airflow cools the entire room to deliver comfort that never feels cold.

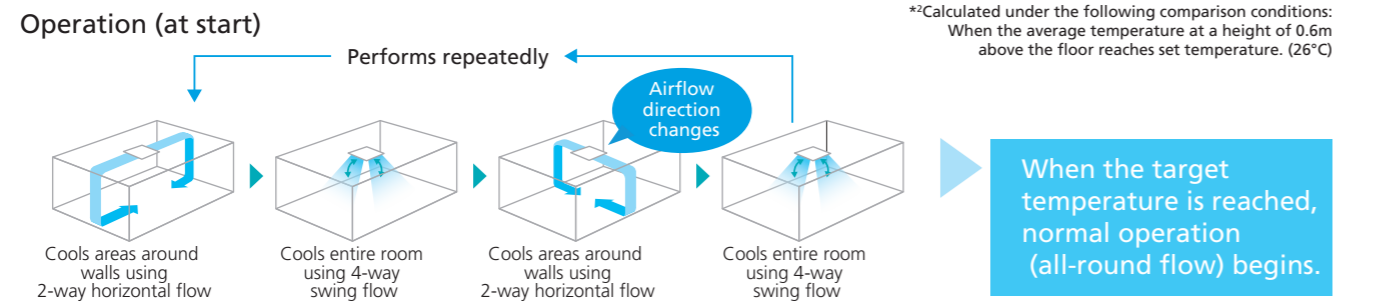
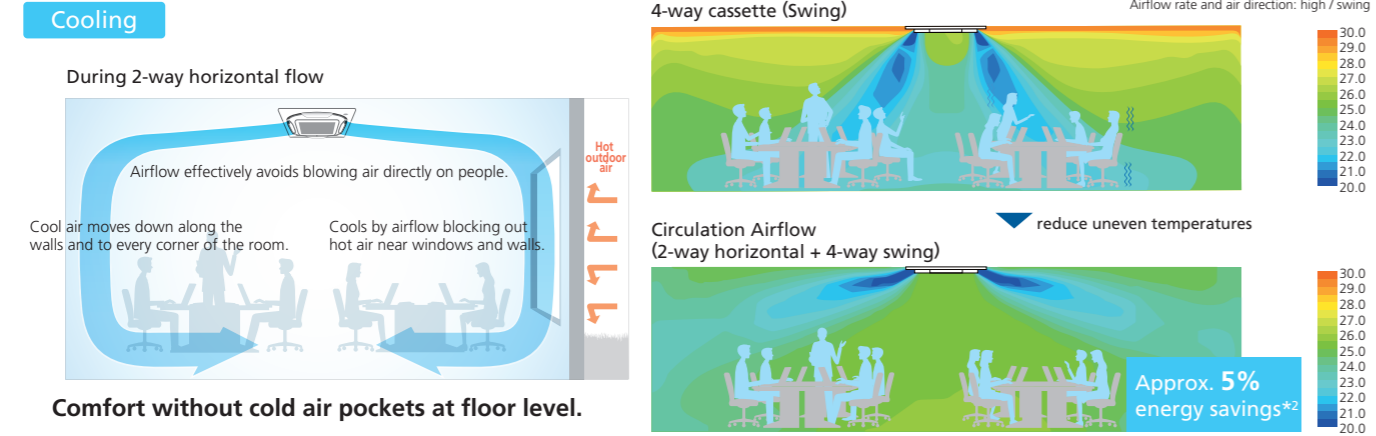

Circulation airflow warms the entire room starting from your feet.

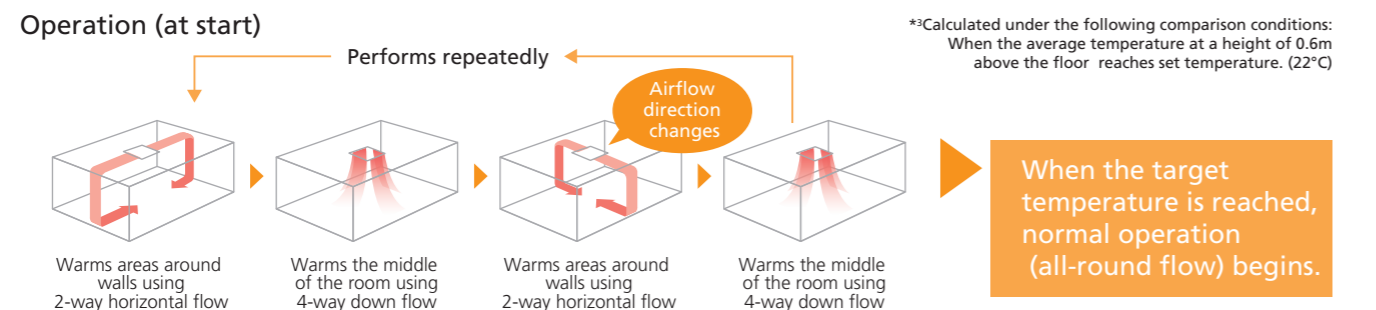
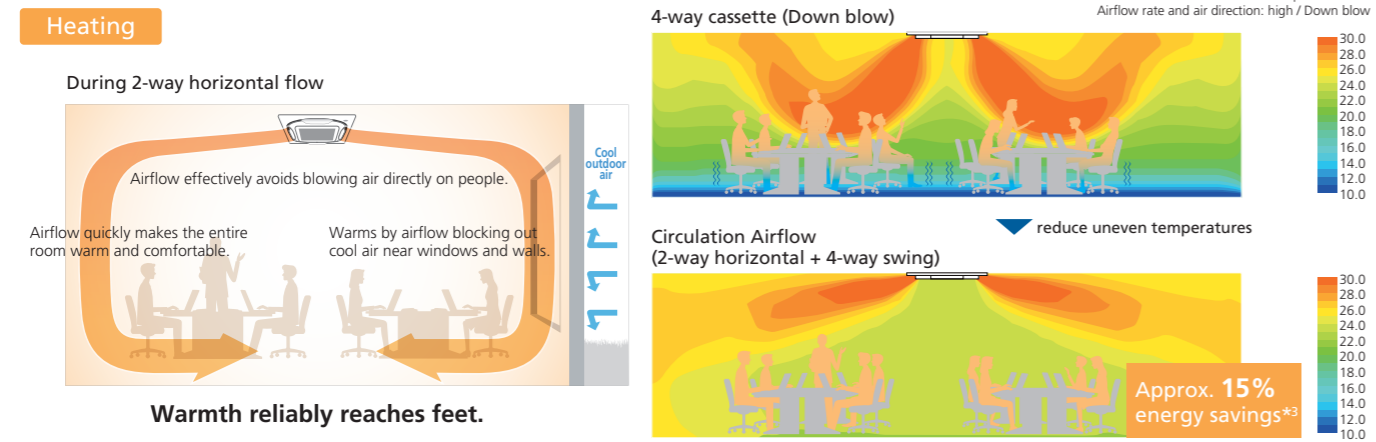

## Individual airflow direction control

\* Applicable when wired remote controller BRC1E63 or BRC1H63W(K) is used.

### Comfortable air conditioning for all room layouts and conditions

Easy setting is possible with a wired remote controller

Airflow direction can be individually adjusted for each air discharge outlet to deliver optimal air distribution.

- Individual airflow settings**
- No individual setting (Auto airflow)
  - Position 0 (Highest point)
  - Position 1
  - Position 2
  - Position 3
  - Position 4 (Lowest point)
  - Swing

Individual settings are possible as stated above.

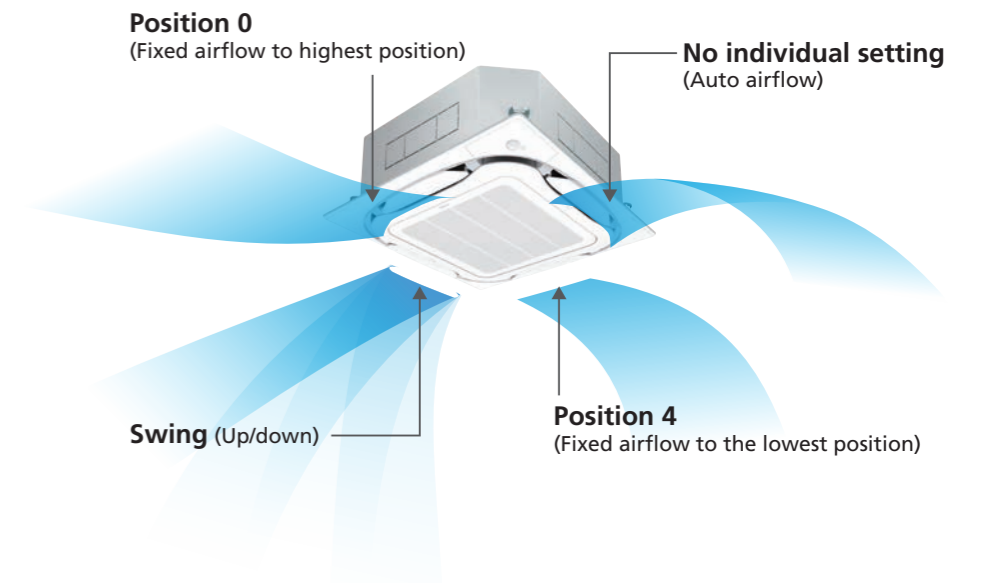

Comfort is provided to the entire room by individual setting corresponding to 4-way flow conditions.

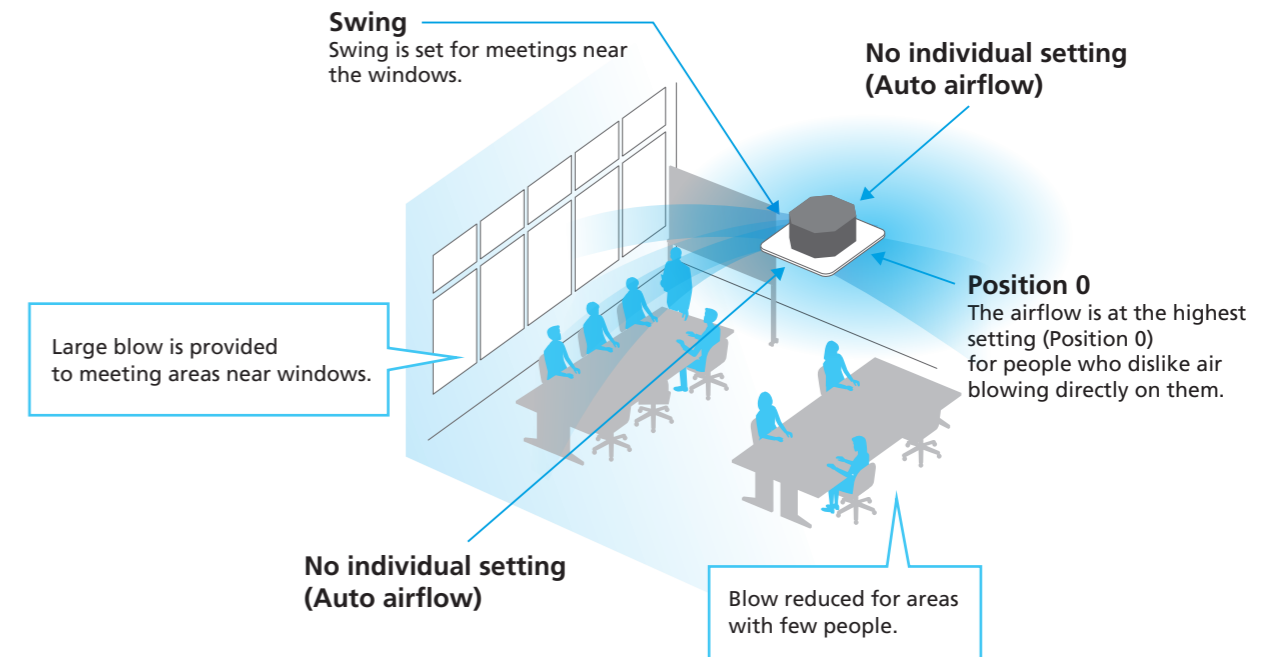



# Round Flow Cassette with Sensing Type

## Other functions

### Comfort

From All-round flow to 2-way flow, various airflow patterns available.

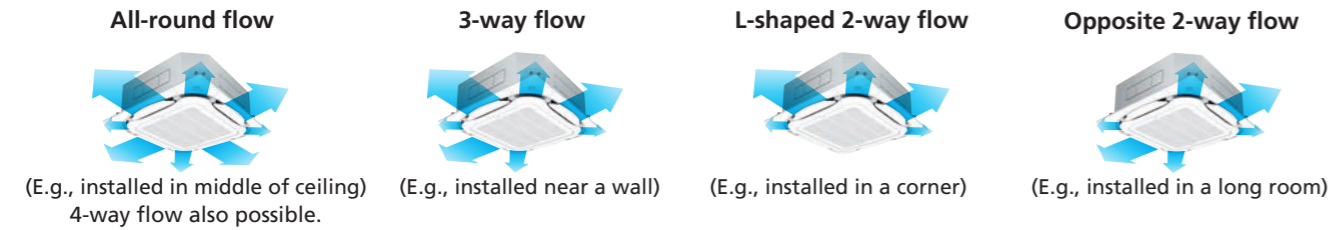

\* Whatever the discharge direction, the same type of panel is used. If installing for other than all-round flow, an air discharge outlet sealing material (option) must be used to close each unused outlet.

### Suitable for high ceilings

Even in spaces with high ceilings, a comfortable airflow is carried down to the floor level.

### Quick and easy installation

#### Installable in tight ceiling spaces

Min. of 261 mm\* ceiling space when using standard panel.

\* For FXFSQ25-80A models.

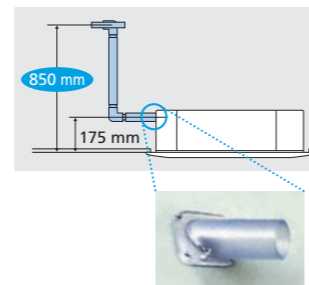

Drain pump is equipped as standard accessory with 850 mm lift.

### Easy maintenance

#### Drain pan and drain water check

The condition of the drain pan and drain water can be checked by removing the suction grille and drain plug.

Just open the suction grille!

Drain outlet (with rubber plug)

Note: For inquiries concerning auto grille panel installations, please contact your local dealer or Daikin representative.

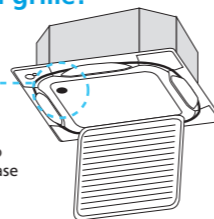

### Cleanliness

#### Silver ion anti-bacterial drain pan

Prevents the growth of slime, bacteria, and mould that cause odours and clogging.

\* Drain pan should be changed once every two to three years.

#### Filter has anti-mould and antibacterial treatment

#### High Performance Prefilter (MERV 8) (Option) See page 209

This filter can catch more harmful substances in the air such as PM2.5.



BAF552A160



### Panel (Option)



Standard panel with sensing  
BYCQ125EEF (Fresh White)



Standard panel with sensing  
BYCQ125EEK (Black)

### Specifications

MODEL		FXFSQ25AVM	FXFSQ32AVM	FXFSQ40AVM	FXFSQ50AVM	FXFSQ63AVM	FXFSQ80AVM	FXFSQ100AVM	FXFSQ125AVM	FXFSQ140AVM
Power supply		1-phase, 220-240 V/220-230 V, 50/60 Hz								
Cooling capacity	Btu/h	9,600	12,300	15,400	19,100	24,200	30,700	38,200	47,800	54,600
	kW	2.8	3.6	4.5	5.6	7.1	9.0	11.2	14.0	16.0
Heating capacity	Btu/h	10,900	13,600	17,100	21,500	27,300	34,100	42,700	54,600	
	kW	3.2	4.0	5.0	6.3	8.0	10.0	12.5	16.0	
Power consumption	Cooling	0.028		0.035	0.056	0.061	0.092	0.164	0.170	0.194
	Heating	0.026		0.034	0.056	0.060	0.092	0.144	0.159	0.183
Casing		Galvanised steel plate								
Airflow rate (H/HM/M/ML/L)	ℓ/s	217/208/192/183/167		283/225/208/200/183	383/342/317/242/183	392/350/333/267/225	408/367/342/333/250	558/508/450/392/350	575/525/475/425/383	592/542/492/442/383
	m <sup>3</sup> /min	13/12.5/11.5/11/10		17/13.5/12.5/12/11	23/20.5/19/14.5/11	23.5/21/20/16/13.5	24.5/22/20.5/20/15	33.5/30.5/27/23.5/21	34.5/31.5/28.5/25.5/23	35.5/32.5/29.5/26.5/23
Sound level (H/HM/M/ML/L)	dB(A)	30/29.5/28.5/28/27		35/29.5/29/28/27	38/35/34.5/29.5/27	38/36/35.5/31.5/28	39/37/36/35.5/31	44/41/38/35/33	45/42.5/39.5/37/35	46/43.5/40.5/38/35
Dimensions (HxWxD)	mm	256x840x840						298x840x840		
Machine weight	kg	19			24	22		25	26	
Piping connections	Liquid (Flare)	φ 6.4			φ 6.4		φ 9.5			
	Gas (Flare)	φ 12.7			φ 12.7		φ 15.9			
	Drain	VP25 (External Dia. 32/Internal Dia. 25)								

Notes: Specifications are based on the following conditions;

- Cooling: Indoor temp.: 27°CDB, 19°CWB, Outdoor temp.: 35°CDB, Equivalent piping length: 7.5 m, Height difference: 0 m.
- Heating: Indoor temp.: 20°CDB, Outdoor temp.: 7°CDB, 6°CWB, Equivalent piping length: 7.5 m, Height difference: 0 m.
- Capacity of indoor unit is only for reference. Actual capacity of indoor unit is based on the total capacity index. (See Engineering Data Book for details.)
- Sound level: Anechoic chamber conversion value, measured at a point 1.5 m downward from the unit centre. During actual operation, these values are normally somewhat higher as a result of ambient conditions.

### Panel (Option)

Standard panel with sensing	Model	BYCQ125EEF (Fresh White)	
	Dimensions(HxWxD)	mm	50x950x950
	Weight	kg	5.5
	Model	BYCQ125EEK (Black)	
Standard panel with sensing	Dimensions(HxWxD)	mm	50x950x950
	Weight	kg	5.5

### Function List

Remote controller	Wired		Wireless
	BRC1E63	BRC1H63W(K)	BRC7M634F(K)
Dual sensors *1	○	○	—
Auto airflow function (Direct airflow) *1	○	—	—
Auto airflow function (Draft prevention) *1	○	○	—
Sensing sensor low mode *1	○	○	—
Sensing sensor stop mode *1	○	○	—
Circulation airflow	○	—	—
Individual airflow direction control	○	○	—
Switchable 5 step fan speed	○	○	○
Auto airflow rate	○	○	○
Auto swing	○	○	○
Selectable airflow pattern	○	—	○
High ceiling application	○	○	—

\*1. Applicable when sensing panel is installed.

# Round Flow Cassette Type

FXFQ-A

360° airflow for improved comfort



## Circulation airflow\*1

### Configurations of circulation airflow

Circulation airflow cools the entire room to deliver comfort that never feels cold.

#### Cooling

During 2-way horizontal flow

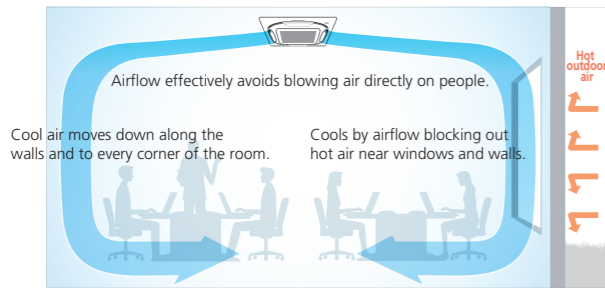

Comfort without cold air pockets at floor level.

4-way cassette (Swing)

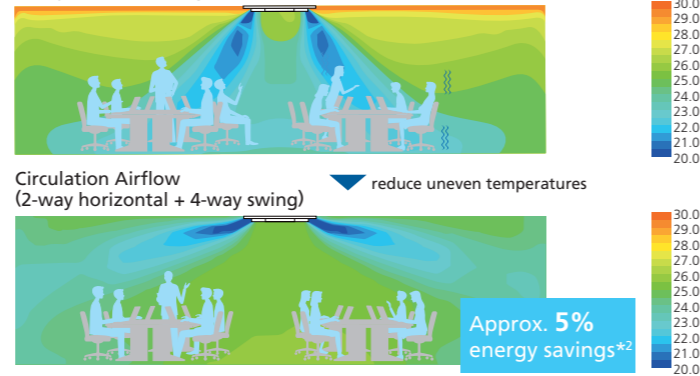

Comparison Conditions  
Room size: Width 7.5m x depth 7.5m x height 2.6m  
Indoor unit capacity: 71 class  
Outdoor air temperature: 35°C  
Airflow rate and air direction: high / swing

Operation (at start)

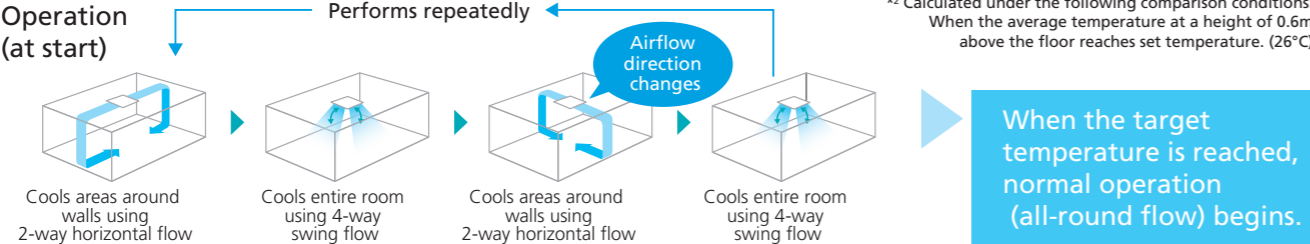

\*2 Calculated under the following comparison conditions:  
When the average temperature at a height of 0.6m above the floor reaches set temperature. (26°C)

Circulation airflow warms the entire room starting from your feet.

#### Heating

During 2-way horizontal flow



Warmth reliably reaches feet.

4-way cassette (Down blow)

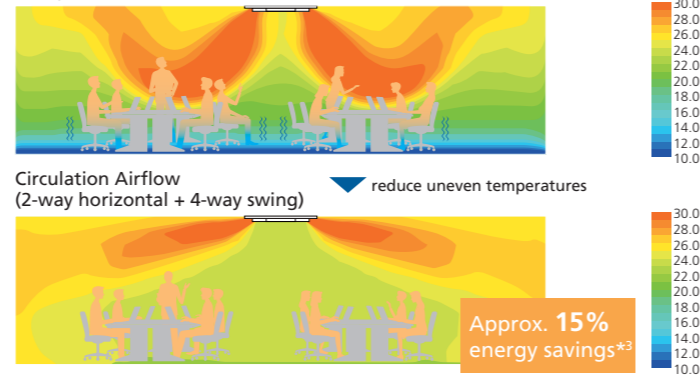

Comparison Conditions  
Room size: Width 7.5m x depth 7.5m x height 2.6m  
Indoor unit capacity: 71 class  
Outdoor air temperature: 5°C  
Airflow rate and air direction: high / Down blow

Operation (at start)

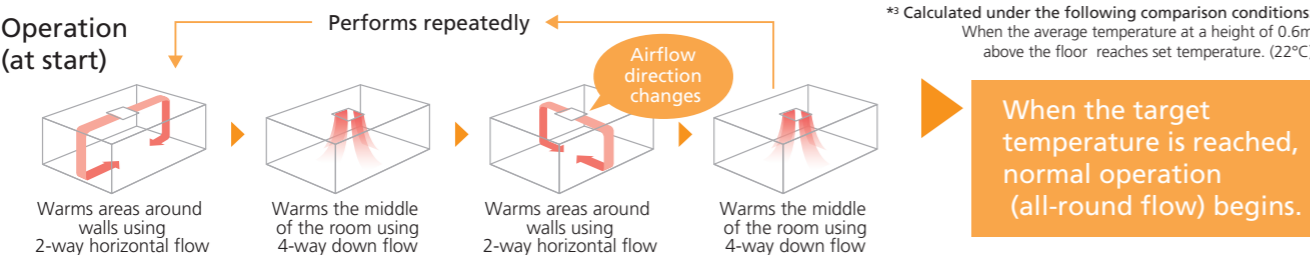

\*3 Calculated under the following comparison conditions:  
When the average temperature at a height of 0.6m above the floor reaches set temperature. (22°C)

## Individual airflow direction control

\* Applicable when wired remote controller BRC1E63 or BRC1H63W(K) is used.

### Comfortable air conditioning for all room layouts and conditions

Easy setting is possible with a wired remote controller

Airflow direction can be individually adjusted for each air discharge outlet to deliver optimal air distribution.

#### Individual airflow settings

- No individual setting (Auto airflow)
- Position 0 (Highest point)
- Position 1
- Position 2
- Position 3
- Position 4 (Lowest point)
- Swing

Individual settings are possible as stated above.

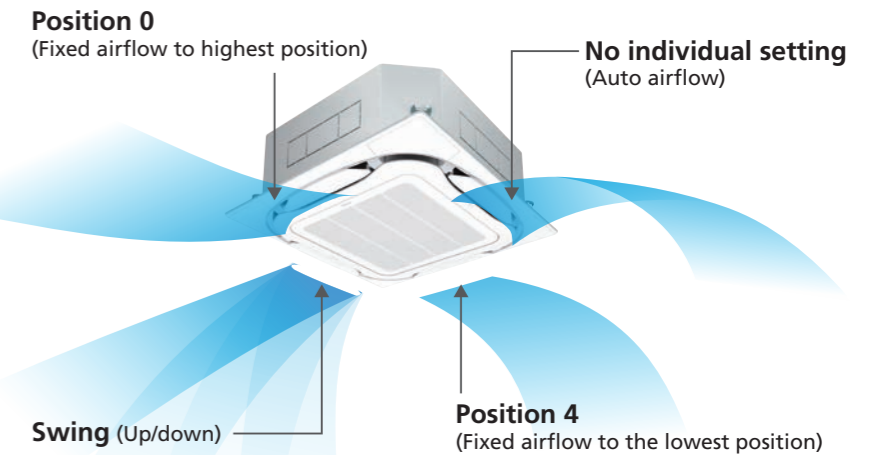

Comfort is provided to the entire room by individual setting corresponding to 4-way flow conditions.

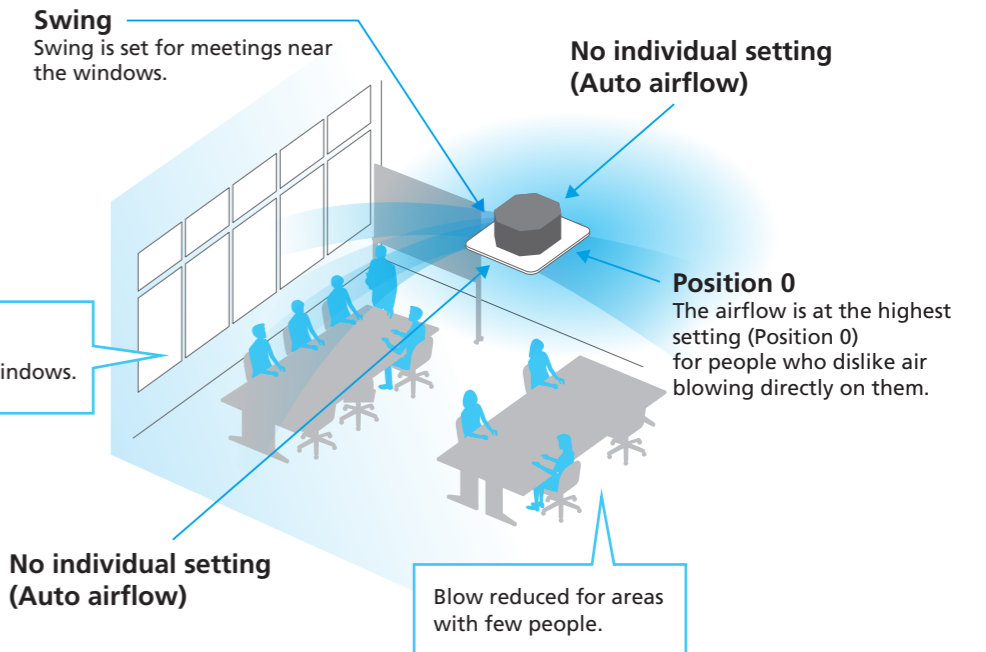



# Round Flow Cassette Type

## Other functions

### Comfort

From All-round flow to 2-way flow, various airflow patterns available.

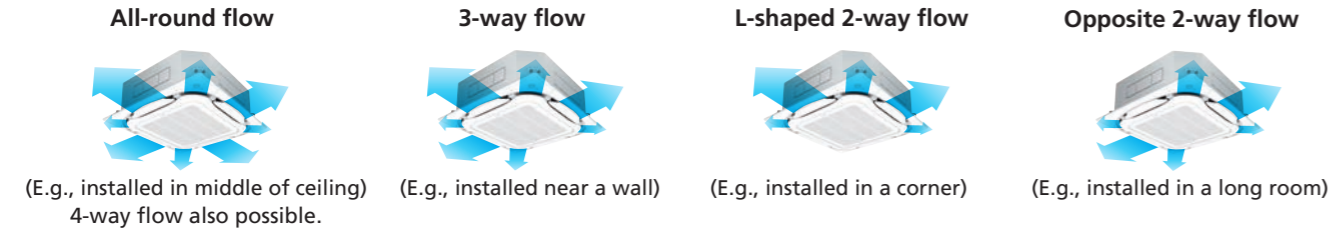

\* Whatever the discharge direction, the same type of panel is used. If installing for other than all-round flow, an air discharge outlet sealing material (option) must be used to close each unused outlet.

### Suitable for high ceilings

Even in spaces with high ceilings, a comfortable airflow is carried down to the floor level.

### Quick and easy installation

#### Installable in tight ceiling spaces

Min. of 261 mm\* ceiling space when using standard panel.

\* For FXFQ25-80A models.

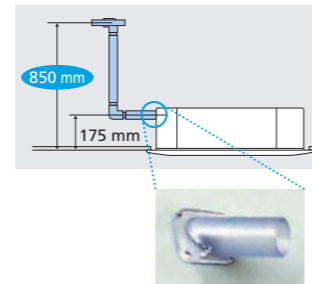

Drain pump is equipped as standard accessory with 850 mm lift.

### Easy maintenance

#### Drain pan and drain water check

The condition of the drain pan and drain water can be checked by removing the suction grille and drain plug.

Just open the suction grille!

Drain outlet (with rubber plug)

Note: For inquiries concerning auto grille panel installations, please contact your local dealer or Daikin representative.

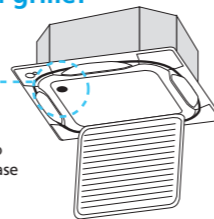

### Cleanliness

#### Silver ion anti-bacterial drain pan

Prevents the growth of slime, bacteria, and mould that cause odours and clogging.

\* Drain pan should be changed once every two to three years.



BAF552A160



High Performance Prefilter (MERV 8) (Option) See page 209

This filter can catch more harmful substances in the air such as PM2.5.

### Decoration Panel (Option)

#### Standard panel



Standard panel  
BYCQ125EAF (Fresh White)

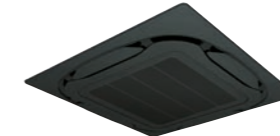

Standard panel  
BYCQ125EAK (Black)

#### Auto grille panel

Grille and air filter cleaning can be performed without need for a stepladder by lowering the grille.

A dedicated remote controller for the auto grille panel is included. Operation is not possible using other remote controllers.



Grille panel can be lowered to a maximum of 3.9 m.  
BYCQ125BSF (Fresh White)

### Specifications

MODEL		FXFQ25AVM	FXFQ32AVM	FXFQ40AVM	FXFQ50AVM	FXFQ63AVM	FXFQ80AVM	FXFQ100AVM	FXFQ125AVM	FXFQ140AVM	
Power supply		1-phase, 220-240 V/220-230 V, 50/60 Hz									
Cooling capacity	Btu/h	9,600	12,300	15,400	19,100	24,200	30,700	38,200	47,800	54,600	
	kW	2.8	3.6	4.5	5.6	7.1	9.0	11.2	14.0	16.0	
Heating capacity	Btu/h	10,900	13,600	17,100	21,500	27,300	34,100	42,700	47,800	54,600	
	kW	3.2	4.0	5.0	6.3	8.0	10.0	12.5	14.0	16.0	
Power consumption	Cooling	0.029		0.036	0.040	0.063	0.096	0.158	0.178	0.203	
	Heating	0.027		0.036	0.040	0.063	0.096	0.150	0.166	0.191	
Casing		Galvanised steel plate									
Airflow rate (H/HM/M/ML/L)	ℓ/s	217/208/192/183/167		283/225/208/200/183		383/342/317/242/183		392/350/333/267/225		408/367/342/333/250	
	m³/min	13/12.5/11.5/11/10		17/13.5/13/12/11		18/17/13.5/12.5/11		21/20/16/15/13.5		22.5/21.5/21/20/15	
Sound level (H/HM/M/ML/L)	dB(A)	30/29.5/28.5/28/27		35/29.5/29/28/27		35/33.5/29.5/28.5/27		36/35.5/31.5/31/28		37/36.5/36/35.5/29.5	
Dimensions (HxWxD)	mm	298x840x840									
Machine weight	kg	19			22			25		26	
Piping connections	Liquid (Flare)	ø 6.4			ø 9.5						
	Gas (Flare)	ø 12.7			ø 15.9						
	Drain	VP25 (External Dia. 32/Internal Dia. 25)									

Notes: Specifications are based on the following conditions;

- Cooling: Indoor temp.: 27°CDB, 19°CWB, Outdoor temp.: 35°CDB, Equivalent piping length: 7.5 m, Height difference: 0 m.
- Heating: Indoor temp.: 20°CDB, Outdoor temp.: 7°CDB, 6°CWB, Equivalent piping length: 7.5 m, Height difference: 0 m.
- Capacity of indoor unit is only for reference. Actual capacity of indoor unit is based on the total capacity index. (See Engineering Data Book for details.)
- Sound level: Anechoic chamber conversion value, measured at a point 1.5 m downward from the unit centre. During actual operation, these values are normally somewhat higher as a result of ambient conditions.

### Decoration Panel (Option)

Standard panel	Model	BYCQ125EAF (Fresh White) / BYCQ125EAK (Black)		
	Dimensions(HxWxD)	mm	50x950x950	
Weight	kg	5.5		
Auto grille panel	Model	BYCQ125BSF (Fresh White)		
	Dimensions(HxWxD)	mm	105x950x950	
	Weight	kg	8	

### Function List

Remote controller	Wired		Wireless
	BRC1E63	BRC1H63W(K)	BRC7M634F(K)
Circulation airflow	○	—	—
Individual airflow direction control	○	○	—
Switchable 5 step fan speed	○	○	○
Auto airflow rate	○	○	○
Auto swing	○	○	○
Selectable airflow pattern	○	○	○
High ceiling application	○	○	—

# Compact Multi Flow Cassette Type

**New** FXZQ-B

Quiet, compact, and designed for user comfort

## Compact & elegant design

- Fully-flat integration in standard architectural ceiling tiles, leaving only 8 mm
- Remarkable blend of iconic design and engineering excellence with an elegant finish in white
- The newly designed panel integrates fully within one ceiling tile enabling lights, speakers and sprinklers to be installed in the adjoining ceiling tiles.

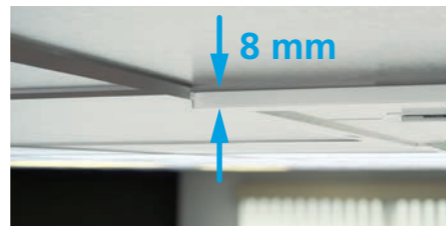

## Efficiency & comfort

### Dual sensors (Option)

- Two optional intelligent sensors improve energy efficiency and comfort.
- An optional presence and floor sensor kit can be fitted to the cassette for draught prevention, energy-saving operation and to provide optimal control of airflow.

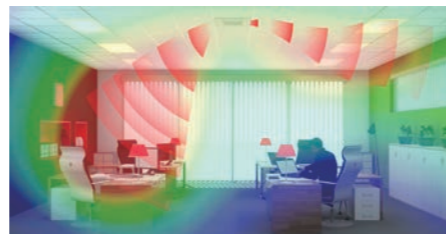

### Individual airflow direction control\*

- Airflow direction can be individually adjusted for each air discharge outlet to deliver optimal air distribution.

\*Applicable when wired remote controller BRC1E63 or BRC1H63W(K) is used.

### Auto swing (up/down)

Possibility to select automatic vertical moving of the air discharge flaps for efficient air and temperature distribution throughout the room.

## Cleanliness

**New** Streamer filter clean unit (Option) See page 5-6

Daikin Streamer technology enhances maximum efficiency in cleaning, which uses powerful decomposition properties to decompose substances captured by the filter for better air quality.

- Remarks:
- Only the stylish remote controller BRC1H63W(K) can be connected for ON/OFF operation of the streamer.
  - The Streamer function operates only when the fan and air conditioning operation are stopped. The maximum operation of Streamer is 180 minutes per day.



### Ceiling soiling prevention

Prevents air from blowing against the ceiling to prevent ceiling stains.

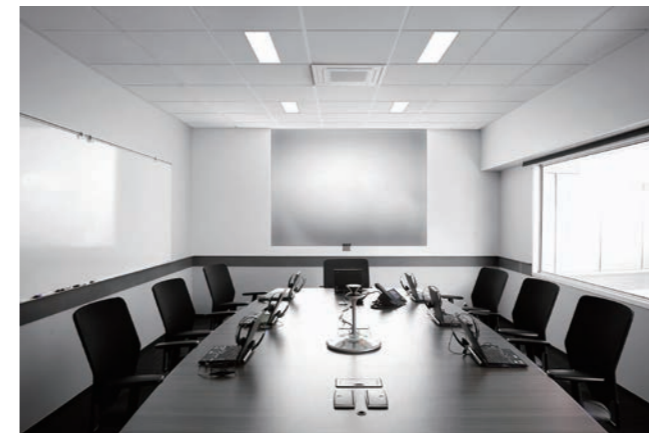

## Specifications

MODEL		FXZQ20BVM	FXZQ25BVM	FXZQ32BVM	FXZQ40BVM	FXZQ50BVM
Power supply		1-phase, 220-240 V/220-230 V, 50/60 Hz				
Cooling capacity	Btu/h	7,500	9,600	12,300	15,400	19,100
	kW	2.2	2.8	3.6	4.5	5.6
Heating capacity	Btu/h	8,500	10,900	13,600	17,100	21,500
	kW	2.5	3.2	4.0	5.0	6.3
Power consumption	Cooling	0.043		0.045	0.059	0.092
	Heating	0.036		0.038	0.053	0.086
Casing		Galvanised steel plate				
Airflow rate (H/M/L)	ℓ/s	145/125/108	150/133/108	167/142/117	192/158/133	242/208/167
	m <sup>3</sup> /min	8.7/7.5/6.5	9.0/8.0/6.5	10.0/8.5/7.0	11.5/9.5/8.0	14.5/12.5/10.0
Sound level (H/M/L)	dB(A)	32.0/29.5/25.5	33.0/30.0/25.5	33.5/30.0/26.0	37.0/32.0/28.0	43.0/40.0/33.0
Sound power (H)	dB(A)	49	50	51	54	60
Dimensions (HxWxD)	mm	260x575x575 (For depth add 63 mm for electrical box)				
Machine weight	kg	15.5		16.5		18.5
Piping connections	Liquid (Flare)	φ 6.4				
	Gas (Flare)	φ 12.7				
	Drain	VP20 (External Dia. 26/Internal Dia. 20)				

- Notes: Specifications are based on the following conditions;
- Cooling: Indoor temp.: 27°CDB, 19°CWB, Outdoor temp.: 35°CDB, Equivalent piping length: 7.5 m, Height difference: 0 m.
  - Heating: Indoor temp.: 20°CDB, Outdoor temp.: 7°CDB, 6°CWB, Equivalent piping length: 7.5 m, Height difference: 0 m.
  - Capacity of indoor unit is only for reference. Actual capacity of indoor unit is based on the total capacity index. (See Engineering Data Book for details.)
  - Sound level: Anechoic chamber conversion value, measured at a point 1.5 m downward from the unit centre. During actual operation, these values are normally somewhat higher as a result of ambient conditions.

## Panel (Option)

Panel type	Grid ceiling panel
Appearance	
Model	BYFQ60CAW
Colour	White (N9.5)
Dimensions (HxWxD)	mm 46x620x620
Weight	kg 2.8



# Double Flow Cassette Type

**New FXCQ-B**

Thin, lightweight, and easy to install in narrow ceiling spaces



## Stylish design

- Stylish unit blends easily with any interior.
- The flat flaps close entirely when the unit is not operating and there are no air intake grilles visible.
- Depth of all units is 620 mm, ideal for narrow spaces



## Comfort

### Individual airflow direction control\*

- Airflow direction can be individually adjusted for each air discharge outlet to deliver optimal air distribution.

\*Applicable when wired remote controller BRC1E63 or BRC1H63W(K) is used.

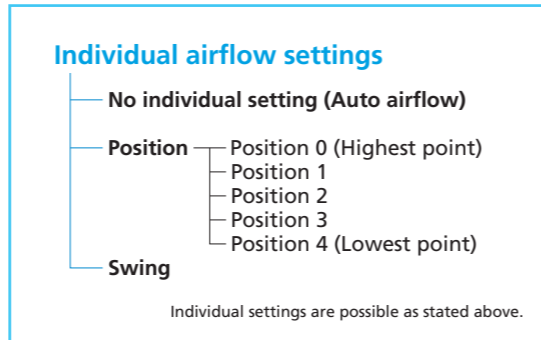
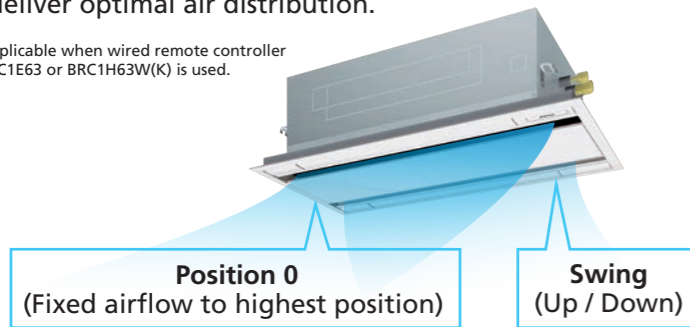

### 5-step & auto airflow control

- Control of airflow rate has been improved from 3-step to 5-step. Auto airflow rate is newly available.

### Suitable for high ceilings

- Even in spaces with high ceilings maximum 3.5 m, a comfortable airflow is carried down to the floor level.

## Energy saving

- Power consumption is significantly reduced by specially developed small tube heat exchanger and DC fan motor.

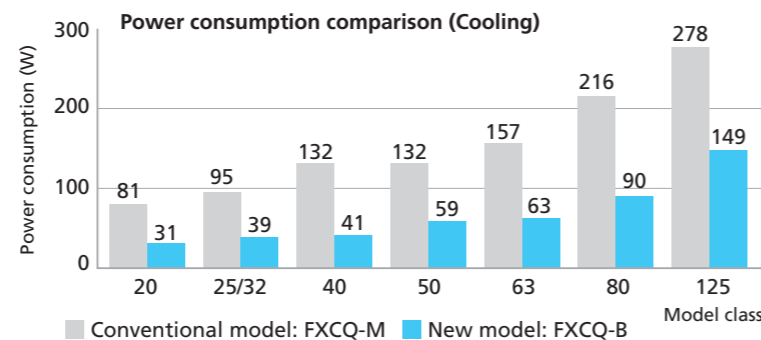

## Easy maintenance

- The flap parts are easy to clean because it is hard to condensate and get dirty.
- Check contamination in drain pan by simply removing suction grille and panel.
- Adjuster pockets mount at four corners of the unit enable to adjust the main unit without removing the panel.

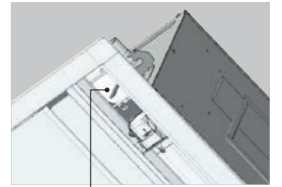

Adjuster Pocket

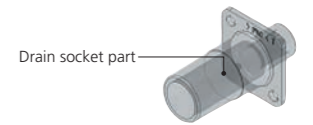

Drain socket part

## Flexible installation

- Drain pump is equipped as standard accessory with 850 mm lift.

## Cleanliness

**New Streamer filter clean unit (Option)** See page 5-6

Daikin Streamer technology enhances maximum efficiency in cleaning, which uses powerful decomposition properties to decompose substances captured by the filter for better air quality.

Remarks:

- 1) Only the stylish remote controller BRC1H63W(K) can be connected for ON/OFF operation of the streamer.
- 2) The Streamer function operates only when the fan and air conditioning operation are stopped. The maximum operation of Streamer is 180 minutes per day.



STREAMER



BAPW55A61

### Silver ion anti-bacterial drain pan

- Prevents the growth of slime, bacteria, and mould that cause odours and clogging.

\* Drain pan should be changed once every two to three years.



### Filter has anti-mould and antibacterial treatment

## Specifications

MODEL		FXCQ20BVM	FXCQ25BVM	FXCQ32BVM	FXCQ40BVM	FXCQ50BVM	FXCQ63BVM	FXCQ80BVM	FXCQ125BVM
Power supply		1-phase, 220-240 V/220-230 V, 50/60 Hz							
Cooling capacity	Btu/h	7,500	9,600	12,300	15,400	19,100	24,200	30,700	47,800
	kW	2.2	2.8	3.6	4.5	5.6	7.1	9.0	14.0
Heating capacity	Btu/h	8,500	10,900	13,600	17,100	21,500	27,300	34,100	54,600
	kW	2.5	3.2	4.0	5.0	6.3	8.0	10.0	16.0
Power consumption	Cooling	0.031	0.039	0.041	0.059	0.063	0.090	0.149	
	Heating	0.028	0.035	0.037	0.056	0.060	0.086	0.146	
Casing		Galvanised steel plate							
Airflow rate (H/HM/M/ML/L)	ℓ/s	175/158/150/133/125	192/175/158/142/133	200/183/175/158/142	250/233/217/192/175	267/250/233/208/192	433/400/375/342/308	533/492/458/417/375	
	m <sup>3</sup> /min	10.5/9.5/9/8/7.5	11.5/10.5/9.5/8.5/8	12/11/10.5/9.5/8.5	15/14/13/11.5/10.5	16/15/14/12.5/11.5	26/24/22.5/20.5/18.5	32/29.5/27.5/25/22.5	
Sound level (H/HM/M/ML/L)	dB(A)	32/31/30/29/28	34/33/31/30/29	34/33/32/31/30	36/35/33/32/31	37/36/35/33/31	39/38/37/35/32	42/40/38/36/33	46/44/42/40/38
Dimensions (H x W x D)	mm	305x775x620			305x990x620		305x1,445x620		
Machine weight	kg	19		22	25	33	38		
Piping connections	Liquid (Flare)	φ 6.4			φ 9.5		φ 15.9		
	Gas (Flare)	φ 12.7			φ 15.9		φ 15.9		
	Drain	VP25 (External Dia. 32/Internal Dia. 25)							
Panel (Option)	Model	BYBCQ40CF			BYBCQ63CF		BYBCQ125CF		
	Colour	Fresh white (6.5Y 9.5/0.5)							
	Dimensions (HxWxD)	55x1,070x700			55x1,285x700		55x1,740x700		
	Weight	10			11		13		

Notes: Specifications are based on the following conditions;

- Cooling: Indoor temp.: 27°CDB, 19°CWB, Outdoor temp.: 35°CDB, Equivalent piping length: 7.5 m, Height difference: 0 m.
- Heating: Indoor temp.: 20°CDB, Outdoor temp.: 7°CDB, 6°CWB, Equivalent piping length: 7.5 m, Height difference: 0 m.
- Capacity of indoor unit is only for reference. Actual capacity of indoor unit is based on the total capacity index. (See Engineering Data Book for details.)
- Sound level: Anechoic chamber conversion value, measured at a point 1.5 m downward from the unit centre. During actual operation, these values are normally somewhat higher as a result of ambient conditions.

# Single Flow Cassette Type

FXEQ-A

Slim design for flexible installation



## Slim design

- The body features a compact design with a height of just 200 mm and depth 470 mm, making the installation possible in tight ceiling spaces.
- The novel smooth panel design makes dust difficult to accumulate, thus causing the cleaning more conveniently.

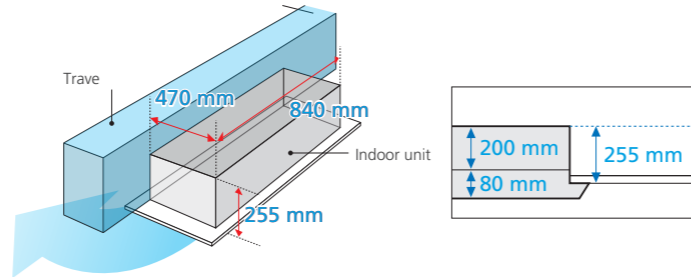

## Comfort

- The swinging of horizontal and vertical swing flaps can be adjusted freely with the remote controller, providing 3D airflow to every corner of the room.
- Control of airflow rate can be selected from 5-step control, Automatic and quiet operation mode, which provides comfortable airflow.
- DC motor is adopted both in the fan and drain pump of the indoor unit, not only enhancing the energy saving performance, but also reducing the operating sound and the vibration incurred to the unit.
- While creating a cozy indoor environment, the unit can prevent the suspended ceiling from being soiled by adjusting its louvre angle.

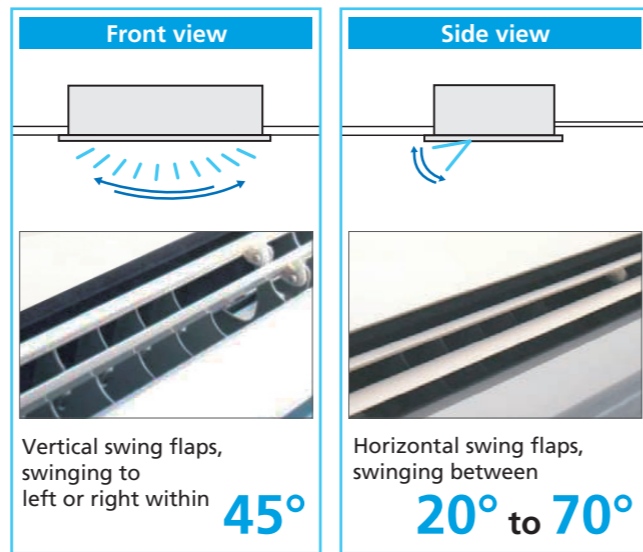

## Easy maintenance

- Drain pump is equipped as standard accessory with 850 mm lift.

- Maintenance operations can be performed by removing the front panel.

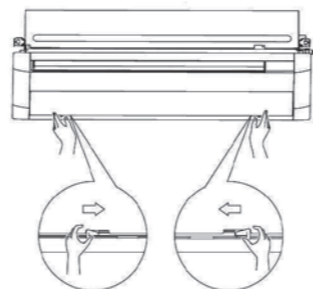

## Specifications

MODEL		FXEQ20AV36	FXEQ25AV36	FXEQ32AV36	FXEQ40AV36	FXEQ50AV36	FXEQ63AV36	
Power supply		1-phase, 220-240 V, 50 Hz						
Cooling capacity	Btu/h	7,500	9,600	12,300	15,400	19,100	24,200	
	kW	2.2	2.8	3.6	4.5	5.6	7.1	
Heating capacity	Btu/h	8,500	10,900	13,600	17,100	21,500	27,300	
	kW	2.5	3.2	4.0	5.0	6.3	8.0	
Power consumption	Cooling	0.026	0.027	0.034	0.046	0.048	0.067	
	Heating	0.022	0.023	0.030	0.042	0.044	0.063	
Casing		Galvanised steel plate						
Airflow rate (H/HM/M/ML/L)	Cooling	ℓ/s	100/90/82/73/67	115/107/97/88/80	133/125/117/105/92	163/147/130/117/103	208/190/173/158/145	150/227/203/183/163
		m³/min	6.0/5.4/4.9/4.4/4.0	6.9/6.4/5.8/5.3/4.8	8.0/7.5/7.0/6.3/5.5	9.8/8.8/7.8/7.0/6.2	12.5/11.4/10.4/9.5/8.7	15.0/13.6/12.2/11.0/9.8
	Heating	ℓ/s	100/93/85/78/70	120/112/102/93/83	143/133/123/112/100	170/155/140/127/113	233/213/193/178/163	282/255/227/205/183
		m³/min	6.0/5.6/5.1/4.7/4.2	7.2/6.7/6.1/5.6/5.0	8.6/8.0/7.4/6.7/6.0	10.2/9.3/8.4/7.6/6.8	14.0/12.8/11.6/10.7/9.8	16.9/15.3/13.6/12.3/11.0
Sound level (H/HM/M/ML/L)	Cooling	30/29/28/27/26	32/31/30/29/28	35/34/33/32/30	38/37/35/33/31	38/37/35/33/31	43/41/39/37/35	
	Heating	33/31/29/28/26	35/33/31/30/28	38/36/34/33/31	41/39/37/35/33	41/39/37/36/34	46/44/42/40/38	
Dimensions (HxWxD)	mm	200x840x470				200x1,240x470		
Machine weight	kg	17			18	23		
Piping connections	Liquid (Flare)	φ 6.4					φ 9.5	
	Gas (Flare)	φ 12.7					φ 15.9	
	Drain	PVC26 (External Dia. 26/Internal Dia. 20)						
Panel (Option)	Model	BYEP40AW1				BYEP63AW1		
	Colour	Fresh white						
	Dimensions(HxWxD)	80x950x550				80x1,350x550		
	Weight	8.0				10.0		

Notes: Specifications are based on the following conditions;  
 • Cooling: Indoor temp.: 27°CDB, 19°CWB, Outdoor temp.: 35°CDB, Equivalent piping length: 7.5 m, Height difference: 0 m.  
 • Heating: Indoor temp.: 20°CDB, Outdoor temp.: 7°CDB, 6°CWB, Equivalent piping length: 7.5 m, Height difference: 0 m.  
 • Capacity of indoor unit is only for reference. Actual capacity of indoor unit is based on the total capacity index. (See Engineering Data Book for details.)  
 • Sound level: Anechoic chamber conversion value, measured at a point 1 m in front of the unit and 1 m downward.



# Slim Duct (Standard) Type

FXDQ-PD / ND

Slim design, quietness and ideal for drop-ceilings

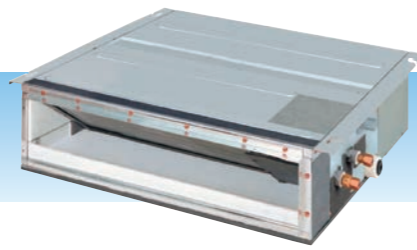

## Comfort

- Control of the airflow rate can be selected from 3-step control and Auto. Auto airflow rate control can be selected with wired remote controller.
- Low operation sound level: down to 23 dB(A)

## Installation flexibility

- Only 200 mm in height, this model can be installed in rooms with as little as 240 mm in height for the ceiling space between the drop-ceiling and ceiling slab.

Great for hotel use!

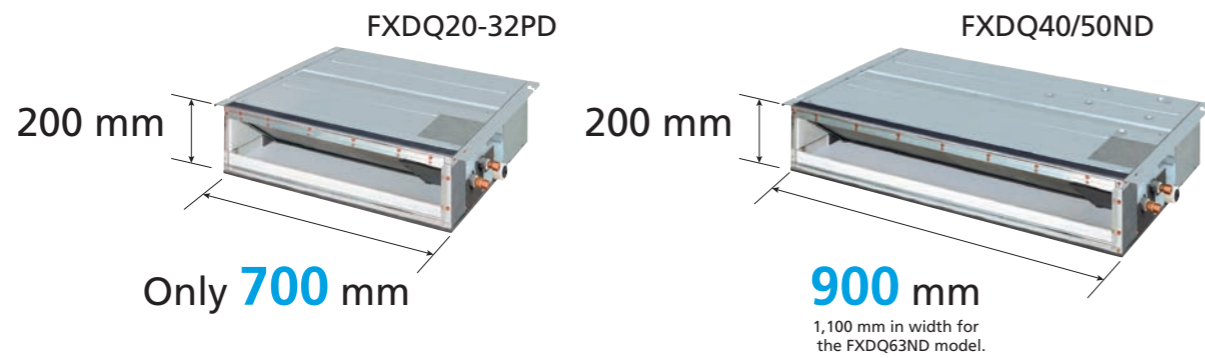

- Drain pump is equipped as standard accessory with 750 mm lift.



## Specifications

MODEL	FXDQ20PDVE	FXDQ25PDVE	FXDQ32PDVE	FXDQ40NDVE	FXDQ50NDVE	FXDQ63NDVE	
Power supply	1-phase, 220-240 V/220 V, 50/60 Hz						
Cooling capacity	Btu/h	7,500	9,600	12,300	15,400	19,100	
	kW	2.2	2.8	3.6	4.5	5.6	
Heating capacity	Btu/h	8,500	10,900	13,600	17,100	21,500	
	kW	2.5	3.2	4.0	5.0	6.3	
Power consumption	Cooling	0.086		0.089	0.160	0.181	
	Heating	0.067		0.070	0.147	0.168	
Casing	Galvanised steel plate						
Airflow rate (HH/H/L)	ℓ/s	133/120/106		175/158/141	208/183/166	275/241/216	
	m <sup>3</sup> /min	8.0/7.2/6.4		10.5/9.5/8.5	12.5/11.0/10.0	16.5/14.5/13.0	
External static pressure	Pa	30-10 *2		44-15 *2			
Sound level (HH/H/L) *1 *3	dB(A)	28/26/23		28/26/24	30/28/26	33/31/29	
Sound power (HH/H/L)	dB(A)	56/54/51		56/54/52	58/56/54	61/59/57	
Dimensions (HxWxD)	mm	200x700x620			200x900x620		
Machine weight	kg	23		27	28	31	
Piping connections	Liquid (Flare)	ϕ6.4				ϕ9.5	
	Gas (Flare)	ϕ12.7				ϕ15.9	
	Drain	VP20 (External Dia. 26/Internal Dia. 20)					

Notes: Specifications are based on the following conditions;

- Cooling: Indoor temp.: 27°CDB, 19°CWB, Outdoor temp.: 35°CDB, Equivalent piping length: 7.5 m, Height difference: 0 m.
- Heating: Indoor temp.: 20°CDB, Outdoor temp.: 7°CDB, 6°CWB, Equivalent piping length: 7.5 m, Height difference: 0 m.
- Capacity of indoor unit is only for reference. Actual capacity of indoor unit is based on the total capacity index. (See Engineering Data Book for details.)
- Sound level: Anechoic chamber conversion value, measured at a point 1.5 m downward from the unit centre.

During actual operation, these values are normally somewhat higher as a result of ambient conditions.

\*1: Values are based on the following conditions: FXDQ-PD: external static pressure of 10 Pa; FXDQ-ND: external static pressure of 15 Pa.

\*2: External static pressure is changeable to set by the remote controller. This pressure means "High static pressure - Standard". (Factory setting is 10 Pa for FXDQ-PD models and 15 Pa for FXDQ-ND models.)

\*3: The values of operation sound level represent those for rear-suction operation. Sound level values for bottom-suction operation can be obtained by adding 5 dB(A).

# Slim Duct (Compact) Type

FXDQ-T

Slim and compact design for easy and flexible installation

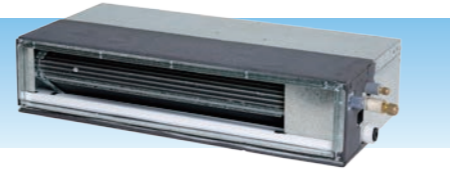

## Energy saving

- Adoption of a DC motor for both the fan motor and the drain pump has greatly reduced power consumption.

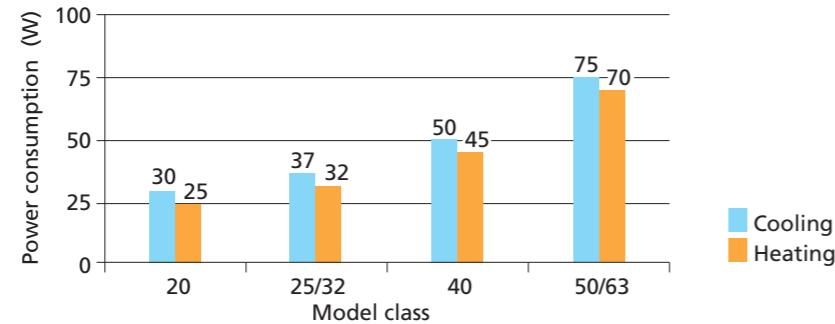

## Comfort

### 5-step & auto airflow control

- Control of airflow rate can be selected from 5-step and Auto to provide comfortable airflow.

### 3-D auto swing discharge grille (Option)

- Motorised louvres provide 3-D airflow distribution. Operations via BRC1E63 with functions including 3-D Auto Swing, Horizontal Auto Swing, Vertical Auto Swing & Fixed Positioning.

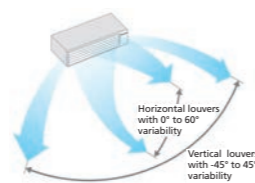

Model	Compatibility	HxWxD (mm)
BDG20A09	20-32 Class	180x722x70
BDG20A15	40-50 Class	180x922x70
BDG20A20	63 Class	180x1,122x70

## Installation flexibility

- Slim and compact design with a height of only 200 mm and the depth of only 450 mm which is suitable to install in limited spaces.
- Features rear or bottom return to suite site constraints.

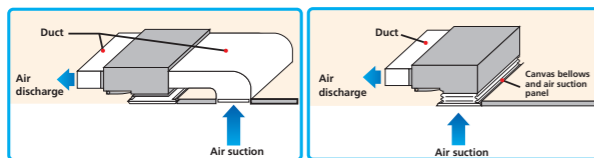
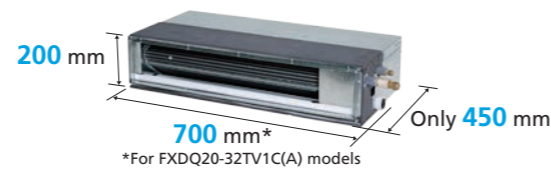

### Air filter included

Clip-on resin net filter attached to the rear of the unit as standard.

- Drain pump is equipped as standard accessory with 750 mm lift.

## Easy maintenance

### Auto clean air filter module (Option)

- A unique rear suction mounted motorised filter cleaning module with included polyester filter for convenient filter maintenance to ensure optimal performance and increased energy savings.

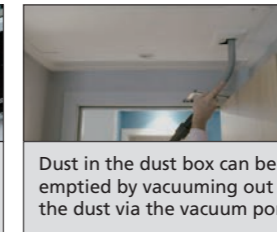
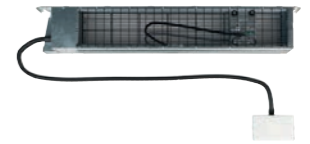

Model	Compatibility	HxWxD (mm)
BAE20A62	20-32 Class	210x840x188
BAE20A82	40-50 Class	210x1,040x188
BAE20A102	63 Class	210x1,240x188

## Design flexibility

### Two series available

FXDQ-TV1C – Standard Model

FXDQ-TV1CA – Features Built-in Multi Tenancy Kit

Multi Tenancy Kit allows an independent 24V power source to be supplied to the indoor unit PCB in conjunction with 1 phase power from the tenants board. This ensures critical operations, such as oil return are not affected should there be an interruption to the main indoor unit power.

## Specifications

MODEL		FXDQ20TV1C(A)	FXDQ25TV1C(A)	FXDQ32TV1C(A)	FXDQ40TV1C(A)	FXDQ50TV1C(A)	FXDQ63TV1C(A)
Power supply		1-phase, 220-240/220-230 V, 50/60 Hz					
Cooling capacity	Btu/h	7,500	9,600	12,300	15,400	19,100	24,200
	kW	2.2	2.8	3.6	4.5	5.6	7.1
Heating capacity	Btu/h	8,500	10,900	13,600	17,100	21,500	27,300
	kW	2.5	3.2	4.0	5.0	6.3	8.0
Power consumption <sup>1)</sup>	Cooling	0.030		0.037	0.050	0.075	
	Heating	0.025		0.032	0.045	0.070	
Casing		Galvanized steel plate					
Airflow rate	l/s	135	150	210	250	325	
	m <sup>3</sup> /min	8.1	9.0	12.6	15.0	19.5	
External static pressure		40-10 <sup>-2</sup>		50-10 <sup>-2</sup>	60-10 <sup>-2</sup>	45-10 <sup>-2</sup>	
Sound level (HH/H/L) <sup>1) 2)</sup>		32/30/28		33/30.5/28	34/31.5/29	35/32.5/30	37/35/33
Dimensions (HxWxD)		200x700x450			200x900x450		200x1,100x450
Machine weight		18			21		24
Piping connections	Liquid (Flare)	ø 6.4					
	Gas (Flare)	ø 12.7					
	Drain	PVC26 (External Dia. 26 / Internal Dia. 20)					

Notes: Specifications are based on the following conditions;

- Cooling: Indoor temp.: 27°CDB, 19°CWB, Outdoor temp.: 35°CDB, Equivalent piping length: 5 m, Height difference: 0 m.
- Heating: Indoor temp.: 20°CDB, Outdoor temp.: 7°CDB, 6°CWB, Equivalent piping length: 5 m, Height difference: 0 m.
- Capacity of indoor unit is only for reference. Actual capacity of indoor unit is based on the total capacity index. (See Engineering Data Book for details.)
- Sound level: Anechoic chamber conversion value, measured at a point 1.5 m downward from the unit centre. During actual operation, these values are normally somewhat higher as a result of ambient conditions.
- \*1: Values are based on external static pressure of 10 Pa. For FXDQ-TV1CA models, +0.0005kW on top of cooling/heating power consumption values.
- \*2: External static pressure is changeable to set by the remote controller. This pressure means "High static pressure - Standard". (Factory setting is 10 Pa)
- \*3: The values of operation sound level represent those for rear-suction operation. Sound level values for bottom-suction operation can be obtained by adding 5 dB(A).



# Middle Static Pressure Duct Type

## FXSQ-PA

Middle static pressure and slim design allow flexible installations



## Installation flexibility

### Slim design

- With a height of only 245 mm, installation is possible even in buildings with narrow ceiling spaces.



### Standard DC drain pump

- DC drain pump is equipped as standard accessory with 850 mm lift.

### Bottom suction possible

- Bottom suction is possible which facilitates installation and maintenance. Wiring connections and maintenance of control box can be done from under the unit with an optional shield plate for side plate.

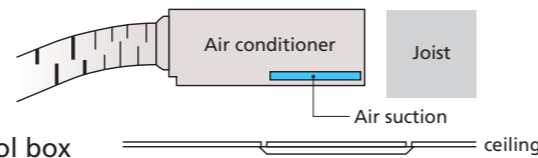

## Design flexibility

### Adjustable external static pressure

- Using a DC fan motor, the external static pressure can be controlled within a range of 30 Pa\* to 150 Pa.

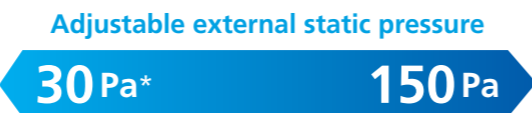

\* 30 Pa-150 Pa for FXSQ20-40PAVE  
50 Pa-150 Pa for FXSQ50-125PAVE  
50 Pa-140 Pa for FXSQ140PAVE

## Easy installation

### "Airflow rate auto adjustment function" at field setting (local setting by remote controller)

\*This function can only be set via wired remote controller.

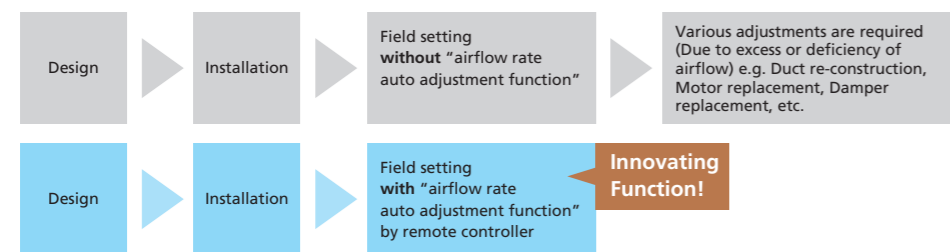

<Mechanism>

- During field setting, power input of DC fan is detected.
- External static pressure is estimated from power input of DC fan because PCB of FXSQ-PA has table of external static pressure vs. power input of DC fan.
- Actual duct resistance is calculated according to 1 and 2.
- Fan speed is automatically adjusted to produce rated airflow.

Notes: "Airflow rate auto adjustment function" can be adjusted within ±10% of rated airflow. (Refer to Engineering Data Book for details)  
"Airflow rate auto adjustment function" should be used at field setting only.

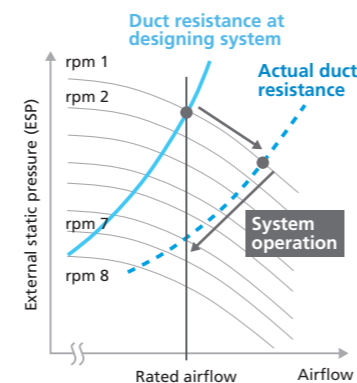

## Comfort

- Control of the airflow rate can be selected from 3-step control. Auto airflow rate control can be selected with wired remote controller.
- Lower sound level: down to 28 dB(A)

## Easy maintenance

- Inspection and cleaning is facilitated by separating the drain pipe and inspection opening and by the drain pan maintenance check hole.

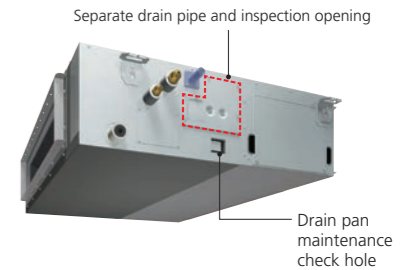

## Cleanliness

### Silver ion anti-bacterial drain pan

- Prevents the growth of slime, bacteria, and mould that cause odours and clogging.

\* Drain pan should be changed once every two to three years.



### Filter has anti-mould and antibacterial treatment

## Specifications

MODEL		FXSQ20PAVE	FXSQ25PAVE	FXSQ32PAVE	FXSQ40PAVE	FXSQ50PAVE
Power supply		1-phase, 220-240 V/220 V, 50/60 Hz				
Cooling capacity	Btu/h	7,500	9,600	12,300	15,400	19,100
	kW	2.2	2.8	3.6	4.5	5.6
Heating capacity	Btu/h	8,500	10,900	13,600	17,100	21,500
	kW	2.5	3.2	4.0	5.0	6.3
Power consumption	Cooling	0.058*1		0.066*1	0.101*1	0.075*1
	Heating	0.053*1		0.061*1	0.096*1	0.070*1
Casing		Galvanised steel plate				
Airflow rate (H/M/L)	ℓ/s	150/125/108		158/133/116	250/208/175	283/242/192
	m <sup>3</sup> /min	9/7.5/6.5		9.5/8/7	15/12.5/10.5	17/14.5/11.5
External static pressure	Pa	30-150 (50) *2				50-150 (50) *2
Sound level (H/M/L)	dB(A)	33/30/28		34/32/30	36/33/30	34/32/29
Sound power (H)	dB(A)	61		62	64	62
Dimensions (H×W×D)	mm	245×550×800			245×700×800	245×1,000×800
Machine weight	kg	25			27	35
Piping connections	Liquid (Flare)	∅ 6.4				
	Gas (Flare)	∅ 12.7				
	Drain	VP25 (External Dia. 32/Internal Dia. 25)				

MODEL		FXSQ63PAVE	FXSQ80PAVE	FXSQ100PAVE	FXSQ125PAVE	FXSQ140PAVE
Power supply		1-phase, 220-240 V/220 V, 50/60 Hz				
Cooling capacity	Btu/h	24,200	30,700	38,200	47,800	54,600
	kW	7.1	9.0	11.2	14.0	16.0
Heating capacity	Btu/h	27,300	34,100	42,700	54,600	61,400
	kW	8.0	10.0	12.5	16.0	18.0
Power consumption	Cooling	0.106*1		0.126*1	0.151*1	0.206*1
	Heating	0.101*1		0.121*1	0.146*1	0.201*1
Casing		Galvanised steel plate				
Airflow rate (H/M/L)	ℓ/s	350/292/242		383/325/267	533/450/375	617/525/433
	m <sup>3</sup> /min	21/17.5/14.5		23/19.5/16	32/27/22.5	37/31.5/26
External static pressure	Pa	50-150 (50) *2				50-140 (50) *2
Sound level (H/M/L)	dB(A)	36/32/29		37.5/34/30	39/35/32	42/38.5/35
Sound power (H)	dB(A)	64		65.5	67	70
Dimensions (H×W×D)	mm	245×1,000×800		245×1,400×800		245×1,550×800
Machine weight	kg	35		37	46	52
Piping connections	Liquid (Flare)	∅ 9.5				
	Gas (Flare)	∅ 15.9				
	Drain	VP25 (External Dia. 32/Internal Dia. 25)				

Notes:

- Specifications are based on the following conditions:  
• Cooling: Indoor temp.: 27°CDB, 19°CWB, Outdoor temp.: 35°CDB, Equivalent piping length: 7.5 m, Height difference: 0 m.  
• Heating: Indoor temp.: 20°CDB, Outdoor temp.: 7°CDB, 6°CWB, Equivalent piping length: 7.5 m, Height difference: 0 m.  
• Capacity of indoor unit is only for reference. Actual capacity of indoor unit is based on the total capacity index. (See Engineering Data Book for details.)  
• Sound level: Anechoic chamber conversion value, measured at a point 1.5 m downward from the unit centre. During actual operation, these values are normally somewhat higher as a result of ambient conditions.

\*1: Power consumption values are based on conditions of rated external static pressure.

\*2: External static pressure can be modified using a remote controller that offers thirteen (FXSQ20-40PA), eleven (FXSQ50-125PA) or ten (FXSQ140PA) levels of control. These values indicate the lowest and highest possible static pressures. The rated static pressure is 50 Pa.

# Middle Static Pressure Duct Type

FXDYQ-MA

Middle static pressure allows for flexible duct design.

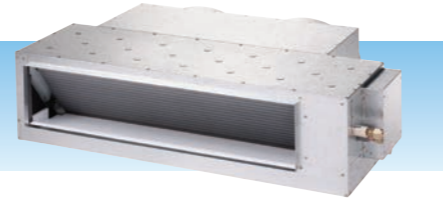

## Energy saving

- High efficiency Hi-X heat exchanger coils that provide even more energy savings.



## Installation flexibility

- High external static pressure of 120 Pa allows comprehensive duct layout for various applications.
- Two external static pressure settings for added flexibility.
- Return air spigots included for ease of installation.
- Quiet yet powerful supply air fan.
- High strength galvanised steel casing.

## Specifications

MODEL		FXDYQ80MAV1	FXDYQ100MAV1	FXDYQ125MAV1	FXDYQ145MAV1
Power supply		1-phase, 220-240 V, 50 Hz			
Cooling capacity	Btu/h	30,000	38,200	47,400	54,600
	kW	8.8	11.2	13.9	16.0
Heating capacity	Btu/h	33,800	42,700	54,600	62,800
	kW	9.9	12.5	16.0	18.4
Power consumption	Cooling	0.415	0.700	0.780	0.880
	Heating	0.415	0.700	0.780	0.880
Casing		Galvanised steel plate			
Airflow rate (H)	ℓ/s	510	778	852	957
	m <sup>3</sup> /min	30.6	46.7	51.1	57.4
External static pressure		120 *1			
Sound level (H)	240 V dB(A)	45	46	48	51
Dimensions (HxWxD)		360x1168x869		360x1478x899	
Machine weight		50	60	65	66
Piping connections	Liquid (Flare)	ϕ 9.5			
	Gas (Flare)	ϕ 15.9			
	Drain	VP25 (External Dia. 32/Internal Dia. 25)			

Note: Specifications are based on the following conditions;  
 •Cooling: Indoor temp.: 27°CDB, 19°CWB, Outdoor temp.: 35°CDB, Equivalent piping length: 7.5 m, Height difference: 0 m.  
 •Heating: Indoor temp.: 20°CDB, Outdoor temp.: 7°CDB, 6°CWB, Equivalent piping length: 7.5 m, Height difference: 0 m.  
 •Capacity of indoor unit is only for reference. Actual capacity of indoor unit is based on the total capacity index. (See Engineering Data Book for details.)  
 •Sound level: Anechoic chamber conversion value, measured at a point 1.5 m downward from the unit centre.  
 During actual operation, these values are normally somewhat higher as a result of ambient conditions.

\*1: External static pressure is changeable to change over the connectors inside electrical box (High static pressure-Standard static pressure).  
 The data above is for high static pressure setting.



# Middle-High Static Pressure Duct Type

## FXMQ-PA

Middle and high static pressure allows for flexible duct design



## Design flexibility

Using a DC fan motor, the external static pressure can be controlled within a range of 30 Pa\* to 200 Pa\*.

Adjustable external static pressure

30 Pa\* 200 Pa

\*30 Pa – 100 Pa for FXMQ20PA-32PA  
 \*30 Pa – 160 Pa for FXMQ40PA  
 \*50 Pa – 200 Pa for FXMQ50PA-125PA  
 \*50 Pa – 140 Pa for FXMQ140PA



## Easy installation

“Airflow rate auto adjustment function” at field setting (local setting by remote controller)

\*This function is not available with FXMQ140PAVE.  
 \*This function can only be set via wired remote controller.

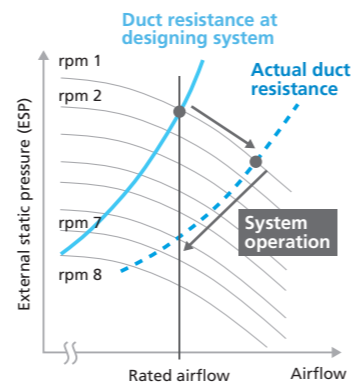
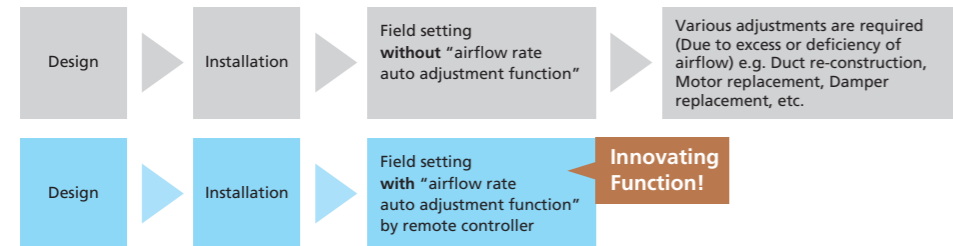

- <Mechanism>  
 1. During field setting, power input of DC fan is detected.  
 2. External static pressure is estimated from power input of DC fan because PCB of FXMQ-PA has table of external static pressure vs. power input of DC fan.  
 3. Actual duct resistance is calculated according to 1 and 2.  
 4. Fan speed is automatically adjusted to produce rated airflow.

Notes: “Airflow rate auto adjustment function” can be adjusted within ±10% of rated airflow. (Refer to Engineering Data Book for details)  
 “Airflow rate auto adjustment function” should be used at field setting only.

- All models are only 300 mm in height and the weight of the FXMQ40-140PA has been reduced.
- Drain pump is equipped as standard accessory with 700 mm lift.

## Comfort

- Control of the airflow rate can be selected from 3-step control and Auto. Auto airflow rate control can be selected with wired remote controller.
- Low operation sound level: down to 29 dB(A)

## Energy saving

- DC fan motor is used to realise energy-saving operation.

## Easy maintenance

Inspection and cleaning is facilitated by separating the drain pipe and inspection opening and by the drain pan maintenance check hole.

Separate drain pipe and inspection opening



Drain pan maintenance check hole

## Cleanliness

Silver ion anti-bacterial drain pan

Prevents the growth of slime, bacteria, and mould that cause odours and clogging.

\*Drain pan should be changed once every two to three years.



Filter has anti-mould and antibacterial treatment

## Specifications

MODEL	FXMQ20PAVE	FXMQ25PAVE	FXMQ32PAVE	FXMQ40PAVE	FXMQ50PAVE	
Power supply	1-phase, 220-240 V/220 V, 50/60 Hz					
Cooling capacity	Btu/h	7,500	9,600	12,300	15,400	19,100
	kW	2.2	2.8	3.6	4.5	5.6
Heating capacity	Btu/h	8,500	10,900	13,600	17,100	21,500
	kW	2.5	3.2	4.0	5.0	6.3
Power consumption	Cooling	0.056 *1		0.060 *1	0.151 *1	0.128 *1
	Heating	0.044 *1		0.048 *1	0.139 *1	0.116 *1
Casing	Galvanised steel plate					
Airflow rate (HH/H/L)	ℓ/s	150/125/108		158/133/116	267/216/183	300/275/250
	m³/min	9/7.5/6.5		9.5/8/7	16/13/11	18/16.5/15
External static pressure	Pa	30-100 (50) *2			30-160 (100) *2	50-200 (100) *2
Sound level (HH/H/L)	dB(A)	33/31/29		34/32/30	39/37/35	41/39/37
Sound power (H)	dB(A)	51		52	57	59
Dimensions (H×W×D)	mm	300x550x700			300x700x700	300x1,000x700
Machine weight	kg	25			27	35
Piping connections	Liquid (Flare)	φ 6.4				
	Gas (Flare)	φ 12.7				
	Drain	VP25 (External Dia. 32/Internal Dia. 25)				

MODEL	FXMQ63PAVE	FXMQ80PAVE	FXMQ100PAVE	FXMQ125PAVE	FXMQ140PAVE	
Power supply	1-phase, 220-240 V/220 V, 50/60 Hz					
Cooling capacity	Btu/h	24,200	30,700	38,200	47,800	54,600
	kW	7.1	9.0	11.2	14.0	16.0
Heating capacity	Btu/h	27,300	34,100	42,700	54,600	61,400
	kW	8.0	10.0	12.5	16.0	18.0
Power consumption	Cooling	0.138 *1	0.185 *1	0.215 *1	0.284 *1	0.405 *1
	Heating	0.127 *1	0.173 *1	0.203 *1	0.272 *1	0.380 *1
Casing	Galvanised steel plate					
Airflow rate (HH/H/L)	ℓ/s	32.5/292/267	417/375/333	533/450/383	650/550/466	767/649/533
	m³/min	19.5/17.5/16	25/22.5/20	32/27/23	39/33/28	46/39/32
External static pressure	Pa	50-200 (100) *2				50-140 (100) *2
Sound level (HH/H/L)	dB(A)	42/40/38	43/41/39		44/42/40	46/45/43
Sound power (H)	dB(A)	60	61		62	64
Dimensions (H×W×D)	mm	300x1,000x700			300x1,400x700	
Machine weight	kg	35		45	46	
Piping connections	Liquid (Flare)	φ 9.5				
	Gas (Flare)	φ 15.9				
	Drain	VP25 (External Dia. 32/Internal Dia. 25)				

Notes: Specifications are based on the following conditions;  
 • Cooling: Indoor temp.: 27°CDB, 19°CWB, Outdoor temp.: 35°CDB, Equivalent piping length: 7.5 m, Height difference: 0 m.  
 • Heating: Indoor temp.: 20°CDB, Outdoor temp.: 7°CDB, 6°CWB, Equivalent piping length: 7.5 m, Height difference: 0 m.  
 • Capacity of indoor unit is only for reference. Actual capacity of indoor unit is based on the total capacity index. (See Engineering Data Book for details.)  
 • Sound level: Anechoic chamber conversion value, measured at a point 1.5 m downward from the unit centre. During actual operation, these values are normally somewhat higher as a result of ambient conditions.  
 \*1: Power consumption values are based on conditions of rated external static pressure.  
 \*2: External static pressure can be modified using a remote controller that offers seven (FXMQ20-32PA), thirteen (FXMQ40PA), fourteen (FXMQ50-125PA) or ten (FXMQ140PA) levels of control.  
 These values indicate the lowest and highest possible static pressures. The rated static pressure is 50 Pa for FXMQ20-32PA and 100 Pa for FXMQ40-140PA.

# High Static Pressure Duct Type

FXMQ-P

High static pressure allows for flexible duct design.



## Design flexibility

- Using a DC fan motor, the external static pressure can be controlled within a range of 50 Pa\* to 250 Pa\*.

Adjustable external static pressure

50 Pa 250 Pa

- \*60 Pa – 217 Pa for FXMQ160P
- \*50 Pa – 210 Pa for FXMQ180P
- \*50 Pa – 250 Pa for FXMQ200P-250P

## Easy installation

“Airflow rate auto adjustment function” at field setting  
(local setting by remote controller)

\*This function can only be set via wired remote controller.

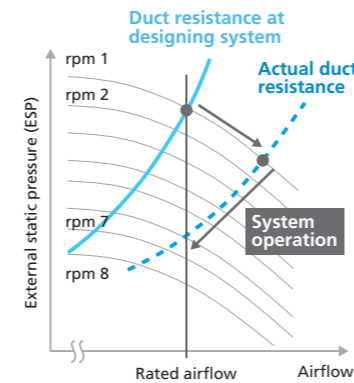
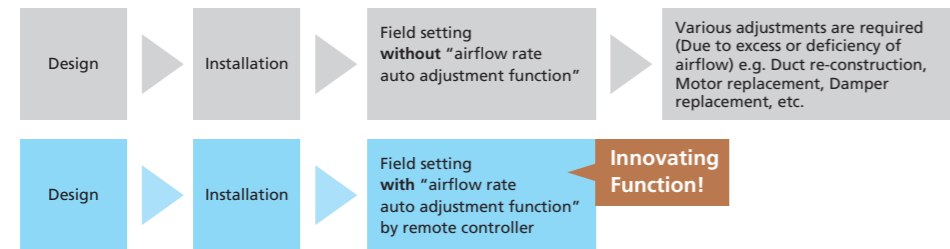

- <Mechanism>
- During field setting, power input of DC fan is detected.
  - External static pressure is estimated from power input of DC fan because PCB of FXMQ-P has table of external static pressure vs. power input of DC fan.
  - Actual duct resistance is calculated according to 1 and 2.
  - Fan speed is automatically adjusted to produce rated airflow.

Notes: “Airflow rate auto adjustment function” can be adjusted within ±10% of rated airflow. (Refer to Engineering Data Book for details)  
“Airflow rate auto adjustment function” should be used at field setting only.

- Drain pump kit is available as optional accessory with 750 mm lift.

- Each model can be separated into 2 sections for convenient handling and easier installation through openings in the ceiling.

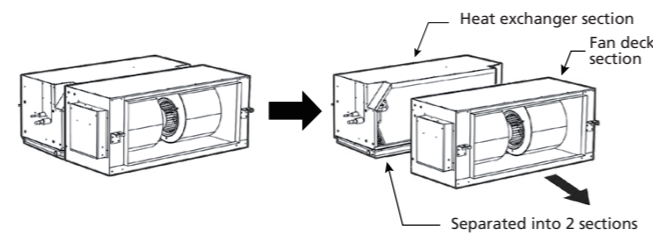

## Specifications

MODEL		FXMQ160PV1A	FXMQ180PV1A	FXMQ200PV1A	FXMQ250PV1A
Power supply		1-phase, 220-240 V, 50 Hz			
Cooling capacity	Btu/h	61,400	68,200	76,400	95,500
	kW	18.0	20.0	22.4	28.0
Heating capacity	Btu/h	68,200	76,400	85,300	107,500
	kW	20.0	22.4	25.0	31.5
Power consumption*1	Cooling	0.650		0.640	0.810
	Heating	0.650		0.640	0.810
Casing		Galvanized steel plate			
Airflow rate (HH/H/L)	ℓ/s	1,120/955/790	1,160/995/820	1,200/1,025/850	1,400/1,200/1,000
	m³/min	67.2/57.3/47.4	69.6/59.7/49.2	72.0/61.5/51.0	84.0/72.0/60.0
External static pressure*2	Pa	60-217 (138)	50-210 (130)	50-250 (150)	
Sound level (HH/H/L)	dB(A)	45/41.5/38		44/40.5/37	46/42.5/39
Sound power (H)	dB(A)	73		72	74
Dimensions (H×W×D)	mm	470x1,133x919		470x1,333x919	
Machine weight	kg	70		79	85
Piping connections	Liquid	φ 9.5 (Flare)	φ 9.5 (Brazing)		
	Gas	φ 15.9 (Flare)	φ 19.1 (Brazing)		φ 22.2 (Brazing)
	Drain	BSP 3/4 internal thread (OD φ 32.7)			

- Notes: Specifications are based on the following conditions;
- Cooling: Indoor temp.: 27°CDB, 19°CWB, Outdoor temp.: 35°CDB, Equivalent piping length: 7.5 m, Height difference: 0 m.
  - Heating: Indoor temp.: 20°CDB, Outdoor temp.: 7°CDB, 6°CDB, Equivalent piping length: 7.5 m, Height difference: 0 m
  - Capacity of indoor unit is only for reference. Actual capacity of indoor unit is based on the total capacity index. (See Engineering Data Book for details.)
  - Sound level: Anechoic chamber conversion value, measured at a point 1.5 m downward from the unit centre.
- During actual operation, these values are normally somewhat higher as a result of ambient conditions.
- \*1: Power consumption values are based on conditions of rated external static pressure.  
\*2: These values indicate the lowest and highest possible static pressures. The rated static pressure is 138 Pa for FXMQ160P, 130 Pa for FXMQ180P and 150 Pa for FXMQ200-250P.



# 4-way Flow Ceiling Suspended Type

## FXUQ-A

Slim and stylish design, optimum air distribution, installation without ceiling cavity



## Slim and stylish design

- Unit body and suction panel have round shapes that form a slim design, that fits various locations such as the ceilings without cavity.
- Flaps close automatically when the unit stops, which gives a simple appearance.
- All models have a unified slim height of 198 mm that gives a similar impression even when models with different capacities are installed in the same area.

## Comfort

- Airflow direction adjustment can be individually adjusted for each air discharge outlet to deliver optimal air distribution. 5 directions of airflow and auto-swing can be selected with BRC1E63 or BRC1H63W(K).
- Control of the airflow rate can be selected from 3-step control. Auto airflow rate control can be selected with wired remote controller.

## Flexible installation

- Drain pump is equipped as a standard accessory with 600 mm lift.
- Depending on installation site requirements or room conditions, 2-way, 3-way and 4-way discharge patterns are available.

4-way flow

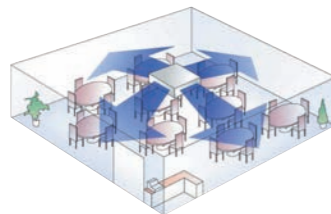

3-way flow

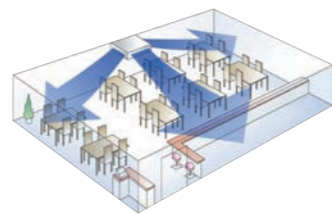

L-shaped 2-way flow

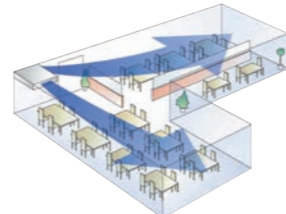

## Cleanliness

### Silver ion anti-bacterial drain pan

- Prevents the growth of slime, bacteria, and mould that cause odours and clogging.

\* Drain pan should be changed once every two to three years.



### Filter has anti-mould and antibacterial treatment



## Specifications

MODEL		FXUQ71AVEB	FXUQ100AVEB
Power supply		1-phase, 220-240 V/220-230 V, 50/60 Hz	
Cooling capacity	Btu/h	27,300	38,200
	kW	8.0	11.2
Heating capacity	Btu/h	30,700	42,700
	kW	9.0	12.5
Power consumption	Cooling	0.090	0.200
	Heating	0.073	0.179
Casing		Fresh white	
Airflow rate (H/M/L)	ℓ/s	375/325/267	517/433/350
	m <sup>3</sup> /min	22.5/19.5/16	31/26/21
Sound level (H/M/L)	dB(A)	40/38/36	47/44/40
Sound power (H/M/L)	dB(A)	58/56/54	65/62/58
Dimensions (HxWxD)	mm	198x950x950	
Machine weight	kg	26	27
Piping connections	Liquid (Flare)	φ 9.5	
	Gas (Flare)	φ 15.9	
	Drain	VP20 (External Dia. 26/Internal Dia. 20)	

### Notes:

Specifications are based on the following conditions;

- Cooling: Indoor temp.: 27°CDB, 19°CWB, Outdoor temp.: 35°CDB, Equivalent piping length: 7.5 m, Height difference: 0 m.
- Heating: Indoor temp.: 20°CDB, Outdoor temp.: 7°CDB, 6°CWB, Equivalent piping length: 7.5 m, Height difference: 0 m.
- Capacity of indoor unit is only for reference. Actual capacity of indoor unit is based on the total capacity index. (See Engineering Data Book for details.)
- Sound level: Anechoic chamber conversion value, measured at a point 1 m in front of the unit and 1 m downward. During actual operation, these values are normally somewhat higher as a result of ambient conditions

# Ceiling Suspended Type

**New** FXHQ-MA / B

FXHQ50 / 80MA  
FXHQ32 / 63 / 100MA

**New** FXHQ125 / 140B

Slim body with quiet and wide airflow



## Comfort

- Auto swing (up and down) and louvers (left and right by hand) bring comfort to the room.
- Louver manually adjusts for straight or wide angle airflow.

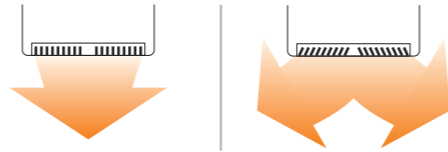

## Installation flexibility

- Flexible installation  
The unit fits more snugly into tight spaces.
- Drain pump kit (option) can be easily incorporated.  
Drain pipe connection can be done inside the unit.  
Refrigerant and drain pipe outlets are at the same opening.
- All wiring and internal servicing can be done from under the unit.

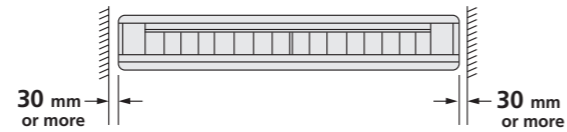

\*Water used in the test-run can be drained from the air discharge opening rather than from the side as was formerly the case.

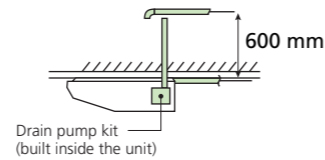

## New 125 / 140 models provide greater capacity for large spaces

- The technology of the DC fan motor, wide sirocco fan, and large heat exchanger combine for greater airflow and quiet operation.
- Sophisticated design: Flap neatly closes when not in use.
- Suitable for high ceilings: maximum 4.3 m
- Control of the airflow rate can be selected from 3-step control.
- Drain pump kit (option) includes a silver ion antibacterial agent that assists in preventing the growth of slime, bacteria, and mould that cause smells and clogging.
- The rear side removable frame allows ease of access for piping work.

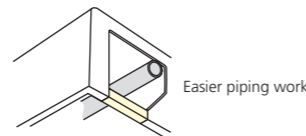

## Cleanliness

**New** Streamer filter clean unit (Option) for new 125 / 140 models See page 5-6

Daikin Streamer technology enhances maximum efficiency in cleaning, which uses powerful decomposition properties to decompose substances captured by the filter for better air quality.



BAPW55A61

Remarks:

- 1) Only the stylish remote controller BRC1H63W(K) can be connected for ON/OFF operation of the streamer.
- 2) The Streamer function operates only when the fan and air conditioning operation are stopped. The maximum operation of Streamer is 180 minutes per day.



## Specifications

MODEL		FXHQ32MAVE	FXHQ50MAVE	FXHQ63MAVE	FXHQ80MAVE	FXHQ100MAVE	FXHQ125BVM	FXHQ140BVM	
Power supply		1-phase, 220-240 V/220 V, 50/60 Hz					1-phase, 220-240 V/220-230 V, 50/60 Hz		
Cooling capacity	Btu/h	12,300	19,100	24,200	30,700	38,200	48,000	52,900	
	kW	3.6	5.6	7.1	9.0	11.2	14.1	15.5	
Heating capacity	Btu/h	13,600	21,500	27,300	34,100	42,700	54,600	58,000	
	kW	4.0	6.3	8.0	10.0	12.5	16.0	17.0	
Power consumption	Cooling	0.111	0.100	0.115	0.126	0.135	0.168	0.181	
	Heating	0.111	0.100	0.115	0.126	0.135	0.168	0.181	
Casing		Sheet Metal / White (10Y9/0.5)					Sheet Metal / White		
Airflow rate (H/M/L)	ℓ/s	200/-/166	250/-/200	291/-/233	392/-/283	416/-/325	567/433/333	600/450/333	
	m <sup>3</sup> /min	12/-/10	15/-/12	17.5/-/14	23.5/-/17	25/-/19.5	34/26/20	36/27/20	
Sound level (H/M/L)	dB(A)	36/-/31	37/-/32	39/-/34	43/-/35	45/-/37	46/41/37	48/42/37	
Dimensions (H × W × D)	mm	195×960×680	195×1,160×680		195×1,400×680		235×1,590×690		
Machine weight	kg	24	28		33		41		
Piping connections	Liquid (Flare)	φ 6.4			φ 9.5				
	Gas (Flange)	φ 12.7			φ 15.9				
	Drain	VP20 (External Dia. 26/Internal Dia. 20)							

Notes: Specifications are based on the following conditions;

- Cooling: Indoor temp.: 27°CDB, 19°CWB, Outdoor temp.: 35°CDB, Equivalent piping length: 7.5 m, Height difference: 0 m.
- Heating: Indoor temp.: 20°CDB, Outdoor temp.: 7°CDB, 6°CWB, Equivalent piping length: 7.5 m, Height difference: 0 m.
- Capacity of indoor unit is only for reference. Actual capacity of indoor unit is based on the total capacity index. (See Engineering Data Book for details.)
- Sound level: Anechoic chamber conversion value, measured at a point 1 m in front of the unit and 1 m downward.  
During actual operation, these values are normally somewhat higher as a result of ambient conditions.



# Wall Mounted Type

## FXAQ-A

Stylish flat panel design harmonised with your interior décor

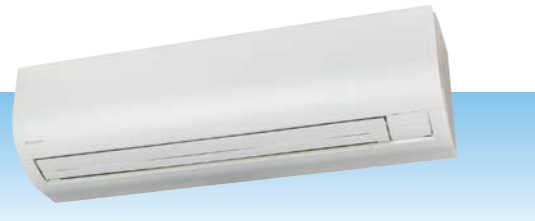

## Comfort

### Higher airflow



- An invisible air intake at the top of the unit
- Vertical auto-swing enables efficient air and temperature distribution throughout the room.
- The louver closes automatically when the unit stops.
- Enhanced comfort is achieved.
- 5 step discharge angles can be set by remote controller.
- Discharge angle is automatically set at the same angle as previous operation when restart.

### Lower sound level

- Whisper quiet in operation, with sound levels as low as 28.5 dB(A)\*  
\*Sound level for FXAQ20-32A
- An ideal solution for a wide range of commercial spaces, including individual office spaces.

## Stylish design and cleanliness

- Stylish flat panel design creates a graceful harmony that enhances any interior space.
- Flat panel can be cleaned with only the single pass of a cloth across their smooth surface. Flat panel can also be easily removed and washed for more thorough cleaning.
- Drain pan and air filter can be kept clean by mould-proof polystyrene.

## Flexible installation

- Drain pipe can be fitted to from either left or right sides.
- Drain pump kit is available as optional accessory, which lifts the drain 1,000 mm from the bottom of the unit.

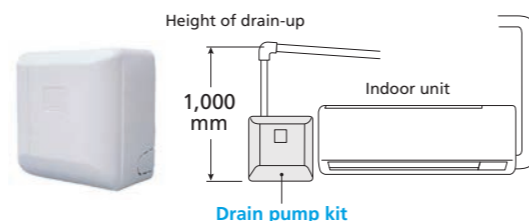

### External EV kit (for heating operation) (Option)

This product, which is concealed in ceilings or corridors for quieter heating operation, is used to connect indoor units in places where quiet environment is required such as residential living rooms.

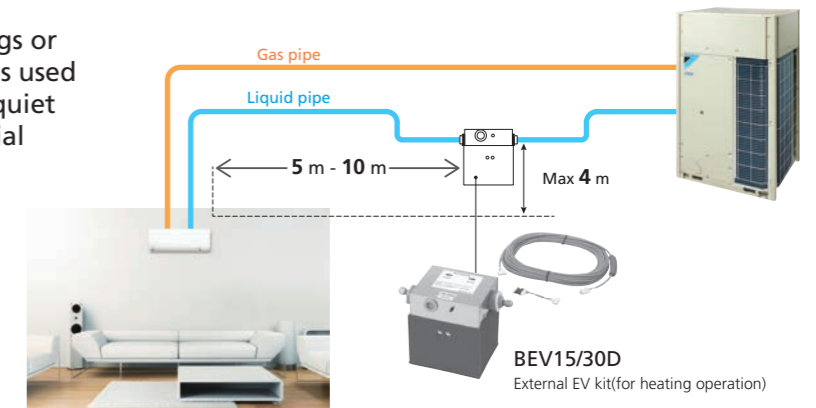

\* This option is only effective for reducing operation sound during heating operation. Therefore it is ineffective when connected to cooling only outdoor units.

## Specifications

MODEL		FXAQ20AVM	FXAQ25AVM	FXAQ32AVM	FXAQ40AVM	FXAQ50AVM	FXAQ63AVM
Power supply		1-phase, 220-240 V/220-230 V, 50/60 Hz					
Cooling capacity	Btu/h	7,500	9,600	12,300	15,400	19,100	24,200
	kW	2.2	2.8	3.6	4.5	5.6	7.1
Heating capacity	Btu/h	8,500	10,900	13,600	17,100	21,500	27,300
	kW	2.5	3.2	4.0	5.0	6.3	8.0
Power consumption	Cooling	0.040	0.040	0.040	0.050	0.060	0.100
	Heating	0.040	0.040	0.050	0.050	0.070	0.110
Casing		Resin / White N9.5					
Airflow rate (H/L)	ℓ/s	151/116	156/116	163/116	203/161	250/200	316/233
	m <sup>3</sup> /min	9.1/7.0	9.4/7.0	9.8/7.0	12.2/9.7	15.0/12.0	19.0/14.0
Sound level (H/L)	Cooling	33.0/28.5	35.0/28.5	37.5/28.5	37.0/33.5	41.0/35.5	46.5/38.5
	Heating	34.0/28.5	36.0/28.5	38.5/28.5	38.0/33.5	42.0/35.5	47.0/38.5
Dimensions (H x W x D)		290x795x266			290x1,050x269		
Machine weight		12			15		
Piping connections	Liquid (Flare)	φ 6.4					φ 9.5
	Gas (Flange)	φ 12.7					φ 15.9
	Drain	VP13 (External Dia. 18/Internal Dia. 15)					

Notes: Specifications are based on the following conditions;  
 • Cooling: Indoor temp.: 27°CDB, 19°CWB, Outdoor temp.: 35°CDB, Equivalent piping length: 7.5 m, Height difference: 0 m.  
 • Heating: Indoor temp.: 20°CDB, Outdoor temp.: 7°CDB, 6°CWB, Equivalent piping length: 7.5 m, Height difference: 0 m.  
 • Capacity of indoor unit is only for reference. Actual capacity of indoor unit is based on the total capacity index. (See Engineering Data Book for details.)  
 • Sound level: Anechoic chamber conversion value, measured at a point 1 m in front of the unit and 1 m downward. During actual operation, these values are normally somewhat higher as a result of ambient conditions.

# Floor Standing Type

## FXLQ-MA

Suitable for perimeter zone air conditioning



- Floor Standing types can be hung on the wall for easier cleaning. Running the piping from the back allows the unit to be hung on walls. Cleaning under the unit, where dust tends to accumulate, is considerably easier.
- The adoption of a fibre-less discharge grille featuring an original design to prevent condensation also helps prevent staining and makes cleaning easier.
- A long-life filter (maintenance free up to one year\*) is equipped as standard accessory.

\*8 hr/day, 25 day/month. For dust concentration of 0.15 mg/m<sup>3</sup>

### Specifications

MODEL		FXLQ20MAVE	FXLQ25MAVE	FXLQ32MAVE	FXLQ40MAVE	FXLQ50MAVE	FXLQ63MAVE
Power supply		1-phase, 220-240 V/220 V, 50/60 Hz					
Cooling capacity	Btu/h	7,500	9,600	12,300	15,400	19,100	24,200
	kW	2.2	2.8	3.6	4.5	5.6	7.1
Heating capacity	Btu/h	8,500	10,900	13,600	17,100	21,500	27,300
	kW	2.5	3.2	4.0	5.0	6.3	8.0
Power consumption	Cooling	0.049		0.090		0.110	
	Heating	0.049		0.090		0.110	
Casing		Ivory white (5Y7.5/1)					
Airflow rate (H/L)	ℓ/s	116/100		133/100	183/141	233/183	266/200
	m <sup>3</sup> /min	7/6		8/6	11/8.5	14/11	16/12
Sound level (H/L)	240 V	37/34		40/35	41/36	42/37	
Dimensions (H × W × D)		600×1,000×222		600×1,140×222		600×1,420×222	
Machine weight		25		30		36	
Piping connections	Liquid (Flare)	φ 6.4				φ 9.5	
	Gas (Flare)	φ 12.7				φ 15.9	
	Drain	210.D.					

Notes: Specifications are based on the following conditions;

- Cooling: Indoor temp.: 27°CDB, 19°CWB, Outdoor temp.: 35°CDB, Equivalent piping length: 7.5 m, Height difference: 0 m.
- Heating: Indoor temp.: 20°CDB, Outdoor temp.: 7°CDB, 6°CWB, Equivalent piping length: 7.5 m, Height difference: 0 m.
- Capacity of indoor unit is only for reference. Actual capacity of indoor unit is based on the total capacity index. (See Engineering Data Book for details.)
- Sound level: Anechoic chamber conversion value, measured at a point 1.5 m in front of the unit at a height of 1.5 m. During actual operation, these values are normally somewhat higher as a result of ambient conditions.

# Concealed Floor Standing Type

## FXNQ-MA

Designed to be concealed in the perimeter skirting-wall



- The unit is concealed in skirting-wall of perimeter, that enables to create high class interior design.
- The connecting port faces downward, greatly facilitating on-site piping work.
- A long-life filter (maintenance free up to one year\*) is equipped as standard accessory.

\*8 hr/day, 25 day/month. For dust concentration of 0.15 mg/m<sup>3</sup>

### Specifications

MODEL		FXNQ20MAVE	FXNQ25MAVE	FXNQ32MAVE	FXNQ40MAVE	FXNQ50MAVE	FXNQ63MAVE
Power supply		1-phase, 220-240 V/220 V, 50/60 Hz					
Cooling capacity	Btu/h	7,500	9,600	12,300	15,400	19,100	24,200
	kW	2.2	2.8	3.6	4.5	5.6	7.1
Heating capacity	Btu/h	8,500	10,900	13,600	17,100	21,500	27,300
	kW	2.5	3.2	4.0	5.0	6.3	8.0
Power consumption	Cooling	0.049		0.090		0.110	
	Heating	0.049		0.090		0.110	
Casing		Galvanised steel plate					
Airflow rate (H/L)	ℓ/s	116/100		133/100	183/141	233/183	266/200
	m <sup>3</sup> /min	7/6		8/6	11/8.5	14/11	16/12
Sound level (H/L)	240 V	37/34		40/35	41/36	42/37	
Dimensions (H × W × D)		610×930×220		610×1,070×220		610×1,350×220	
Machine weight		19.0		23.0		27.0	
Piping connections	Liquid (Flare)	φ 6.4				φ 9.5	
	Gas (Flare)	φ 12.7				φ 15.9	
	Drain	210.D.					

Notes: Specifications are based on the following conditions;

- Cooling: Indoor temp.: 27°CDB, 19°CWB, Outdoor temp.: 35°CDB, Equivalent piping length: 7.5 m, Height difference: 0 m.
- Heating: Indoor temp.: 20°CDB, Outdoor temp.: 7°CDB, 6°CWB, Equivalent piping length: 7.5 m, Height difference: 0 m.
- Capacity of indoor unit is only for reference. Actual capacity of indoor unit is based on the total capacity index. (See Engineering Data Book for details.)
- Sound level: Anechoic chamber conversion value, measured at a point 1.5 m in front of the unit at a height of 1.5 m. During actual operation, these values are normally somewhat higher as a result of ambient conditions.



# BS Units

## BS Units for Heat Recovery

### BS unit (Single type/Multi type)

By adding suction gas piping and a BS unit (sold separately), simultaneous cooling and heating operation can be provided by a single system.

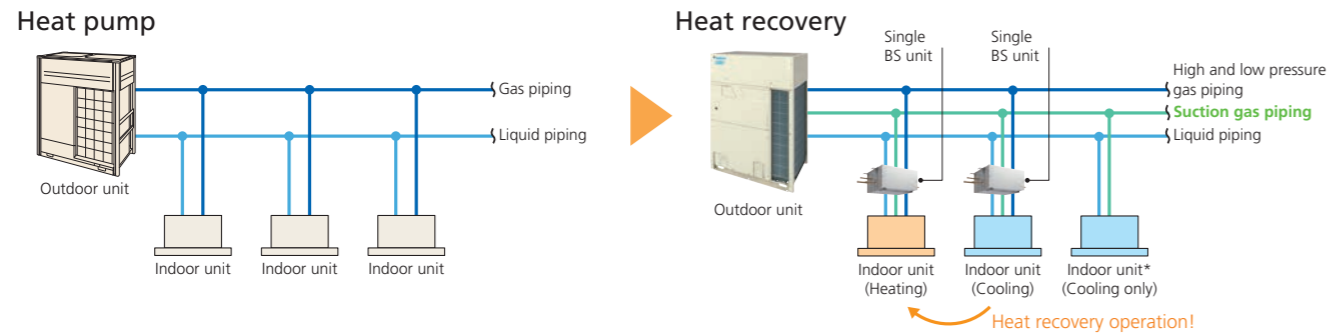
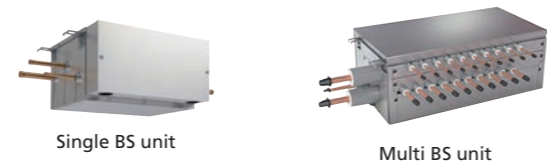

\* For indoor units used for cooling only (do not connect to BS unit when using for heat recovery), total capacity index must be 50% or less than the capacity index of the outdoor units.

### Application reference

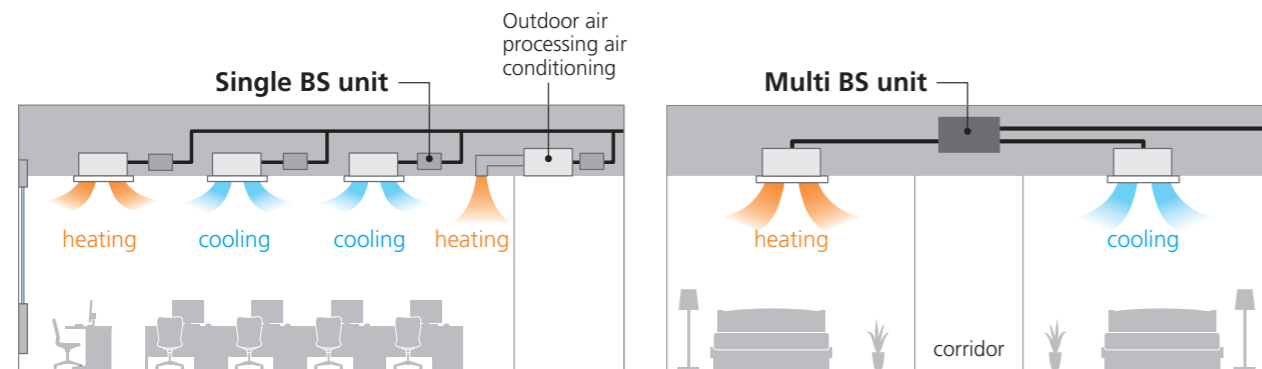

#### Winter season (Office Building)

- Difference between the load of cold air and heat from room is large
- Can be used with the outdoor air processing air conditioning

#### Winter season (Hotel)

- Able to cater to individual heating and cooling requirement

## BS Unit Lineup

### Single and multi BS unit allow greater design flexibility

#### Single BS unit



**Drainless Type**  
BSQ100AVE  
BSQ160AVE  
BSQ250AVE

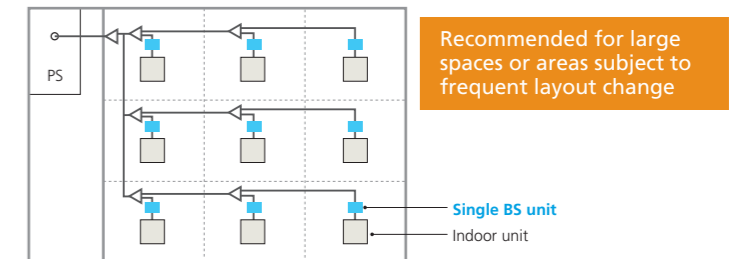

- No need for drain piping
  - Easy installation
  - Less risk of water leakage
- Compact and flexible installation
- Flexible design
- Low noise

#### Specifications — Single BS Unit

MODEL					
		BSQ100AVE	BSQ160AVE	BSQ250AVE	
Power supply		1-phase, 220-240/220 V, 50/60 Hz			
No. of branches		1			
Total capacity index of connectable indoor units		20 to 100	More than 100 but 160 or less	More than 160 but 250 or less	
No. of connectable indoor units		Max. 5	Max. 8	Max. 8	
Casing		Galvanised steel plate			
Dimensions (HxWxD)		207x388x326			
Piping connections	Indoor Unit	Liquid	φ9.5 (Brazeing) * <sup>1</sup>	φ9.5 (Brazeing)	φ9.5 (Brazeing)
		Gas	φ15.9 (Brazeing) * <sup>1</sup>	φ15.9 (Brazeing) * <sup>2</sup>	φ22.2 (Brazeing) * <sup>3</sup>
	Outdoor Unit	Liquid	φ9.5 (Brazeing)	φ9.5 (Brazeing)	φ9.5 (Brazeing)
		Suction gas	φ15.9 (Brazeing)	φ15.9 (Brazeing) * <sup>2</sup>	φ22.2 (Brazeing) * <sup>3</sup>
	High and low pressure gas	φ12.7 (Brazeing)	φ12.7 (Brazeing) * <sup>2</sup>	φ19.1 (Brazeing) * <sup>3</sup>	
Machine weight		kg	11	11	14
Sound level		dB(A)	35(40) * <sup>4</sup>	41(45) * <sup>4</sup>	41(45) * <sup>4</sup>

- Note: ★ 1. When connecting with an indoor unit with a capacity index between 20 and 50, connect the attached pipe to the field pipe. (Braze the connection between the attached and field pipe.)  
 ★ 2. When connecting with indoor units with total capacity indexes 150 or more and 160 or less, connect the attached pipe to the field pipe. (Braze the connection between the attached and field pipe.)  
 ★ 3. When connecting with indoor units with a capacity index of 200, or with total capacity indexes more than 160 and less than 200, connect the attached pipe to the field pipe. (Braze the connection between the attached and field pipe.)  
 ★ 4. Figures in brackets ( ) indicate maximum value of transient sound (the change of cooling and heating).  
 • Do not install at the place such as bed room. Small sound of refrigerant will be made, which may be disturbing.

## Multi BS unit



### Drainless Type

- BS4Q14BVM (4-branch)
- BS6Q14BVM (6-branch)
- BS8Q14BVM (8-branch)
- BS10Q14BVM (10-branch)
- BS12Q14BVM (12-branch)

### Standard Type

- BS16Q14AVM (16-branch)

### ■ No need for drain piping (Drainless type only)

- Easy installation
- Less risk of water leakage

### ■ Wide range lineup

- Max. 16 branches with a single unit up to 30 class

### ■ Individual control and cooling/heating changeover for each branch

### ■ Installation cost reduction by reduction of brazing points.

## Drainless function enables a drastic reduction of on-site work

Drain is eliminated with the use of foam insulation inside the casing.

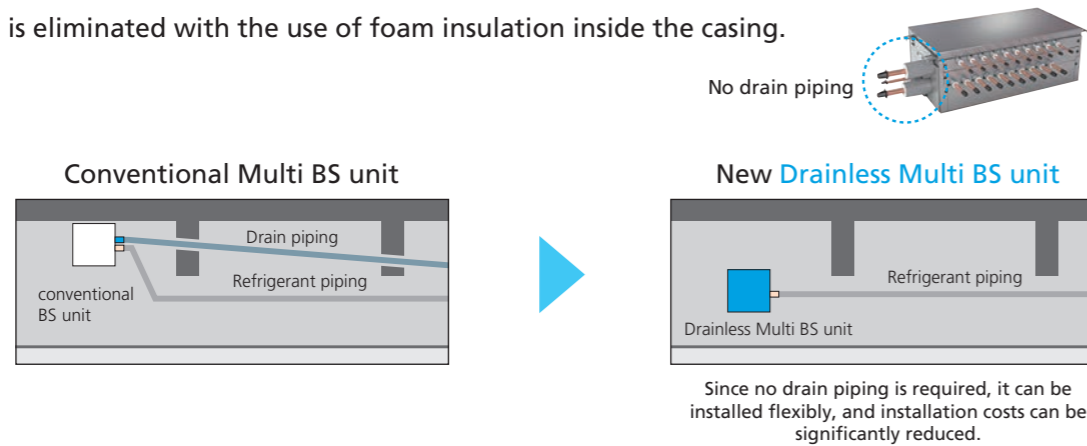

## Specifications — Multi BS Unit

MODEL	BS4Q14BVM		BS6Q14BVM		BS8Q14BVM		BS10Q14BVM		BS12Q14BVM		BS16Q14AVM		
	Power supply	1-phase, 220-240 V / 220-230 V, 50 / 60 Hz											
No. of branches	4		6		8		10		12		16		
Capacity index of connectable indoor units of branch	Max. 140												
Capacity index of connectable indoor units	Max. 400		Max. 600		Max. 750		Max. 750		Max. 750		Max. 750		
No. of connectable indoor units per branch	5												
Casing	Galvanised steel plate												
Dimensions (HxWxD)	mm 298x370x480		mm 298x580x480				mm 298x820x480				mm 298x1060x430		
Piping connections	Indoor Unit	Liquid	mm $\phi 6.4, \phi 9.5$ Brazing <sup>★1</sup>										
		Gas	mm $\phi 12.7, \phi 15.9$ Brazing <sup>★1</sup>										
	Outdoor Unit	Liquid	$\phi 9.5$ Brazing <sup>★2</sup>	$\phi 12.7$ Brazing <sup>★2</sup>	$\phi 12.7$ Brazing ( $\phi 15.9$ ) <sup>★2</sup>	$\phi 15.9$ Brazing <sup>★2</sup>	$\phi 15.9$ Brazing ( $\phi 19.1$ ) <sup>★2</sup>	$\phi 19.1$ Brazing <sup>★2</sup>					
		Suction gas	$\phi 22.2$ Brazing ( $\phi 19.1$ ) <sup>★2</sup>	$\phi 28.6$ Brazing <sup>★2</sup>		$\phi 28.6$ Brazing ( $\phi 34.9$ ) <sup>★2</sup>		$\phi 34.9$ Brazing <sup>★2</sup>					
High and low pressure gas	$\phi 19.1$ Brazing ( $\phi 15.9$ ) <sup>★2</sup>	$\phi 19.1$ Brazing ( $\phi 22.2$ ) <sup>★2</sup>	$\phi 19.1$ Brazing ( $\phi 22.2, 28.6$ ) <sup>★2</sup>	$\phi 28.6$ Brazing <sup>★2</sup>									
Machine weight	kg	22		31		33		46		48		50	
Sound level	dB(A)	38(45) <sup>★3</sup>		39(47) <sup>★3</sup>		40(48) <sup>★3</sup>		40(48) <sup>★3</sup>		41(49) <sup>★3</sup>		41(49) <sup>★3</sup>	
Drain pipe size	mm	Not necessary										VP20 (External Dia. 26 / Internal Dia. 20)	

- Note: <sup>★1</sup> When connecting with an indoor unit with a capacity index between 20 and 50, connect the attached pipe to the field pipe. (Brazing connection between the attached and field pipe.) In case of others, cut the outlet pipe and connect to the connecting pipe.
- <sup>★2</sup> Reducer may be required (obtain locally) if joint diameter does not fit on the triple piping side. Figures in brackets ( ) is the size when using the attached reducer. Insulators are necessary (obtain locally) for piping connections on the outdoor unit side.
- <sup>★3</sup> Figures in brackets ( ) indicate maximum value of transient sound (the change of cooling and heating).  
 • Must be installed in locations where the noise generated by the BS unit does not cause any problem.

## Multi BS units significantly reduce installation work and construction costs

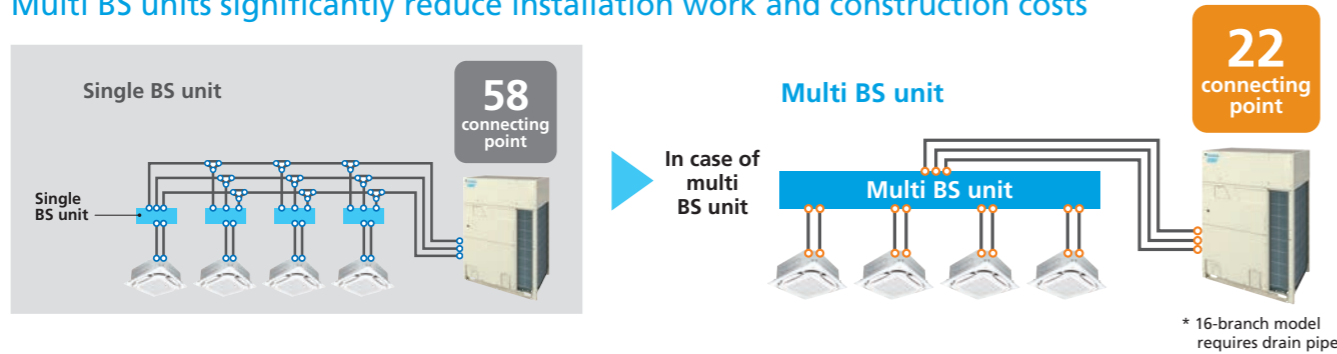

## Greater design flexibility achieved by increasing the connection capacity range

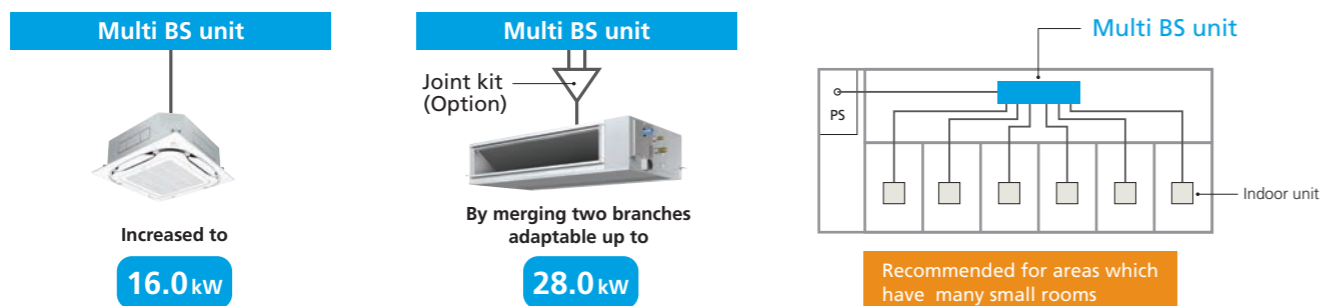



# Air Handling Unit

Integrate your air handling unit in a total solution for large size spaces such as factories and large stores.

- Easy design and installation  
The system is easy to design and install since no additional water systems such as boilers, tanks and gas connections etc are required.
- Inverter controlled units
- Control of air temperature via standard Daikin wired remote control for standard series



AHUR  
Capacity range : 6 – 60 class

## System overview

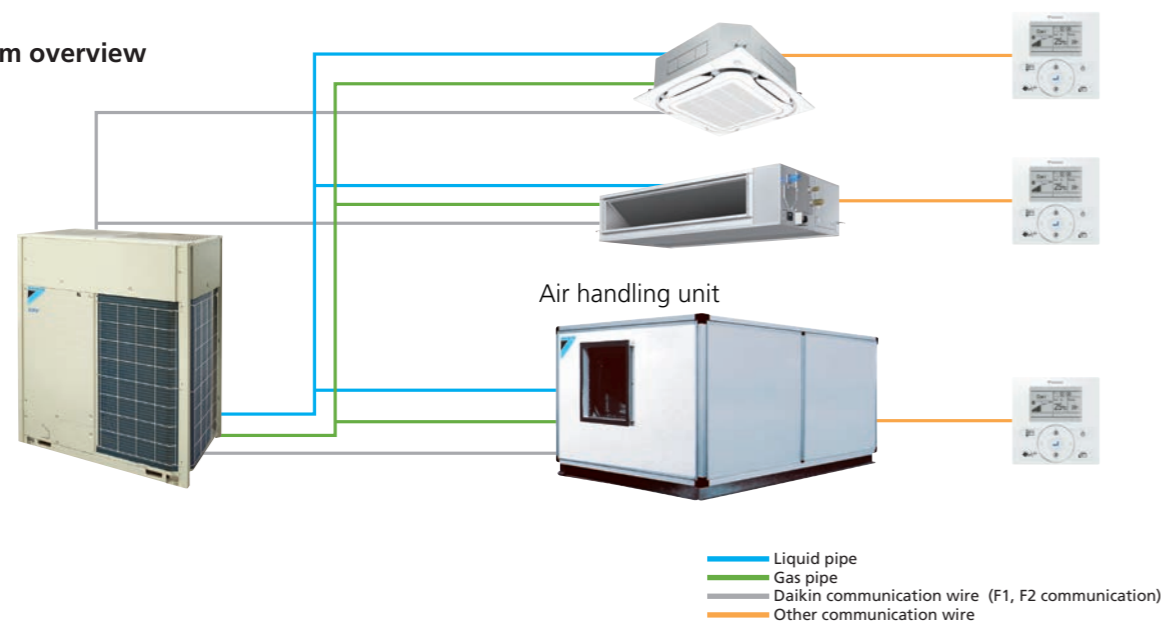

Daikin air handling units can be connected to **VRV** systems. This combination can be built to order as a system. Outdoor air series is also possible. Please contact your local sales office for details.



# Air Treatment Equipment

Daikin's air treatment systems creating a higher IAQ

Components of indoor air quality

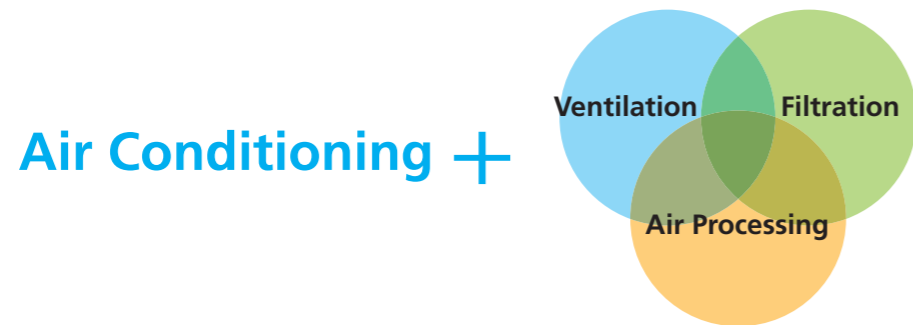

A recent trend rapidly gaining popularity is for air treatment to be required as well as air conditioning. Daikin has a lineup of 3 products that provide adequate IAQ, according to the client's needs.

## Our Solutions for Indoor Air Quality Problems

You may think cool and comfortable air-conditioned room is enough, but...

**1** If the windows are closed in an air-conditioned room

Virus and CO<sub>2</sub> will accumulate in the room.

**2** But if you open the windows...

PM2.5 and humidity will come in, and it will become hot.

**3** Let's close the windows and turn on the air purifier!

Air conditioning regulates heat and humidity, and air purifier can remove PM2.5, but CO<sub>2</sub> remains high. It is hard to concentrate.

**4** If you have mechanical ventilation system such as Heat Reclaim Ventilator...

Finally, the CO<sub>2</sub> has been removed, and a comfortable space has been achieved!

Ventilation equipment can be selected according to suit purpose and circumstances

	Outdoor Air Processing Unit		Heat Reclaim Ventilator
	FXMQ-MF series	FXMQ-AF series	VAM-H series
Connections with VRV systems	Refrigerant Piping	Connectable	Not connectable
	Wiring	Connectable	Connectable
	After-cool & After-heat Control	Available	Not available
Ventilation class	Class 2	Class 2	Class 1
	Air supply only	Air supply only	Air supply & air exhaust
Heat Exchange Element	—	—	Energy savings obtained
High Efficiency Filter (Option)	Available	—	Available
PM2.5 Filter (Option)	—	—	Available
MERV8/14 Filter (Option)	—	Available	—
Airflow Rate	1,080 - 2,100 m <sup>3</sup> /h	690 - 2,160 m <sup>3</sup> /h	150 - 2,000 m <sup>3</sup> /h

\*1. Optional filter is necessary. Refer to option list for details.  
\*2. Refers to bringing outdoor air to near indoor temperature and delivering to a room.

## Ventilation class

Class 1 Ventilation	Class 2 Ventilation	Class 3 Ventilation
Installing a Heat Reclaim Ventilator enables mechanical ventilation to control both air supply and air exhaust while ensuring continuous room comfort through the supply of temperature-controlled air.	Mechanical ventilation is used for air supply, and natural ventilation is used for air exhaust. This prevents dirty outdoor air from entering and maintains a clean environment even for large spaces.	Natural ventilation is used for air supply, and mechanical ventilation is used for air exhaust. Odours and steam generated indoors are eliminated before spreading to other areas.



# Air Treatment Equipment

## Outdoor-Air Processing Unit (Discharge Air Temperature Control Type)

### FXMQ-MF Series

Combine fresh air treatment and air conditioning, supplied from a single system.

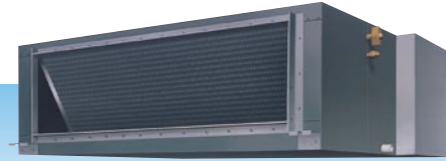

Fresh air treatment and air conditioning can be achieved with a single system. VRF indoor units for air conditioning and an outdoor-air processing unit can be connected to the same refrigerant line.

#### Lineup

Model Name	FXMQ125MFV1	FXMQ200MFV1	FXMQ250MFV1
Capacity index	125	200	250
Airflow rate	1,080 m <sup>3</sup> /h	1,680 m <sup>3</sup> /h	2,100 m <sup>3</sup> /h

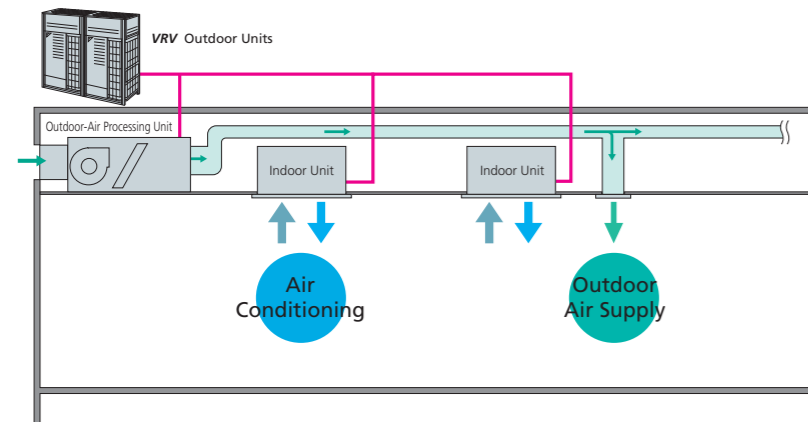

#### Connection Conditions

- Outdoor-air processing units can be used without indoor units. The total connection capacity index must be 50% to 100% of the capacity index of the outdoor units.
- When outdoor-air processing units and standard indoor units are combined, the total connection capacity index of the outdoor-air processing units must not exceed 30% of the capacity index of the outdoor units. Because connection is possible depending on conditions even when the capacity index of outdoor-air processing units exceeds 30% of the capacity index of the outdoor units, contact your local distributor.

### Outdoor-air processing / Discharge air temperature control

The unit supplies outdoor fresh air controlling discharge air temperature from the unit.

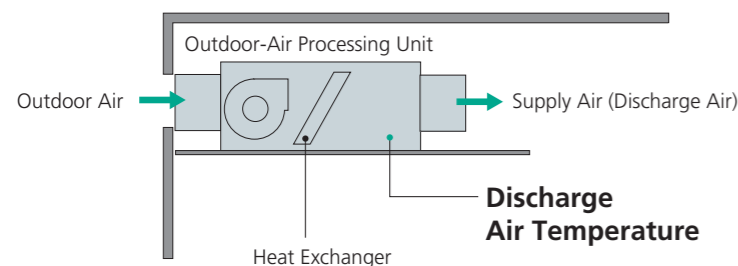

- \* The default setting of the discharge air temperature is 18°C for cooling operation, and 25°C for heating operation.
- \* While in unit protection mode and depending on outdoor air conditions, discharge air temperature may not be at the set temperature.
- \* The fan stops in defrosting, oil returning and hot start operations due to mechanical protection control.

### Operation range

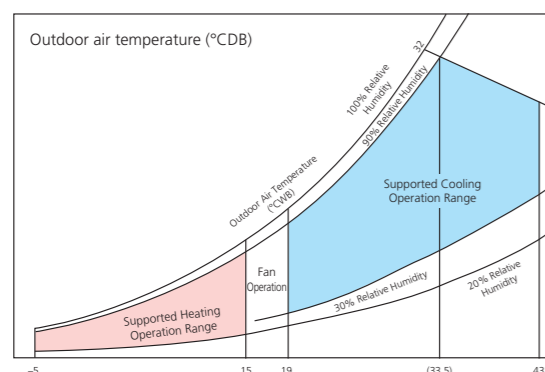

Applicable to outdoor air temperature range from -5 to 43°C. In cooling operation, 19 to 43°C is adoptable.

- Notes:
1. The operation range shown in the graph is under the following conditions. Equivalent piping length: 7.5 m, Height difference: 0 m.
  2. The system will not operate in fan mode when the outdoor air temperature is 5°C or below.

#### Precautions for use of FXMQ-MF series

1. This unit is intended for the treatment of outdoor air only. Not to be used for maintaining indoor air temperature. Be sure that the discharge airflow will not blow on people directly.
2. Group control of the product and standard indoor units is not supported. A separate remote controller should be connected to individual unit.
3. If the unit is utilised to operate 24 hours a day, maintenance (part replacement, etc.) must be performed periodically.
4. Temperature setting and Power Proportional Distribution (PPD) are not possible even if the intelligent Touch Controller or the intelligent Touch Manager is installed.
5. The remote controller wired to the outdoor-air processing unit must not be set as the master remote controller. Otherwise, when set to "Auto," the operation mode will switch according to the outdoor air conditions, regardless of the indoor temperature.

### Specifications

Type	MODEL	Ceiling Mounted Duct Type			
		FXMQ125MFV1	FXMQ200MFV1	FXMQ250MFV1	
Power supply		1-phase 220-240 V, 50 Hz			
Cooling capacity *1	Btu/h	47,800	76,400	95,500	
	kW	14.0	22.4	28.0	
Heating capacity *1	Btu/h	30,400	47,400	59,400	
	kW	8.9	13.9	17.4	
Power consumption	kW	0.359	0.548	0.638	
Casing		Galvanised steel plate			
Dimensions (H × W × D)	mm	470 × 744 × 1,100	470 × 1,380 × 1,100		
Fan	Motor output	kW			
	Airflow rate	ℓ/s	300	466	583
		m <sup>3</sup> /min	18	28	35
External static pressure	220 V/240 V Pa	185/225	225/275	205/255	
Air filter		*2			
Refrigerant piping	Liquid	mm			
	Gas	φ 15.9 (Flare)	φ 19.1 (Brazing)	φ 22.2 (Brazing)	
	Drain	PS1B female thread			
Machine weight	kg	86	123		
Sound level *3	220 V/240 V dB(A)	42/43	47/48		
Connectable outdoor units *4		6 class and above	8 class and above	10 class and above	
Operation range (Fan mode operation between 15 and 19°C)	Cooling	19 to 43°C			
	Heating	-5 to 15°C			
Range of the discharge temperature *5	Cooling	13 to 25°C			
	Heating	18 to 30°C			

- Notes:
- \*1. Specifications are based on the following conditions:
    - Cooling: Outdoor temp. of 33°CDB, 28°CWB (68% RH), and discharge temp. of 18°CDB.
    - Heating: Outdoor temp. 0°CDB, -2.9°CWB (50% RH), and discharge temp. of 25°CDB.
    - Equivalent reference piping length: 7.5 m (0 m horizontal)
  - \*2. An intake filter is not supplied, so be sure to install the optional long-life filter or high-efficiency filter.
  - \*3. Anechoic chamber conversion value, measured at a point 1.5 m downward from the unit centre. These values are normally somewhat higher during actual operation as a result of ambient conditions.
  - \*4. It is possible to connect to the outdoor unit if the total capacity of the indoor units is 50% to 100% of the capacity index of the outdoor unit.
  - \*5. Local setting mode is not displayed on the remote controller.
    - This equipment cannot be incorporated into the remote group control of the VRF system.

### Options

	MODEL	FXMQ125MFV1	FXMQ200MFV1	FXMQ250MFV1
Operation/control	Operation remote controller	BRC1H63W(K) / BRC1E63 / BRC2E61		
	Central remote controller	DCS302CA61		
	Unified ON/OFF controller	DCS301BA61		
	Schedule timer	DST301BA61		
	Wiring adaptor for electrical appendices (2)	KRP4AA51		
Filters	Long-life replacement filter	KAF371N140	KAF371N280	
	High-efficiency filter	Colourimetric method 65%	KAF372M140	
			KAF373M140	
	Filter chamber *	Colourimetric method 90%	KAF373M140	
KDJ3705L140				
Drain pump kit		KDU30L250VE		
Adaptor for wiring		KRP1B61		

- Notes:
- \* Filter chamber has a suction-type flange. (Main unit does not.)
  - Dimensions and weight of the equipment may vary depending on the options used.
  - Some options may not be usable due to the equipment installation conditions, so please confirm prior to ordering.
  - Some options may not be used in combination.
  - Operating sound may increase somewhat depending on the options used.



# Air Treatment Equipment

## Outdoor-Air Processing Unit (Room Temperature Control Type)

### New FXMQ-AF Series

Improve IAQ with fresh air ventilation and precise room temperature control



Fresh air treatment and air conditioning can be achieved with a single system. **VRV** indoor units for air conditioning and an outdoor-air processing unit can be connected to the same refrigerant line.

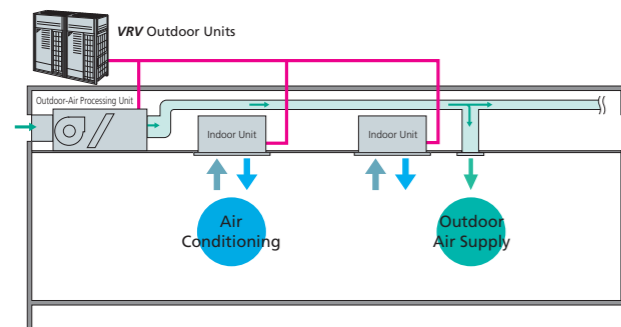

#### Lineup

Model Name	FXMQ80AFVM	FXMQ140AFVM	FXMQ200AFVM	FXMQ250AFVM
Capacity index	80	140	200	250
Airflow rate	690 m³/h	1,230 m³/h	1,740 m³/h	2,160 m³/h

Type of connected indoor units	Connction ratio	FXMQ-AF connection ratio
FXMQ-AF only	50%-130%	
Mixed combination (FXMQ-AF and standard VRV indoor units)	120%-130%	≤10%
	110%-120%	≤20%
	100%-110%	≤30%
	50%-100%	≤40%

$$\text{Connection ratio} = \frac{\text{Total capacity index of the indoor units}}{\text{Capacity index of the outdoor units}}$$

#### Larger connection ratio

Maximum connection ratio increased from 100% to 130%. When outdoor-air processing units and standard **VRV** indoor units are combined, the total connection capacity index of the outdoor-air processing units must not exceed 40% of the capacity index of the outdoor units.

### Outdoor-air processing / Room temperature control

The unit improves IAQ with fresh air ventilation and precise room temperature control.

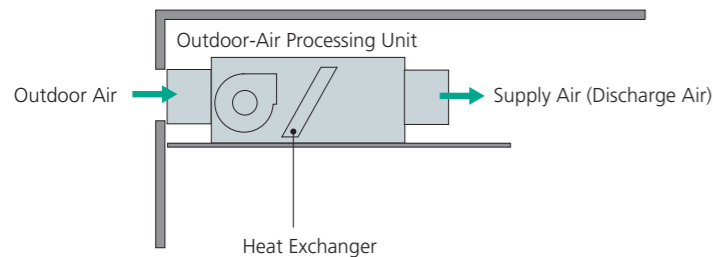

Set point temperature can be selected similar to standard **VRV** indoor unit. Maintains comfortability and precise temperature control in large areas with the remote sensor option BRC501A-6.

- \* This unit cannot be used to handle internal heat loads.
- \* The discharge air temperature changes depending on the air conditioning load, outside air temperature, and operation of the protective device.
- When the protection function is activated, unprocessed outside air maybe sent directly.
- \* The fan stops in defrosting, oil returning and hot start operations due to mechanical protection control.

#### 3-step airflow control

Control of the airflow rate has been improved from 1-step to 3-step control, which enhance usage and design flexibility.

#### Slim & compact design

Only 300 mm in height and 700 mm in depth, the new casing comes with smaller footprint and with 59% reduction\* in unit size.

\* Reduction in size compared to conventional FXMQ200/250MF series

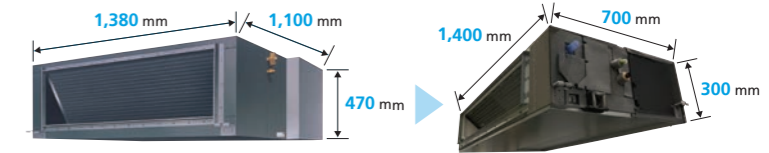

#### Lower power consumption

The change from AC motor to DC motor resulted in lower power consumption and more energy efficiency. The new FXMQ200AF requires 79% less power consumption making it the perfect choice for small commercial applications.

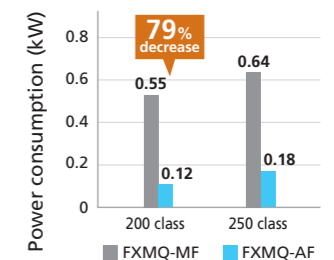

#### VRT control

With the VRT\* control feature, higher efficiency can be achieved.

\* Default setting is VRT off and field setting is required.



#### New small capacity model

The new 9 kW capacity model is the perfect fit for smaller business such as small/medium-sized shops and convenience stores.

#### Adjustable external static pressure

Using a DC fan motor, the external static pressure can be controlled within a range of 50 Pa to 200 Pa.

#### Adjustable external static pressure



#### "Airflow rate auto adjustment function" at field setting (local setting by remote controller)

\*This function can only be set via wired remote controller.

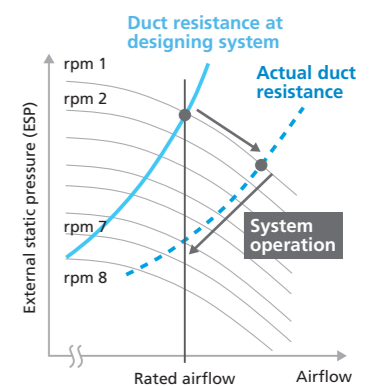
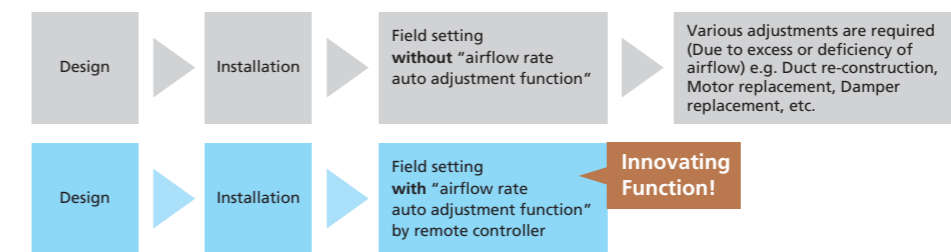

<Mechanism>

1. During field setting, power input of DC fan is detected.
2. External static pressure is estimated from power input of DC fan because PCB of FXMQ-AF has table of external static pressure vs. power input of DC fan.
3. Actual duct resistance is calculated according to 1 and 2.
4. Fan speed is automatically adjusted to produce rated airflow.

Notes: "Airflow rate auto adjustment function" can be adjusted within ±10% of rated airflow. (Refer to Engineering Data Book for details)  
"Airflow rate auto adjustment function" should be used at field setting only.

# Air Treatment Equipment

## Outdoor-Air Processing Unit (Room Temperature Control Type)

### Extended operation range

The outdoor operation temperature range extended from 19 to 15°CDB during cooling operation and from 15 to 19°CDB during heating operation\*. This enables reliable operation even under wider temperature conditions.

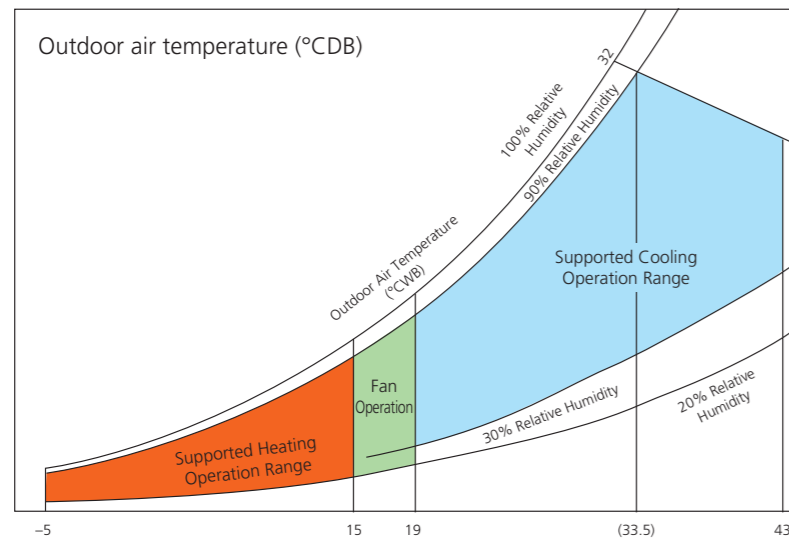

Extended operation range:  
**Cooling: 15°CDB to 43°CDB**  
**Heating: -5°CDB to 19°CDB**

\* Thermo-off (fan) operation starts automatically when cooling 19°CDB or less / heating 15°CDB or more. In case of cooling mode, operation range can be extended to 15°CDB by field setting. In case of heating mode, operation range can be extended to 19°CDB by field setting

### High efficiency filter (MERV8/MERV14) (Option)

The filter options of MERV8 and MERV14 are available. The high efficiency filter can help remove infectious aerosol in the air.



MERV8 filter



MERV14 filter

### Specifications

Model		FXMQ80AFVM	FXMQ140AFVM	FXMQ200AFVM	FXMQ250AFVM	
Power supply		1 phase, 220-230-240 V, 50/60 Hz				
Cooling capacity *1	Btu/h	30,700	54,600	76,400	95,500	
	kW	9.0	16.0	22.4	28.0	
Heating capacity *1	Btu/h	27,600	47,800	68,200	85,300	
	kW	8.1	14.0	20.0	25.0	
Power consumption	Cooling	0.080	0.100	0.115	0.180	
	Heating	0.095	0.125	0.155	0.225	
Casing		Galvanised steel plate				
Dimensions (HxWxD)		mm	300x700x700	300x1,000x700	300x1,400x700	
Fan	Motor output	kW	0.140	0.350		
	Airflow rate (H/M/L)	ℓ/s	192/143/97	342/257/172	483/363/242	600/450/300
		m <sup>3</sup> /min	11.5/8.6/5.8	20.5/15.4/10.3	29.0/21.8/14.5	36.0/27.0/18.0
External static pressure	Pa	Rated 100 (200-50)				
Air filter		*2				
Refrigerant piping	Liquid	mm	φ9.5 (Flare)			
	Gas		φ15.9 (Flare)	φ19.1 (Brazing)	φ22.2 (Brazing)	
	Drain		VP25 (External dia. 32, Internal dia. 25)			
Machine weight		kg	29	37	47	48
Sound level (H/M/L) *3		dB(A)	37.5/30/23	41/34/25	42/35/26	44/36/27
Operation range *4	Cooling	°CDB				
	Heating	15 to 43				
		-5 to 19				

Notes:

- \*1. The capacity is the maximum value under the following conditions:
  - Cooling: Indoor temp. of 33°CDB, 28°CWB, Outdoor temp. of 33°CDB.
  - Heating: Indoor temp. 0°CDB, -2.9°CWB, Outdoor temp. 0°CDB, -2.9°CWB.
  - Equivalent reference piping length: 7.5 m (0 m horizontal)
  - The rated external static pressure and air volume are set in 0.
- \*2. An intake filter is not supplied, so be sure to install the optional filter.
- \*3. Anechoic chamber conversion value, measured at a point 1.5 m downward from the unit centre. These values are normally somewhat higher during actual operation as a result of ambient conditions.
- \*4. The operation range can be extended to 15°C in cooling operation and 19°C in heating operation by field setting. When fresh air intake mode is enabled during cooling operation, operation range cannot be extended. (limit at 19 to 43°C)

### Options

Model		FXMQ80AFVM	FXMQ140AFVM	FXMQ200AFVM	FXMQ250AFVM
Operation/control	Wired remote controller	BRC1H63W(K) / BRC1E63 / BRC2E61			
	Wireless remote controller	BRC4C65			
	Remote sensor (for indoor temperature)	BRC501A-6			
	Central remote controller	DCS302CA61			
	Unified ON/OFF controller	DCS301BA61			
	Schedule timer	DST301BA61			
Filters	MERV8 filter	BAF376B56	BAF376B80	BAF376B160	
	MERV14 filter	BAF377B56	BAF377B80	BAF377B160	
	Filter chamber for MERV8/14 filter	KDDF37AB56	KDDF37AB80	KDDF37AB160	
	Long life replacement filter	KAF371B56	KAF371B80	KAF371B160	
Service panel		KTBJ25K56F	KTBJ25K80F	KTBJ25K160F	
Air discharge adaptor		KDAJ25K56A	KDAJ25K71A	KDAJ25K140A	
Adaptor for wiring (operation status output)		★ BRP11B62			
Wiring adaptor for electrical appendices (1)		★ KRP2A61			
Wiring adaptor for electrical appendices (2)		★ KRP4AA51			
Installation box for adaptor PCB ☆ *1		★ KRP4A96 *2,3			
External control adaptor for outdoor unit		★ DTA104A61			
Adaptor for multi tenant (24V type)		★ DTA114A61			
Multi tenant unit for indoor (24V free type)		★ BRP114A61			
Multi tenant unit Booster (24V free type)		★ BRP114A63			
Digital input adaptor for hotel application		★ BRP7A53			

Notes:

- \*1. Installation Box ☆ is necessary for each adaptor marked ★.
- \*2. Up to 2 adaptors can be fixed for each installation box.
- \*3. Only one installation box can be installed for each indoor unit.

# Air Treatment Equipment

## Heat Reclaim Ventilator

### VAM-H Series

Daikin VAM series ensures fresh air intake and energy savings



Lineup		
VAM150HVE	VAM250HVE	VAM350HVE
VAM500HVE	VAM650HVE	VAM800HVE
VAM1000HVE	VAM1500HVE	VAM2000HVE

Airflow rate: 150-2,000 m<sup>3</sup>/h



BRC1H63W BRC1H63K

### New features

#### Design flexibility

By significantly improving external static pressure, support for a variety of duct layouts is possible, and installation flexibility has been improved.

The 1000-2000 class model has become more compact, and ease of installation has improved.

#### Comparison of external static pressure

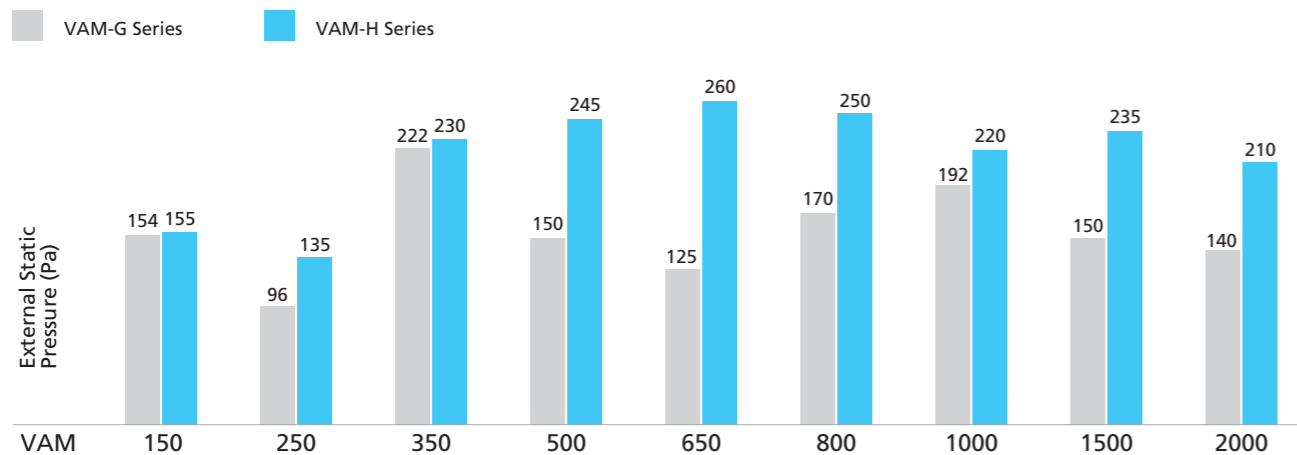

#### Improvement of installation workability

##### Improved workability by changing dimensions and shape of lifting lug

The structure that prevents nut slippage eliminates the need to replace the lifting lug even when installed upside down.

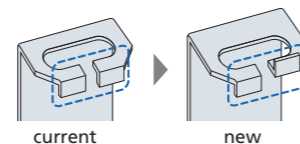

### Energy saving

#### Sensing sensor stop mode

In situation of no human occupancy is detected, the operation is turned off.

When the "Sensing sensor" installed on the air conditioner detects no occupancy in the room, the ventilation system and air conditioner system is turned off automatically to reduce energy wastage.

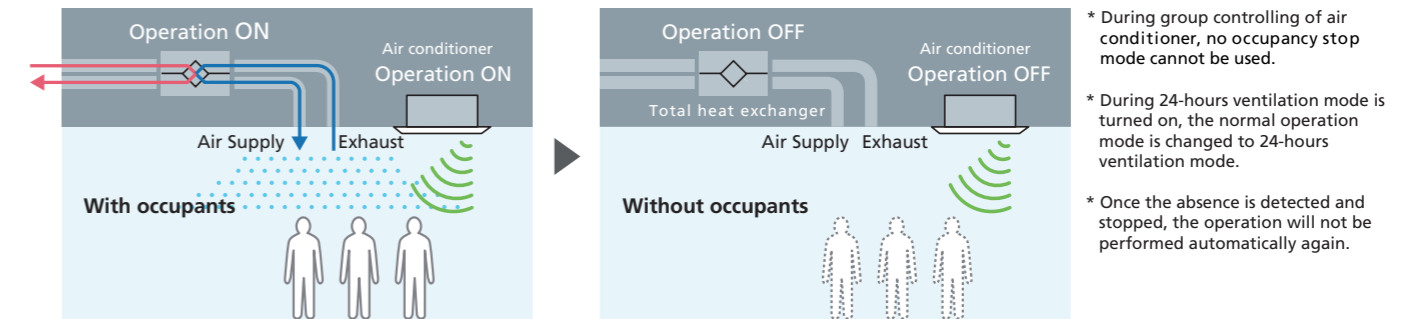

#### Humidity sensor (Option)

A humidity sensor (option) can be installed for greater comfort and energy-saving ventilation.

Conditions of low temperature and high humidity... Example, a rainy day, etc.

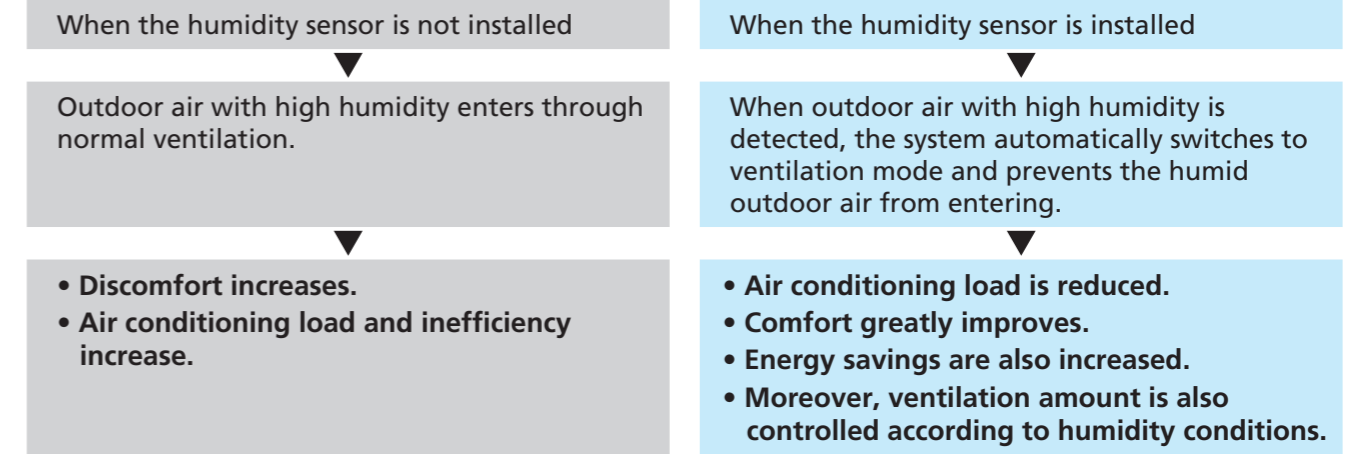

#### Stylish remote controller

##### NEW Stylish Remote Controller BRC1H63W (K) combining many VAM-dedicated functions

- Sensor results can be displayed up to 3 item on the information screen.
- Sensor results can be shared to the remote controller group.
- New icons such as 24-Hour Ventilating, Fresh Up, Nighttime Free Cooling Operation (Night Purge) have been added to the Information screen.

NEW Sensor view of the Information screen

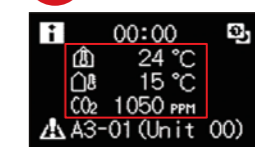

Note: 3 items selected by remote controller setting.



# Air Treatment Equipment

## Heat Reclaim Ventilator

### Energy saving / Heat recovery functions

Air conditioner and ventilation system can be interlocked to provide even greater comfort and energy saving.

The system can be interlocked with Daikin air conditioners to provide energy saving ventilation solution for various situation.



### Pre-cool, Pre-heat control

#### Intentional delay of the start-up time

When the air conditioner is started up, the ventilation start-up is delayed to reduce load caused by the outside air. This reduces power consumption of air conditioners.

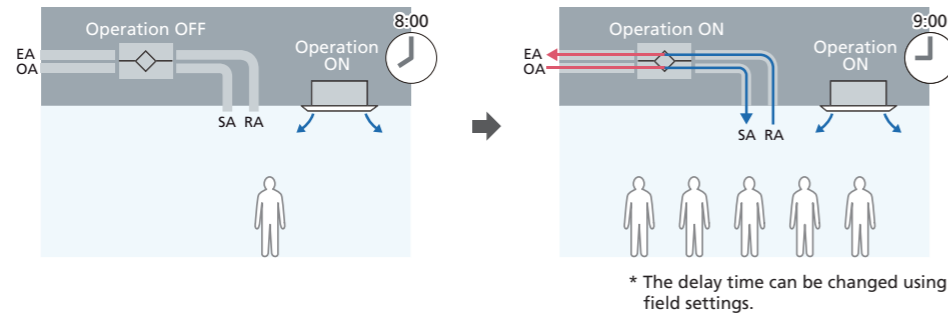

### Auto-ventilation mode changeover switching

#### Automatically determine the appropriate ventilation for each situation

Indoor temperature and the outdoor temperature are detected, and the system automatically switches to the ventilation mode which has higher energy-saving effect.

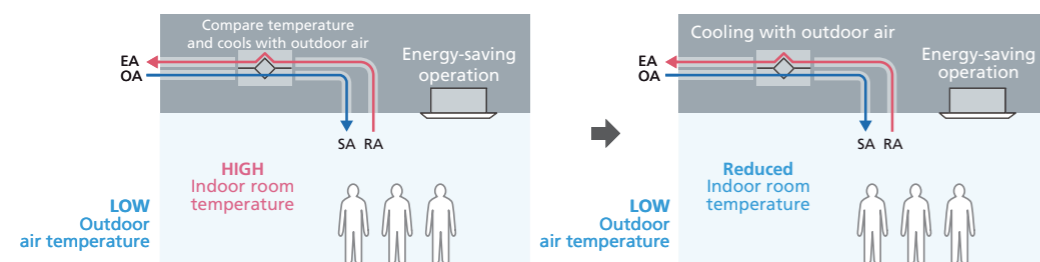

### Nighttime free cooling operation

#### Efficient use of outdoor air at night.

Rise in indoor temperature is avoided by automatically cooling the outdoor air at night, thus reducing air conditioning load at the start of cooling operation on the next morning.

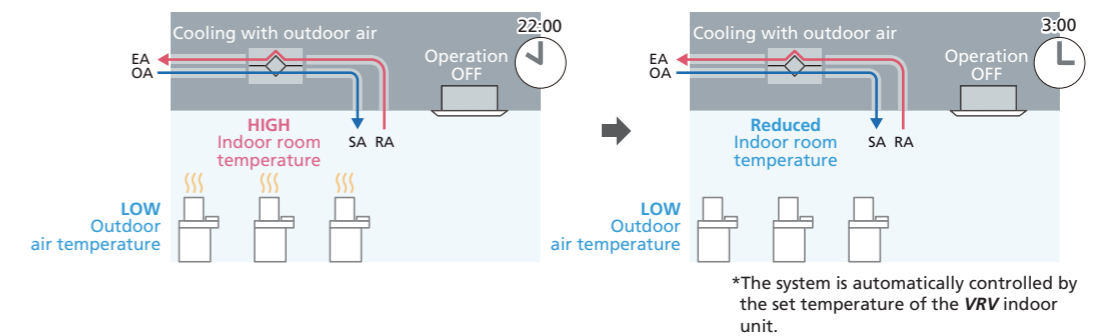

### CO<sub>2</sub> sensor control (Option) \*Refer to pages 179 for details.

When CO<sub>2</sub> sensor is installed, it detects the concentration of CO<sub>2</sub> in the indoor air and the Ventilation rate is controlled appropriately, reducing the air conditioning load due to ventilation.

### Improvement of IEQ (Indoor Environmental Quality)

#### PM2.5 filter (Option) \*Refer to pages 180 - 182 for details.

Removes PM2.5 particulate matter present in the outdoor air, as well as sulfur oxides and nitrogen oxides, providing clean fresh air to the indoor ambient.

- PM2.5 filter: Removes 99% or more of 2.5 μm particulate matter.
- Activated Carbon filter: Removes sulfur oxides and nitrogen oxides.

### Fresh Air Comfort

Round Flow Cassette indoor units can be connected to a duct to provide fresh outdoor air for comfortable air from the air conditioner. Installation is also possible for existing indoor units.

- 1 Heat Reclaim Ventilator
- + 2 Round Flow Cassette (including with sensing type)

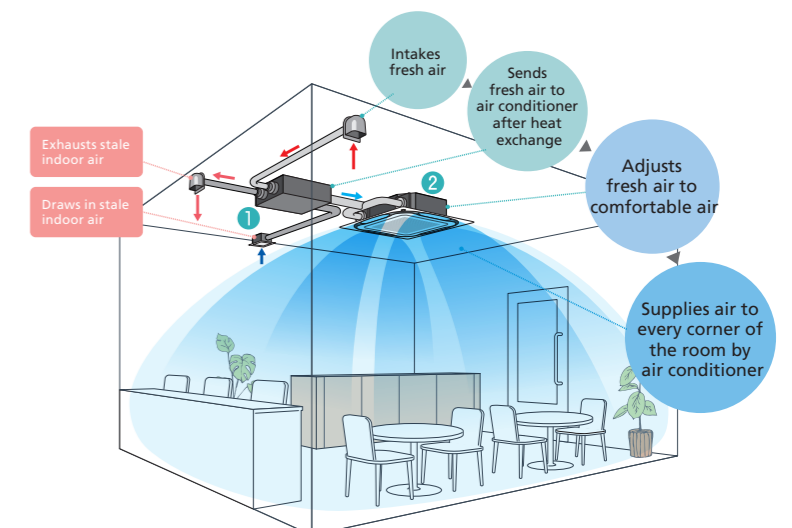

# Air Treatment Equipment



## Heat Reclaim Ventilator

### Specifications

Model			VAM150HVE	VAM250HVE	VAM350HVE	VAM500HVE	VAM650HVE	VAM800HVE	VAM1000HVE	VAM1500HVE	VAM2000HVE												
Power Supply			Single phase, 220-240 V/220 V, 50/60 Hz																				
Temperature exchange efficiency (50/60 Hz)	For Cooling	Ultra-High	66.0/66.0	60.5/60.5	65.0/65.0	61.5/61.5	59.5/59.5	61.5/61.5	58.0/58.0	61.5/61.5	58.5/58.5												
		High	66.0/66.0	60.5/60.5	65.0/65.0	61.5/61.5	59.5/59.5	61.5/61.5	58.0/58.0	61.5/61.5	58.5/58.5												
		Low	69.0/69.5	65.0/65.5	70.0/70.0	63.0/64.0	62.5/63.0	64.0/65.0	61.5/62.0	65.5/66.0	65.5/65.5												
	For Heating	Ultra-High	77.0/77.0	76.5/76.5	79.5/79.5	80.0/80.0	74.5/74.5	77.5/77.5	74.0/74.0	77.5/77.5	73.5/73.5												
		High	77.0/77.0	76.5/76.5	79.5/79.5	80.0/80.0	74.5/74.5	77.5/77.5	74.0/74.0	77.5/77.5	73.5/73.5												
		Low	78.5/79.0	78.5/79.0	81.5/82.0	81.5/82.5	76.5/77.0	78.5/79.0	76.0/76.5	79.5/80.0	76.5/77.0												
Enthalpy exchange efficiency (50/60 Hz)	For Cooling	Ultra-High	63.5/63.5	60.0/60.0	62.5/62.5	62.5/62.5	60.0/60.0	63.0/63.0	60.0/60.0	63.0/63.0	60.0/60.0												
		High	63.5/63.5	60.0/60.0	62.5/62.5	62.5/62.5	60.0/60.0	63.0/63.0	60.0/60.0	63.0/63.0	60.0/60.0												
		Low	66.0/66.5	61.5/62.0	64.5/65.0	64.0/65.0	62.5/63.0	64.5/65.5	62.0/62.5	65.5/66.0	64.5/64.5												
	For Heating	Ultra-High	71.5/71.5	69.5/69.5	72.0/72.0	71.0/71.0	68.0/68.0	72.0/72.0	68.5/68.5	72.0/72.0	68.0/68.0												
		High	71.5/71.5	69.5/69.5	72.0/72.0	71.0/71.0	68.0/68.0	72.0/72.0	68.5/68.5	72.0/72.0	68.0/68.0												
		Low	76.5/77.0	73.0/73.5	74.5/75.0	72.5/73.5	69.5/71.5	74.0/75.0	72.0/72.5	74.0/75.0	71.0/71.5												
Power Consumption (50/60 Hz)	Heat exchange mode	Ultra-High	96-103/132	126-141/172	178-193/231	296-326/390	381-426/472	664-684/829	683-736/883	1,274-1,353/1,645	1,365-1,471/1,763												
		High	90-93/118	114-123/144	163-170/207	248-261/329	307-319/413	603-612/712	621-656/763	1,207-1,225/1,423	1,241-1,311/1,526												
		Low	68-73/67	75-83/79	132-142/145	223-233/268	264-276/332	504-544/562	539-569/594	1,008-1,089/1,125	1,079-1,138/1,188												
	Bypass mode	Ultra-High	96-103/132	126-141/172	178-193/231	296-326/390	381-426/472	664-684/829	683-736/883	1,274-1,353/1,645	1,365-1,471/1,763												
		High	90-93/118	114-123/144	163-170/207	248-261/329	307-319/413	603-612/712	621-656/763	1,207-1,225/1,423	1,241-1,311/1,526												
		Low	68-73/67	75-83/79	132-142/145	223-233/268	264-276/332	504-544/562	539-569/594	1,008-1,089/1,125	1,079-1,138/1,188												
Sound Level (50/60 Hz)	Heat exchange mode	Ultra-High	33.0-34.0/34.0	33.0-34.0/33.5	32.0-33.0/34.5	36.0-37.0/38.5	37.5-38.0/38.0	41.5-42.5/41.0	42.0-43.0/42.5	43.0-44.0/44.0	43.5-44.0/44.5												
		High	30.5-32.0/28.0	31.5-32.5/28.0	30.0-31.5/27.5	35.0-36.0/35.0	36.0-36.5/37.0	39.5-41.0/37.0	40.0-41.0/38.0	41.0-42.5/39.0	41.5-43.0/40.0												
		Low	23.0-25.5/20.0	23.0-25.5/21.0	26.5-28.5/22.0	32.0-34.0/31.0	34.0-35.0/32.5	36.0-38.5/33.0	38.0-39.5/34.5	38.0-40.5/35.0	39.0-41.0/36.5												
	Bypass mode	Ultra-High	33.5-34.0/36.0	33.0-34.0/34.5	32.5-33.5/34.5	36.0-37.0/38.5	39.5-40.0/42.0	41.5-42.5/41.0	42.0-43.0/42.5	43.0-44.0/44.0	43.5-44.0/44.5												
		High	31.5-33.0/28.5	31.0-32.5/29.0	31.0-32.0/27.5	35.0-36.0/35.0	38.0-38.5/39.0	39.5-41.0/37.0	40.0-41.0/38.0	41.0-42.5/39.0	41.5-43.0/40.0												
		Low	23.0-25.5/20.5	23.5-25.5/21.5	27.0-29.0/23.0	32.0-34.0/31.0	35.5-36.5/33.5	36.0-38.5/33.0	38.0-39.5/34.5	38.0-40.5/35.0	39.0-41.0/36.5												
Casing			Galvanised steel plate																				
Insulation Material			Self-extinguishable polyurethane foam																				
Dimensions (H x W x D)			mm			278 x 551 x 810			306 x 800 x 879			338 x 832 x 973			387 x 1,012 x 1,110			785 x 1,012 x 1,110					
Machine Weight			kg			22			31			41			43			63			133		
Heat Exchange System			Specially processed nonflammable paper																				
Heat Exchange Element Material			Multidirectional fibrous fleeces																				
Fan	Type	Sirocco fan																					
		Airflow Rate (50/60 Hz)	Ultra-High	150/150	250/250	350/350	500/500	650/650	800/800	1,000/1,000	1,500/1,500	2,000/2,000											
			High	150/150	250/250	350/350	500/500	650/650	800/800	1,000/1,000	1,500/1,500	2,000/2,000											
	Low		100/80	165/145	275/235	470/420	570/495	720/610	880/835	1,350/1,250	1,650/1,580												
	External static pressure (50/60 Hz)	Ultra-High	125-140/155	115-130/135	170-185/230	165-190/245	185-190/260	210-235/250	205-225/220	195-215/235	190-210/210												
		High	100-120/100	80-90/60	145-165/80	140-175/180	140-155/210	170-215/140	155-195/100	150-180/125	140-180/85												
Low		44-80/28	35-75/20	90-102/36	124-155/127	108-119/122	138-174/81	115-150/70	123-146/88	96-123/53													
Motor Output	kW	0.030 x 2		0.060 x 2		0.100 x 2		0.170 x 2		0.190 x 4													
Effective ventilation rate	Ultra-High	90																					
Connection duct diameter	Indoor side	mm		φ100		φ150		φ200		φ250		φ250 x 4											
	Outdoor side	mm		□(680 x 290) x 2																			
Unit ambient condition			-15°C to 50°CDB, 80%RH or less																				

- Notes:
- Airflow rate can be changed over to Low mode or High mode.
  - Temperature Exchange Efficiency is the mean value between cooling and heating.
  - Efficiency is measured under the following conditions: Ratio of rated external static pressure has been maintained as follows; outdoor side to indoor side = 7 to 1.
  - In conformance with JIS standards (JIS B 8628), operating sound level is based on the value when one unit is operated, with the value converted for an anechoic chamber. This is transmission sound from the main unit, and does not include sound from the discharge grille. Thus it is normal for the sound to be louder than the indicated value when the unit is actually installed.

### Remote controller function for Heat Reclaim Ventilator

Function	Detail	BRC1H63W(K)	BRC1E63	BRC2E61
				
Air conditioner interlock	Interlock Heat Reclaim Ventilator with air conditioner by one remote controller	●	●	●
Ventilation mode	Switch the ventilation mode (Automatic, Heat exchange, Bypass)	●	●	—
Ventilation airflow rate	When using CO <sub>2</sub> sensor, ventilation volume can be changed	●	●	●
Fresh up indication	Indicates that fresh up operation is being carried out	●	—	—
CO <sub>2</sub> indication	Indicates value of CO <sub>2</sub> sensor	○	—	—
Outdoor temperature indication	Indicates outdoor air temperature (OA)	○	—	—
Nighttime free cooling indication	Indicates that night purge operation is set	○	—	—
24 hour ventilating indication	Indicates that 24 hour ventilating operation is set	○	—	—
Ventilating operation indication	Indicates that ventilating operation is being carried out even when night purge operation and 24 hour ventilating operation is being carried out	●	●	—
Ventilating standby indication	Indicates that ventilating operation has been stopped temporarily during pre-cool / pre-heat control	○	—	—
Sharing CO <sub>2</sub> data	Share the CO <sub>2</sub> data to submit from main unit with in the group	○	—	—

○ : New functions / ● : Installed functions

### Options

Item	MODEL	VAM150HVE	VAM250HVE	VAM350HVE	VAM500HVE	VAM650HVE	VAM800HVE	VAM1000HVE	VAM1500HVE	VAM2000HVE		
Additional function	Silencer	—										
	Nominal pipe   mm	—			φ200			KDDM24B100			KDDM24B100 x 2	
High efficiency filter	Air filter for replacement	KAF242J25M		KAF242J50M		KAF242J65M		KAF242K100M		KAF242K100M x 2		
		KAF241L25M		KAF241L35M		KAF241L65M		KAF241L100M		KAF241L100M x 2		
Flexible duct (1m)		K-FDS101E		K-FDS151E		K-FDS201E		K-FDS251E				
Flexible duct (2m)		K-FDS102E		K-FDS152E		K-FDS202E		K-FDS252E				
CO <sub>2</sub> sensor*2		BRYC24A25M		BRYC24A35M		BRYC24A65M		BRYC24A100M				
Humidity sensor		BRYH241A100 (for RA) / BRYH242A100 (for OA)										
PM2.5 filtration unit*3		BAF249A150	BAF249A300	BAF249A350	BAF249A500	—		BAF429A20A				
PM2.5 with activated carbon filtration unit*3		BAF249A150C	BAF249A300C	BAF249A350C	BAF249A500C	—		BAF429A20AC				
Wired remote controller		BRC1H63W (White) / BRC1H63K (Black) / BRC1E63 / BRC2E61										
Controlling device	Centralised remote controller	DCS303A51*1										
	Central remote controller	DCS302CA61										
	Unified ON/OFF controller	DCS301BA61										
	Schedule timer	DST301BA61										
	Wiring adaptor for electrical appendices	KRP2A62										
PCB Adaptor	Installation box for adaptor PCB	KRP1C18A90										
	For heater control kit	BRP4A50A										
	PCB adaptor for wiring	KRP1C18										

- Notes: \*1. For residential use only. When connect with a Heat Reclaim Ventilator (VAM), you can only switch the power ON/OFF. It cannot be used with other central control equipment. \*2. Refer to pages 179 for details. \*3. Refer to pages 180 - 182 for details.

### PCB adaptor for heater control kit [BRP4A50A] (Option)

When the installation of an electric heater is required in a cold region, this adaptor with an internal timer function eliminates the complicated timer connecting work that was necessary with conventional heaters.

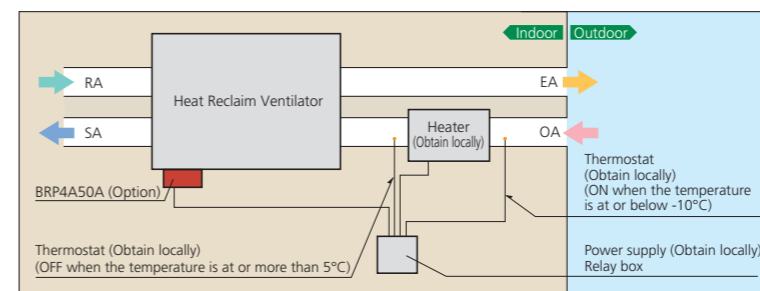

- Notes when installing:
- Examine fully an installation place and specification for using the electric heater based on the standard and regulation of each country.
  - Supply the electric heater and safety production devices such as a relay and a thermostat, etc of which qualities satisfy the standard and regulation of each country at site.
  - Use a non-inflammable connecting duct to the electric heater. Be sure to use 2 m or more between the electric heater and the Heat Reclaim Ventilator for safety.
  - For the Heat Reclaim Ventilator, use a different power supply from that of the electric heater and install a circuit breaker for each.

# Air Treatment Equipment

## Airflow rate control with CO<sub>2</sub> sensor (Option) for VAM series

The CO<sub>2</sub> sensor controls airflow rate so that it best matches the changes of CO<sub>2</sub> level in the room. This prevents energy losses from over-ventilation while maintaining indoor air quality with optional CO<sub>2</sub> sensor.

● Example of CO<sub>2</sub> sensor operation in an office room:

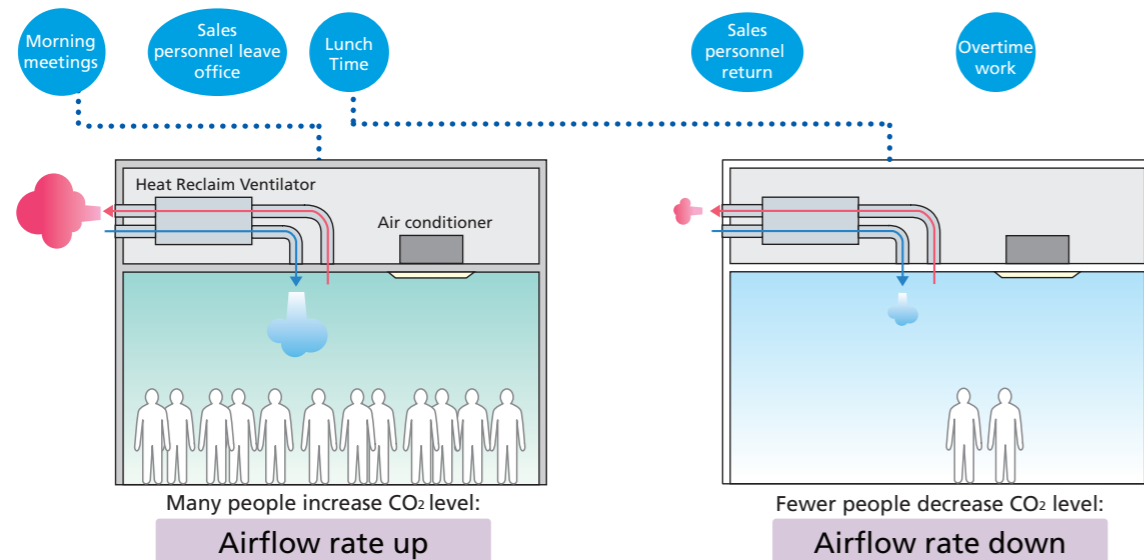
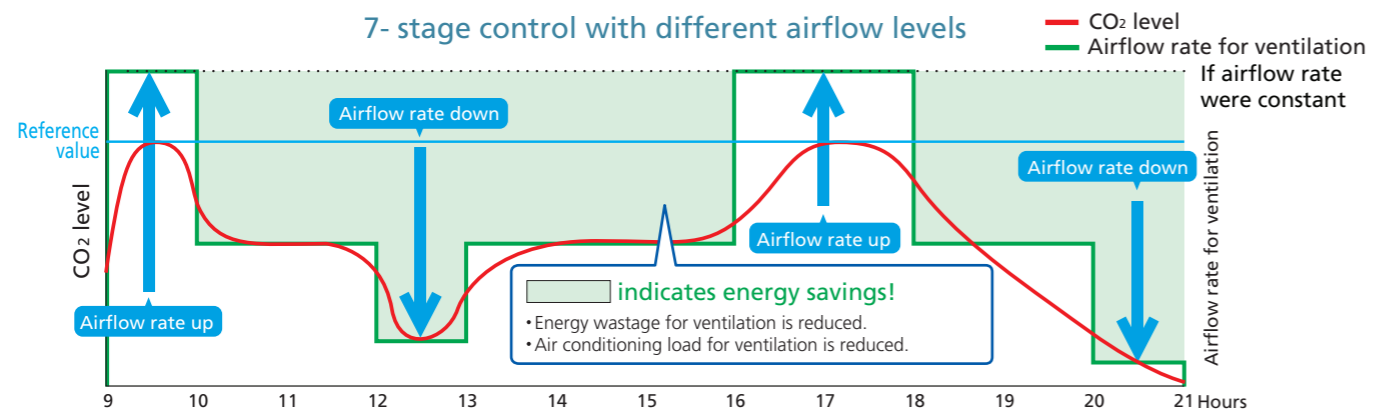

## PM2.5 filtration unit (Option) for VAM series

Rapid urbanization has increased industrial and automobile emissions, resulting in higher PM2.5 levels. This has become the source of respiratory diseases and poses a serious threat to a long term health issue. As the air quality has worsened, research has shown the harmful effects of PM2.5 on the health of the general public.

### Double-layered efficient filtration

PM2.5 filters are double-layered.

1. The front filter effectively removes large particles.
2. The PM2.5 filter layer contains a large amount of static electricity to capture particulate matter efficiently.



### Filtering PM2.5 efficiently for healthier and more comfortable environments

This filter removes 99% or more of 2.5 μm particulate matter.

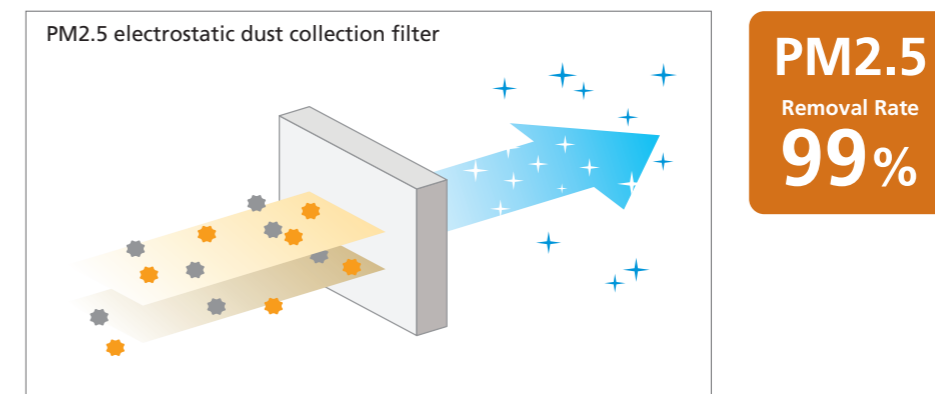

\*Test results by the Heating, Ventilation and Air Conditioning Lab at Tongji University  
Test environment: temperature 25-26°CDB, humidity 58-60%RH



# Air Treatment Equipment

## Electrostatic dust collection filter: more efficient and longer lasting effect

The PM2.5 filter layer contains a large amount of static electricity to capture particulate matter efficiently, including those smaller than the grid mesh. The filter is difficult to be blocked by particles and has good ventilation and long life span.

**Daikin Electrostatic Dust Collecting Filtration**

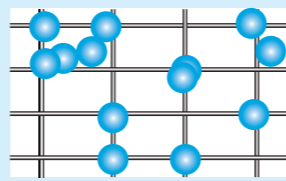

With the capturing effect of static electricity, particles are adsorbed on the filter fabric.



The filter is not blocked and therefore continuous Supply Air is guaranteed.

Long-lasting highly efficient dust collection capacity

## PM2.5 with activated carbon filtration unit (Option) for VAM series

Extra-high performance filter against sulfur oxides and nitrogen oxides

### Effective Use of Active Carbon Material to Enlarge the Adsorption Area

As an expert in the research and development of filters, DAIKIN has specifically selected active carbon material as the main substance to constitute the filter against sulfur oxides and nitrogen oxides. The material's usable pore surface is fully exploited, thus extending the filter's durability.

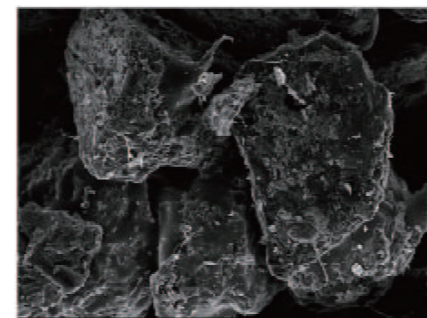

Notes: Surface area of active carbon: 700 m<sup>2</sup>/g  
Given a newspaper page of 40.6 cm wide by 54.6 cm long, each gram of active carbon has a surface area of 3,000 newspaper pages.

### Intelligent Identification, Super-effective Adhesion

The special substance added in the pores of active carbon can exclusively target sulfur oxide and nitrogen oxide gases and stick to them without blocking other unidentified gases. This ensures long durability of the filter.

Note: The figures are based on in-house tests under the following lab conditions: temperature 22 to 25°CDB, humidity 35 to 40% RH, air flow rate 0.2 m/s.

Unidentified Gases

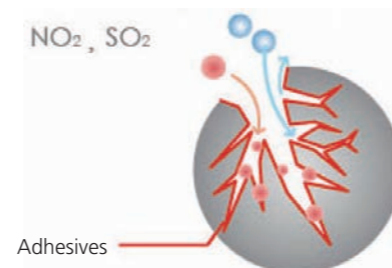

## Specifications

### PM2.5 filtration unit

MODEL		BAF249A150	BAF249A300	BAF249A350	BAF249A500	BAF429A20A
Dimensions (H x W x D)	mm	220x603x366	220x603x366	300x623x366	300x623x366	470x971x370
Connection Duct Diameter	mm	φ 100	φ 150	φ 150	φ 200	580x348
Airflow Rate	m <sup>3</sup> /h	150	250	350	500	2,100
PM2.5 Filter	Initial Pressure Drop	Pa	34	30	31	42
	Filter Lifetime <sup>*1</sup>		1 year			
	Filtration Efficiency <sup>*2</sup>		99% or higher			
	Filter Material No. <sup>*3</sup>		BAF244A300		BAF244A500	BAF424A20A

Notes: 1. Annual usage: 400 hrs/month x 12 months = 4,800 hrs  
2. 99% or higher removal rate of ultra-fine particles with diameters of 2.5 μm or more.  
3. Filters come with applicable filtration units with a one-year life. They can be purchased and replaced according to their model numbers.

### PM2.5 with activated carbon filtration unit

MODEL		BAF249A150C	BAF249A300C	BAF249A350C	BAF249A500C	BAF429A20AC
Dimensions (H x W x D)	mm	220x603x366	220x603x366	300x623x366	300x623x366	470x971x370
Connection Duct Diameter	mm	φ 100	φ 150	φ 150	φ 200	580x348
Airflow Rate	m <sup>3</sup> /h	150	250	350	500	2,100
Total Initial Pressure Drop for PM2.5 with Activated Carbon Filtration Unit	Pa	37	35	36	51	less than 50
PM2.5 Filter	Initial Pressure Drop	Pa	34	30	31	42
	Filter Lifetime <sup>*1</sup>		1 year			
	Filtration Efficiency <sup>*2</sup>		99% or higher			
	Filter Material No. <sup>*3</sup>		BAF244A300		BAF244A500	BAF424A20A
Activated Carbon Filter	Initial Pressure Drop	Pa	3	5	9	less than 10
	Filter Lifetime		1 year			
	Filter Material No. <sup>3</sup>		BAF244A300C		BAF244A500C	BAF424A20AC

Notes: 1. Annual usage: 400 hrs / month x 12 months = 4,800 hrs.  
2. 99% or higher removal rate of ultra-fine particles with diameters of 2.5 μm or more.  
3. Filters come with applicable filtration units with a one-year life. They can be purchased and replaced according to their model numbers.

# Control Systems

## Individual control systems for VRV systems

### Stylish remote controller (Option) New



Special Site



White  
BRC1H63W



Black  
BRC1H63K

A complete redesigned controller focused to enhance user experience



reddot design award

### Sleek and stylish design

- Combines refinement and simplicity
- Echoes the distinct blue circle and simplicity of design
- Two attractive colours to match any interior
- Compact, measures only 85 x 85 mm



### User-friendly interface

- Just three buttons and a large-figure display
- Customisable display
- Direct access to basic functions (ON/OFF, Operation mode, Temperature setting, Airflow rate, Airflow direction)
- Timer functions (OFF timer, Weekly schedule timer)
- Simple screen for hotel display



### Easy setting via smartphone application using Bluetooth® wireless technology (for Installer/Facility manager)

## Keep hotel room comfortable

- Improved setback function by setting the lower temperature limit in cooling and higher temperature in heating mode.
- Window/door contact interlock function is available via optional Digital Input Adaptor BRP7A\*.



<App screen image>

## Shorter installation time

- Easy to create multiple remote control and field settings via App
- Prepare a setting in advance at the office and immediately send it to the on-site remote controller
- Save and reuse settings
- Remote update function (OTA: Over The Air)

### "Nav Ease" (Wired remote controller) (Option)



BRC1E63



BRC1F61  
(Only for FXEQ series)

A series of user friendly functions that can be individually selected

### Energy saving

#### Setpoint range set

- Avoids excessive cooling or heating by limiting the min. and max. set temperature.
- Convenient for use at a place where any number of people may operate it.

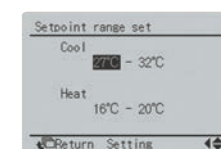

#### Setpoint auto reset

- Even if the set temperature is changed, the new set temperature returns to the previous preset value after a preset duration of time.
- Period selectable from 30, 60, 90, or 120 min.

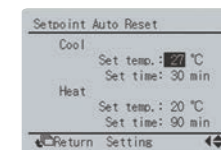

#### Off timer

- Period can be preset from 30 to 180 minutes in 10-minute increments.

### Convenience

#### Setback (default: OFF)

- Maintains the room temperature in a specific range during unoccupied period by temporarily starting air conditioner that was turned OFF.

#### Weekly schedule

- 5 actions per day can be scheduled for each day of the week.
- The holiday function will disable schedule timer for the days that have been set as holiday.
- 3 independent schedules can be set. (e.g. summer, winter, mid-season)

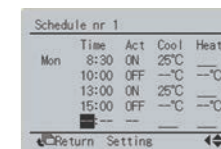

#### Auto display off

- Period can be preset from 10, 30, 60 minutes, and OFF. Initial setting is 30 minutes.

### Comfort

#### Individual airflow direction

- Airflow direction can be individually adjusted for each air discharge outlet.

#### 5-step airflow control

- Airflow rate can be selected from 5-step control.

#### Auto airflow rate

- Airflow rate is automatically controlled.

# Control Systems

## Individual control systems for VRV systems

### Simplified remote controller (Option)



BRC2E61

### Easy operation with new intuitive design

#### Simple operation

Using only six buttons, users have direct access to basic functions. This enables them to easily set comfort to their preference.

- ON/OFF
- Operation mode
- Temperature setting
- Airflow rate (5-step & Auto)\*
- Up and down airflow direction (5-step & Swing)\*
- ON/OFF timer

\* The number of airflow steps and availability of auto airflow rate and swing mode depend on the type of indoor unit.

#### Intuitive design

- By using pictograms, the user-friendly interface enables convenient and easy operation.

#### Compact size

- Measuring only 85 x 85 mm, the new remote controller is extremely compact and complements any interior design.



### Wireless remote controller (Option)



BRC-M series



Signal receiver unit (Installed type)

- The wireless remote controller is supplied in a set with a signal receiver.
- Signal receiver unit of installed type is contained inside decoration panel or indoor unit.
- Shape of signal receiver unit differs according to the indoor unit.

Note: The signal receiver unit shown in the photograph is for mounting inside the decoration panel of FXF(S)Q series.

- Backlight LCD of new wireless remote controller



Pressing the backlight button helps operating in dark rooms.

- A compact signal receiver unit (separate type) to be mounted into a wall or ceiling is included.

\* Wireless remote controller and signal receiver unit are sold as a set.  
\* Refer to page 214 for the name of each model.

### Wide variation of remote controllers for VRV indoor units

MODEL	FXFTQ	FXFSQ	FXFQ	FXZQ	FXCQ	FXEQ	FXDQ	FXDYQ	FXSQ	FXMQ	FXUQ	FXHQ	FXAQ	FXL(N)Q
Stylish remote controller (BRC1H62W / BRC1H62K)	●	●	●	●	●	●	●	●	●	●	●	●	●	●
*"Nav Ease" remote controller (BRC1E63)		●	●	●	●		●	●	●	●	●	●	●	●
*"Nav Ease" remote controller (BRC1F61)						●								
Simplified remote controller (BRC2E61)			●	●	●	●	●	●	●	●	●	●	●	●
Wireless remote controller* (Installed type signal receiver unit)		●	●	●	●	●					●	●	●	
Wireless remote controller* (Separate type signal receiver unit)							●	●	●	●				●

\*Refer to page 214 for the name of each model.

### The wired remote controller supports a wide range of control functions

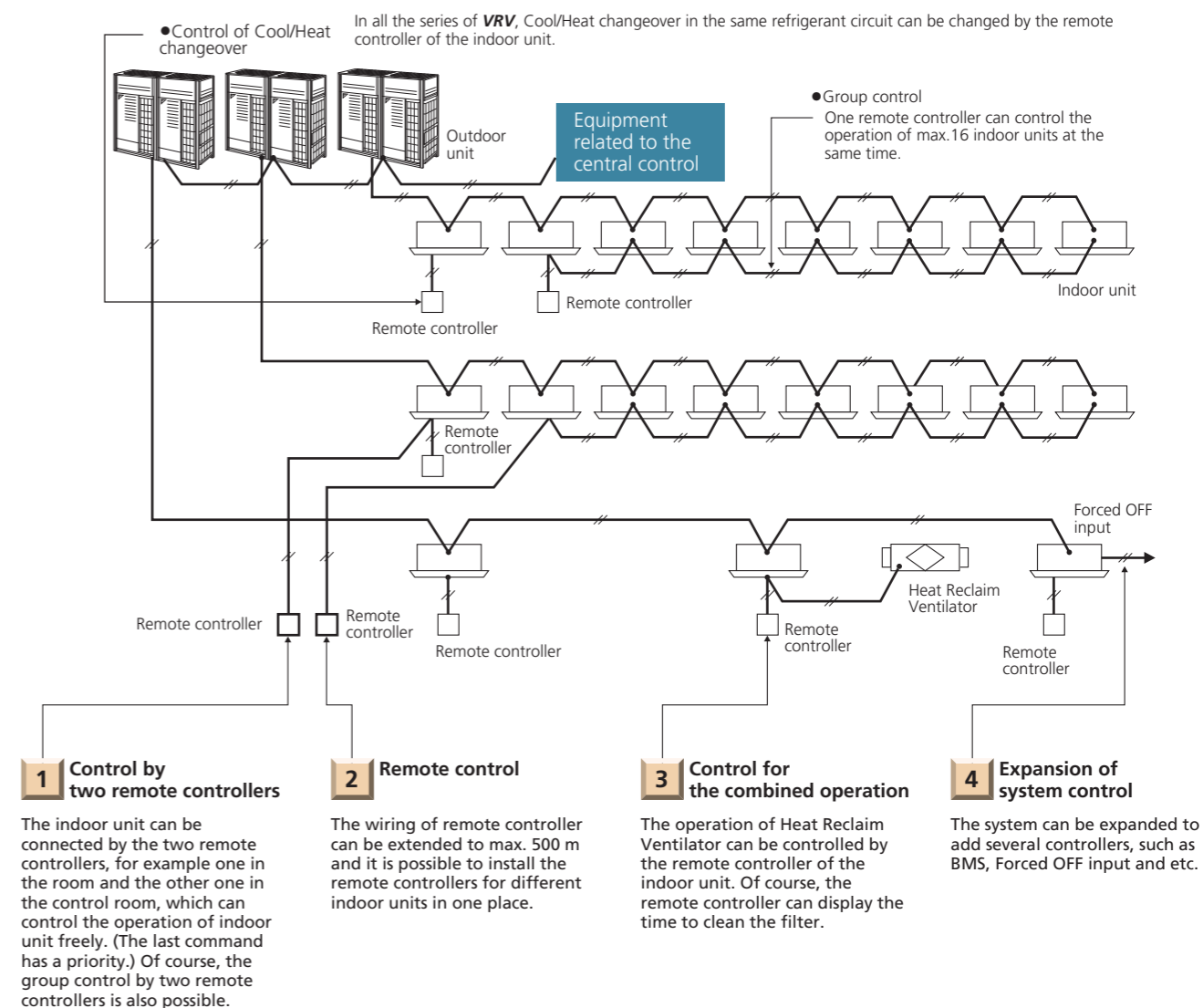



# Control Systems

## Integrated building monitoring system

The high speed transmission of DIII-NET enables more advanced control of the VRV system, providing you with enhanced comfort.

- DIII-NET Line
- BACnet®/Ethernet or LONWORKS® Network Communication Line
- - - Contact Signal Line
- RS485 Modbus® Line

**The DIII-NET system provides for:**

- Close control and monitoring by integrating a wide variety of air-conditioners in the entire building.
- Saves the in-building cabling using non-polar, two-wire cables. Easier wiring work with tremendously fewer wiring errors.
- Additional setups readily up and running. An extendable cabling up to 2 km in total.
- Different control equipment flexibly joined in the system for hierarchical risk diversification.
- Daikin's total heat exchangers and other devices under integral control.

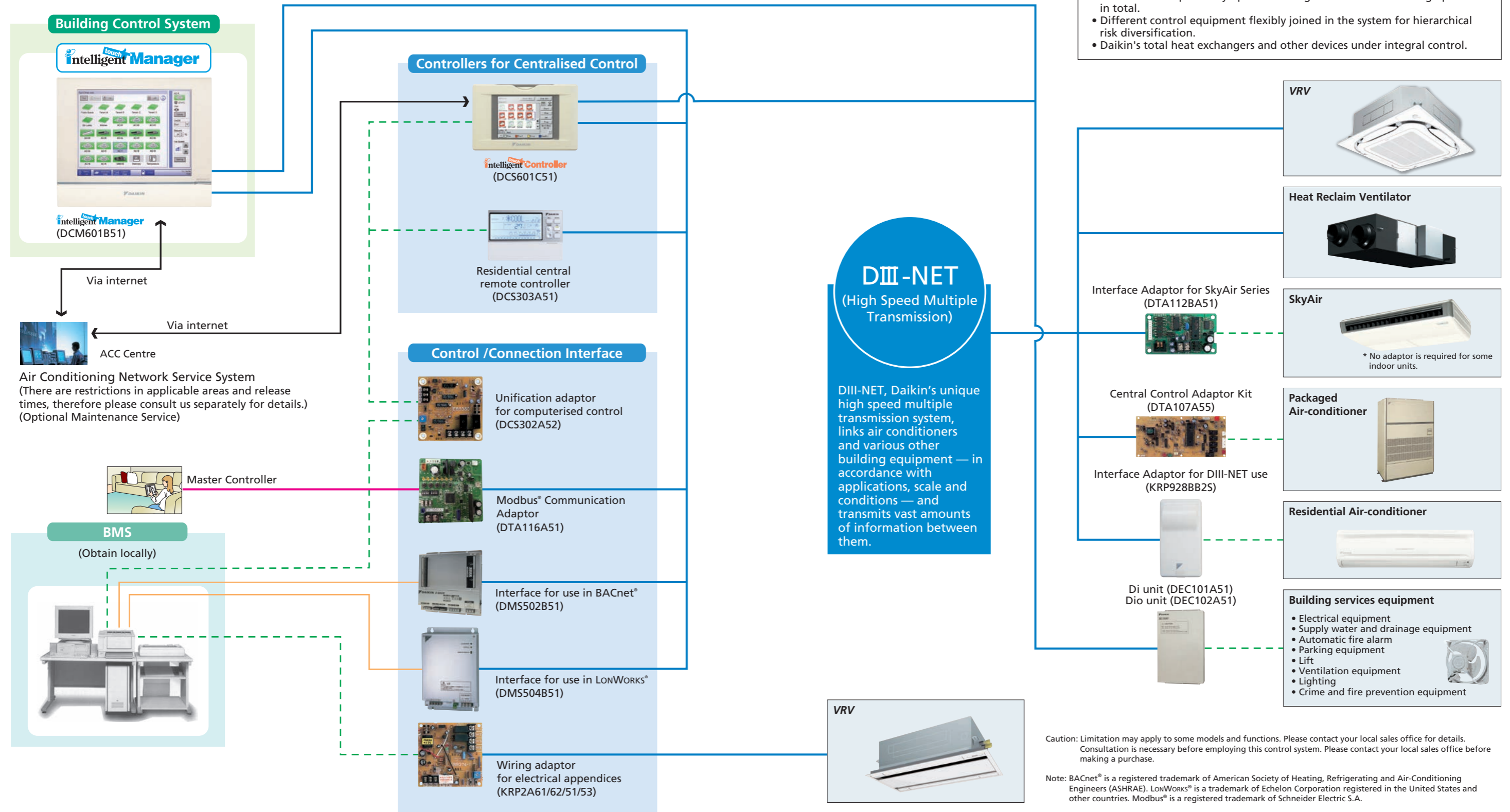

Caution: Limitation may apply to some models and functions. Please contact your local sales office for details. Consultation is necessary before employing this control system. Please contact your local sales office before making a purchase.

Note: BACnet® is a registered trademark of American Society of Heating, Refrigerating and Air-Conditioning Engineers (ASHRAE). LONWORKS® is a trademark of Echelon Corporation registered in the United States and other countries. Modbus® is a registered trademark of Schneider Electric S.A.

# Control Systems

## Advanced control systems for VRV systems



**Intelligent Touch Manager**

DCM601B51

Various types of equipment in a building can be controlled by a single controller.

### One touch selection enables flexible control of equipment in a building.

#### Individual air-conditioning control

The flexible control achieved by the VRV system precisely meets different air conditioning needs in each room (e.g. offices, conference rooms, hotel rooms).

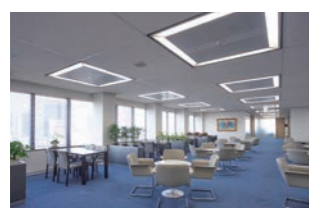

#### Lighting control **DALI-compatible**

DALI-compatible LED lighting systems can be controlled and monitored. Lighting control is enhanced through an interlock function with air conditioners and other functions.

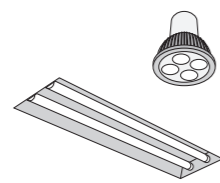

#### Air-conditioning control for large spaces

Air handling units can also be controlled. Large spaces, such as entrance halls and shopping malls, can be easily controlled to ensure comfort.

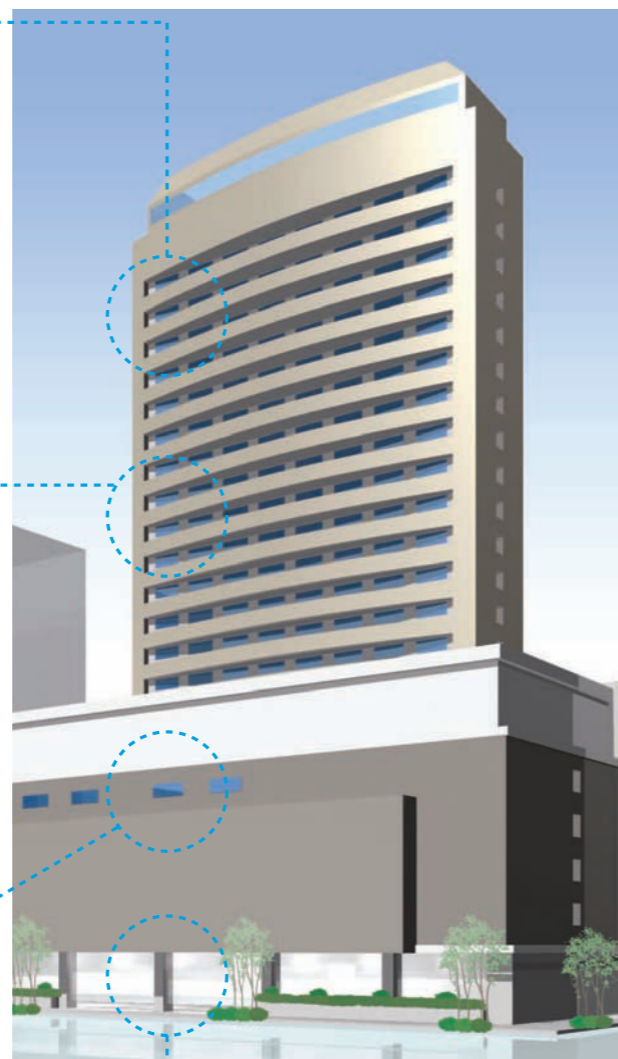

#### Building equipment control

Various types of equipment other than air conditioners, including ventilators, fans, and pumps, can also be controlled.

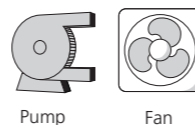

### For energy saving & comfort

*Intelligent Touch Manager* maximises the advantages of VRV features

*Intelligent Touch Manager* is an advanced multi-zone controller that provides the most cost-effective way to control and monitor the Daikin VRV system.

The 10.4" LCD touch screen is easy to use with three different screen views to include the floor plan layout view, icon view and list view and menus for system configurations.

It is also easy to use with standardized remote Web Access from your PC.

It can manage a total of 650 management points consisting of up to 512 Daikin indoor unit groups (up to 1024 indoor units) along with building equipment control / monitoring with Digital Inputs / Output (Di/Dio), Analog Inputs / Output (Ai/Ao) and Pulse input (Pi) optional devices.

Schedule the operation time for each application.

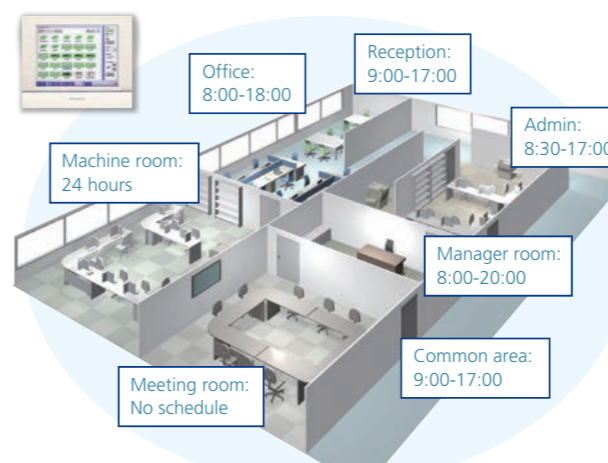

Setting the I-demand function and nighttime quiet operation function is also possible.

Turn the unit OFF if a user didn't.

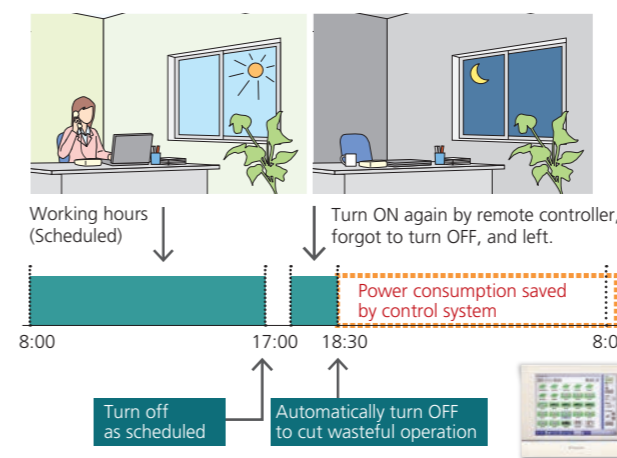

Define the setpoint range that users can change.

With Remote controller



With Control System

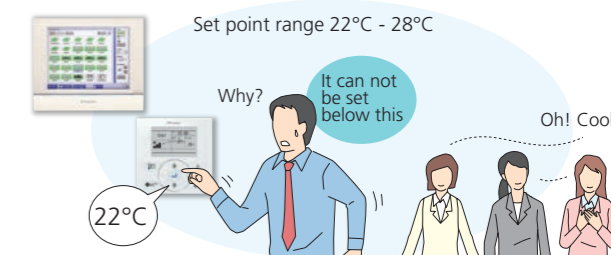

Reset setpoint regularly.

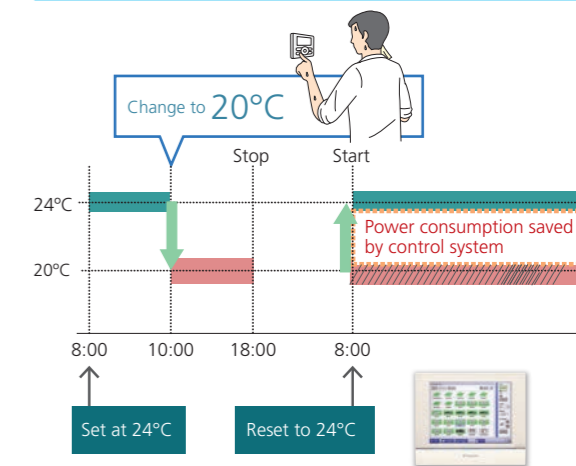

External contact demand control function

This function automatically controls outdoor and indoor unit capacity based on contact signals sent from demand controller (field supply) etc. to save power consumption during peak hours.

- You may set 3 levels that can be switched by ON/OFF signal of 3 contacts
- Control settings are pre-set for each level
- Outdoor unit: I-demand function for peak power limit
- Indoor unit: Set temperature shift, Forced thermostat OFF





## Lighting control (Option)

In addition to switching lights on and off, advanced lighting control, such as illuminance adjustment, can be achieved

Connection to DALI-compatible lighting control system

**DALI-compatible**

Please contact your local sales office for details.

Simple wiring (daisy chain) enables management of LED lighting by the *intelligent Touch Manager*. Various air conditioning and lighting control is enabled through the interlock with occupancy sensors and illuminance sensors.

### Lighting control achieved by the *intelligent Touch Manager*

#### [Operation]

- Switch-on/switch-off operation
- Illuminance (1–100%) control
- Various illuminance patterns can be registered
- Registered pattern can be selected from *intelligent Touch Manager*

#### [Monitoring]

- Switch-on/switch-off status monitoring
- Lighting abnormality monitoring
- Illuminance monitoring
- DALI occupancy sensor monitoring
- DALI illuminance sensor monitoring

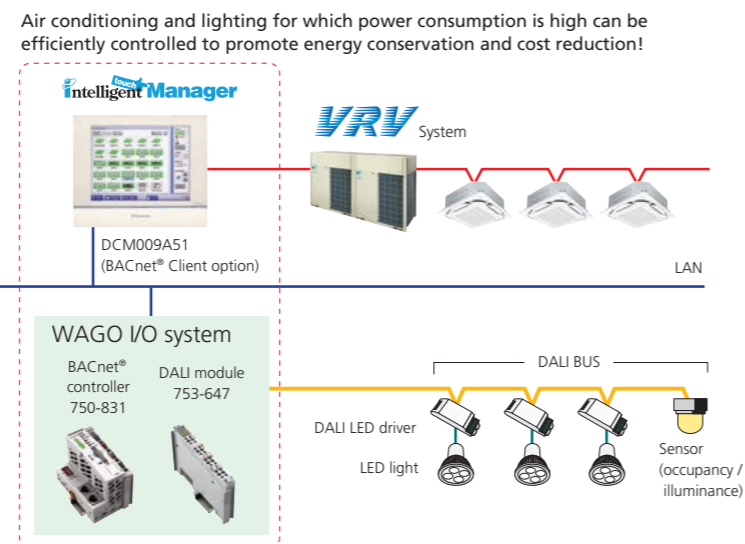

Air conditioning and lighting for which power consumption is high can be efficiently controlled to promote energy conservation and cost reduction!

### Overview of control

- Up to 5 DALI modules can be connected to a single BACnet® controller.
- Up to 64 DALI LED drivers (64 addresses) can be connected to a single DALI module.
- 64 DALI addresses can be freely assigned to up to 16 groups using a single DALI module. (Each group corresponds to a management point of the *intelligent Touch Manager*.)
- Up to 16 scenes can be set to a single DALI module.
- Up to 12 sensors (occupancy, illuminance) can be connected to a single DALI module.
- DALI BUS simplifies wiring and setting work by daisy chain wiring and automatic address setting.

## Easy maintenance and energy saving by lighting control

### Case 1

Switch-on / switch-off and illuminance are controlled based on a schedule to cut wasteful power consumption.

- Failing to switch off lights is prevented.

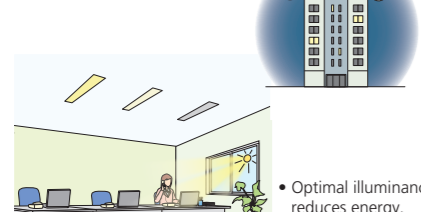

- Optimal illuminance reduces energy.

### Case 2

Occupancy sensors are used to eliminate both wasteful lighting and air conditioning. When a room is unoccupied, the air conditioning stops and the lighting is switched off.

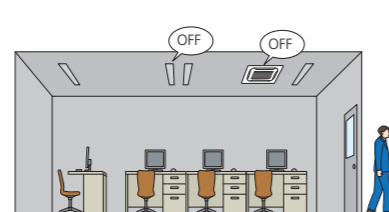

### Case 3

Lighting abnormalities (e.g. burned-out bulbs) can be checked on the *intelligent Touch Manager* screen.

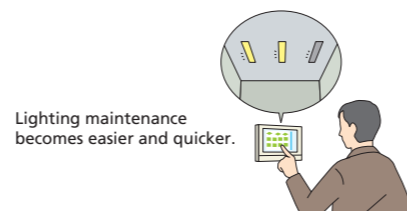

Lighting maintenance becomes easier and quicker.

The layout screen enables quick identification of specific locations.

## Tenant management

### Reporting the power consumption of VRV system for each tenant (PPD\* Option)

With the PPD function, power consumption can be calculated for each indoor unit (Option)

The energy consumption is proportionally calculated for each indoor unit. The data can be used for energy management and calculation of air conditioning usage fees for respective tenants.

Operational information of individual indoor units are monitored, based on distribution of power consumption of outdoor units.

Daikin's PPD keeps track of power distribution for each indoor unit. It performs air conditioning billing calculations quickly and automatically.

#### It is easy to output PPD data.

PPD data is output in CSV format to a PC or USB memory device and can be freely processed and managed.

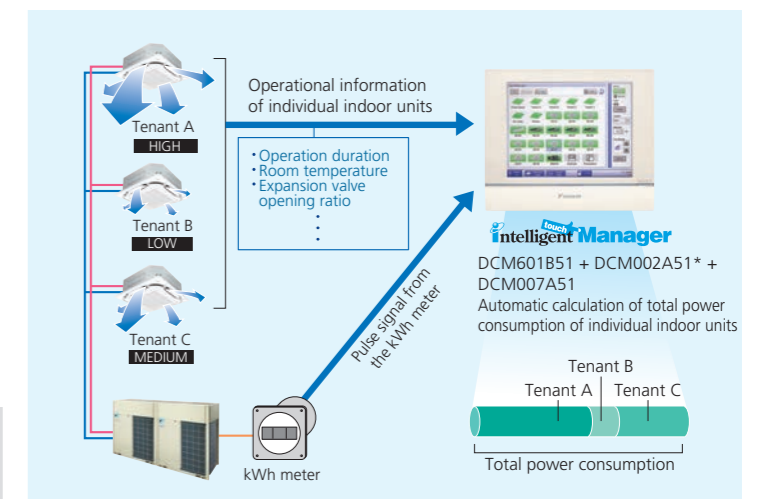

\*PPD (Power Proportional Distribution) is Daikin's proprietary calculation method.

### Air conditioning bills can be issued by one click (PPD\* Option)

Electricity bills can be easily calculated for each tenant (Option)

The power consumption of VRV controlled by the *intelligent Touch Manager* can be easily managed for each tenant using a PC. The electricity bill settings facilitate billing work through easy calculation and issuance of VRV electricity bills.

#### Main functions

- Register tenants
- Set the electricity unit price for 5 time zones
- Calculate power consumption and electricity charge for each tenant
- Show aggregation results in the specified period for each tenant
- Output the results (Printout and CSV file)

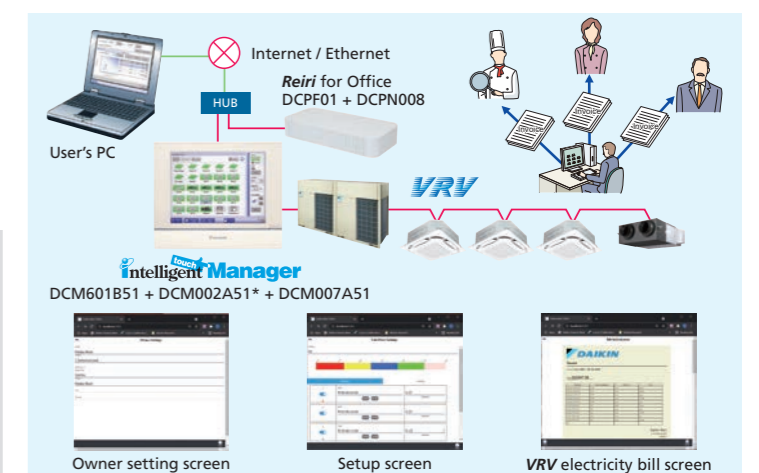

\*PPD (Power Proportional Distribution) is Daikin's proprietary calculation method.

### Effective service functions offered to tenants

Smartphone will be a remote controller of VRV system (Option)

Users can operate and check the status of VRV system from their smartphones via the internet.

It is not necessary to move where a remote controller is located with this feature. VRV system in other rooms can be operated, and their status can be checked. It is also possible to check if air conditioners in other rooms remain switched on etc., helping achieve energy saving.

#### For buildings VRV Smartphone Remote Controller

Up to 1024 indoor units can be controlled.

Just add Reiri for Office DCPF01 to this system

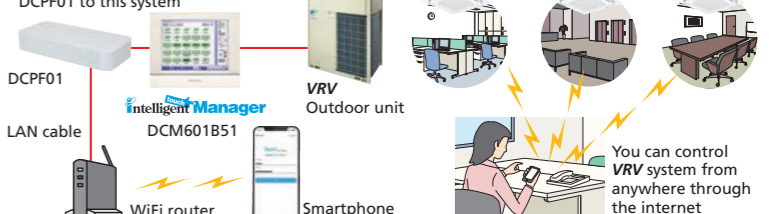



## intelligent Touch Manager system overview

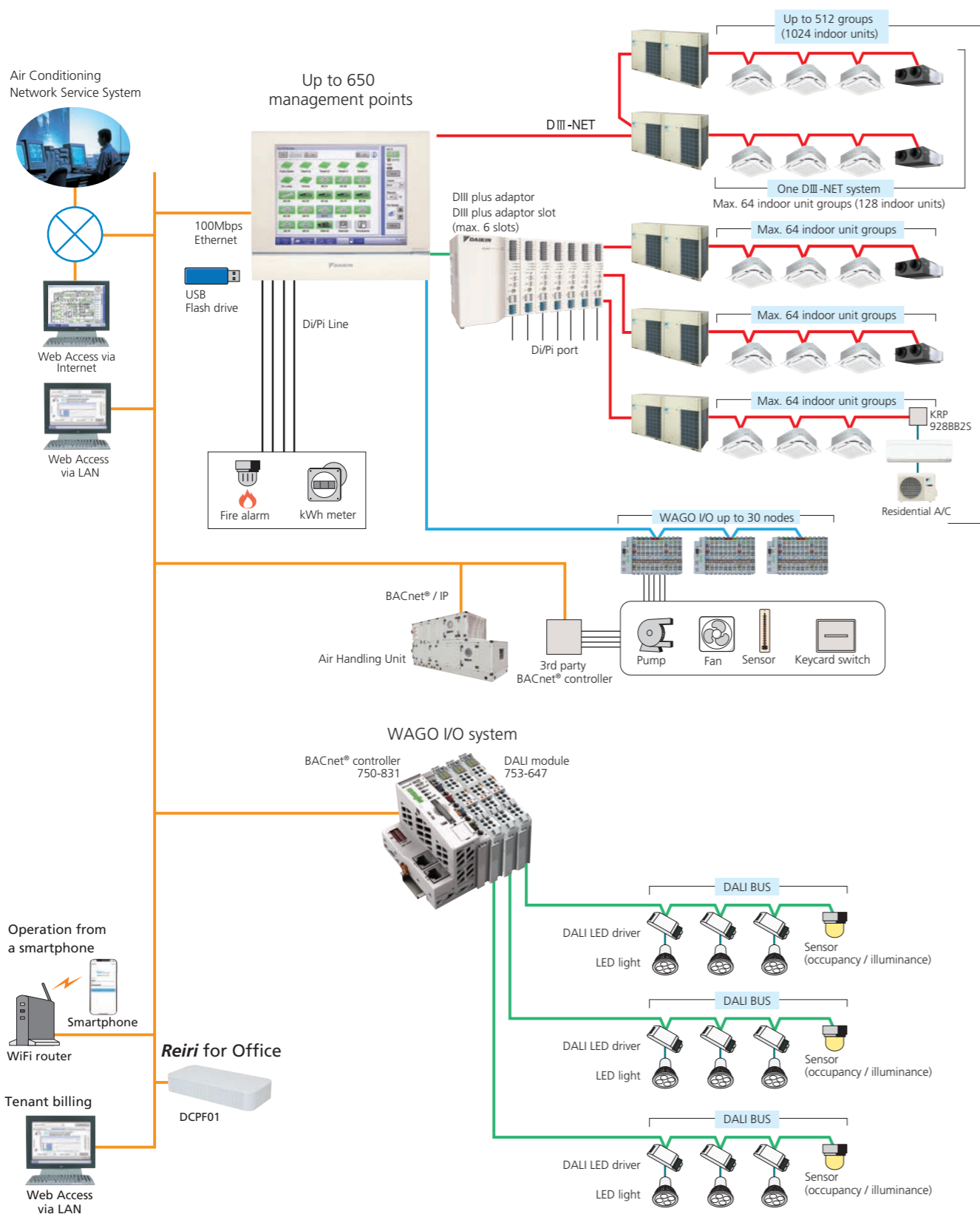

### Air conditioning network service system

#### Preventive maintenance

The *intelligent Touch Manager* can be connected to Daikin's own Air Conditioning Network Service System for remote monitoring and verification of operation status for **VRV** system. By its ability to predict malfunctions, this service provides customers with additional peace of mind.

#### Enhanced convenience with link to the Air Conditioning Network Service System

The *intelligent Touch Manager* connects seamlessly to Daikin's 24-hour Air Conditioning Network Service System.

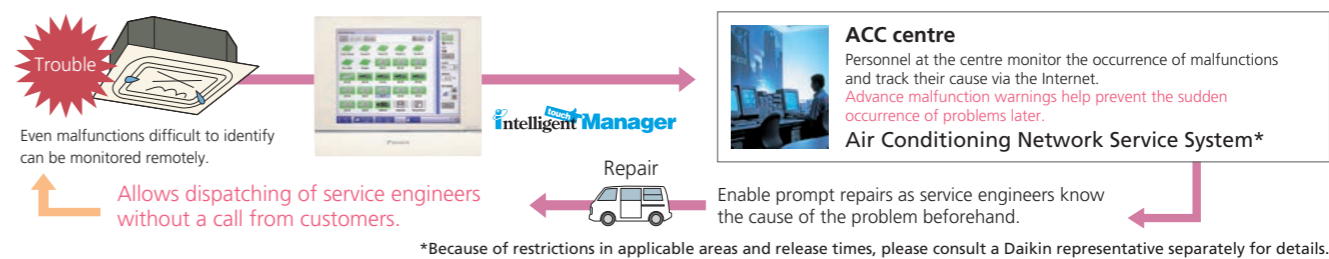

### Daikin offers a variety of control systems

#### Convenient controllers that offer more freedom to administrators

#### Ease of use and expanded control functions

The user-friendly controller features colours, multilingual function, and icons in the display for ease of understanding. A wide variety of control methods can be accommodated, permitting administrators to monitor and operate the system even when they are away from the controller.



#### Connect VRV system to your BMS via BACnet® or LONWORKS®

Compatible with BACnet® and LONWORKS®, the two leading open network communication protocols, Daikin offers interfaces that provide a seamless connection between **VRV** system and your BMS.

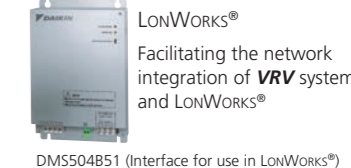
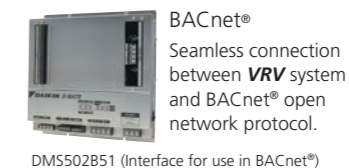

Dedicated interfaces make Daikin air conditioners freely compatible with open networks

Notes: 1. BACnet® is a registered trademark of American Society of Heating, Refrigerating and Air-Conditioning Engineers (ASHRAE).  
2. LONWORKS® is a trademark of Echelon Corporation registered in the United States and other countries.

### Specialised solution for office and home with Reiri Series

#### Catering to different applications, ranging from 10 indoor units to 2048 indoor units

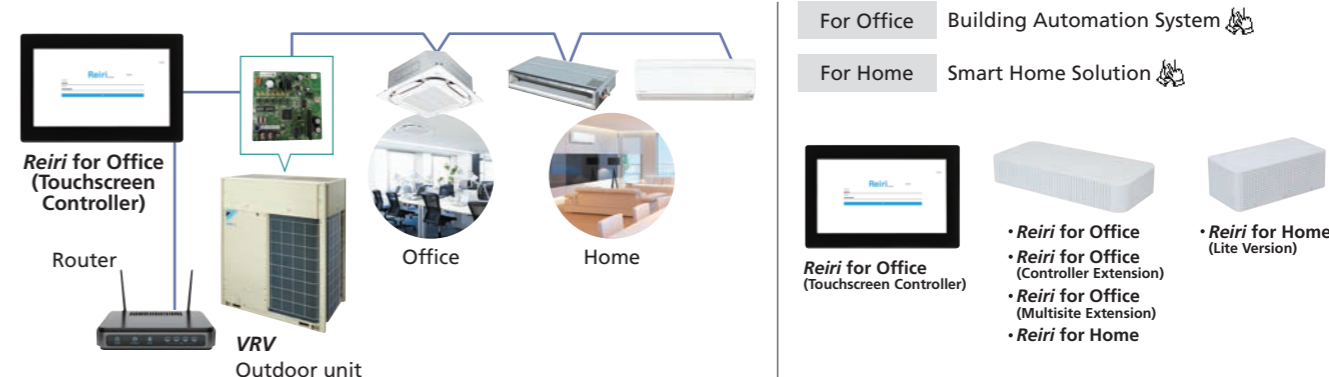

# Control Systems

## Modbus® Communication Adaptor

Image to use Modbus® Communication Adaptor DTA116A51

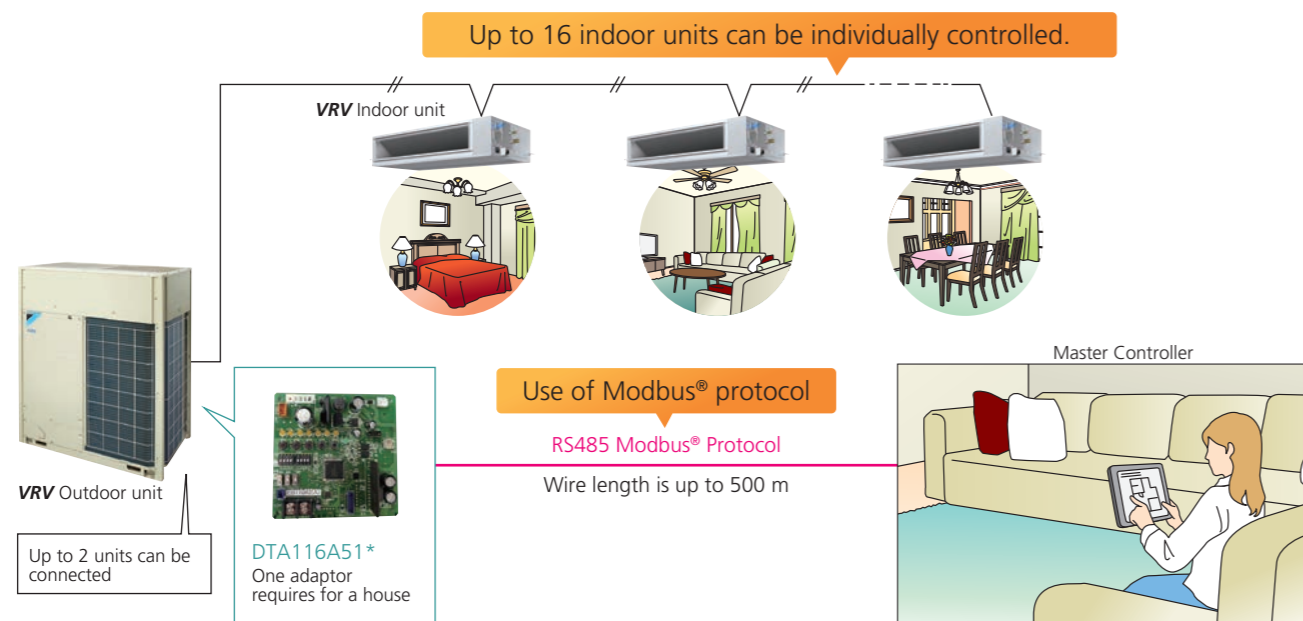

\*A separate power supply for Home Automation Interface Adaptor is necessary. It may not be installed inside some outdoor unit models.

### Functions Monitor

On/Off	On/Off status of indoor units
Operation mode	Cooling, Heating, Fan, Dry, Auto (depend on indoor unit capability)
Setpoint	Setpoint of indoor units
Room temperature	Suction temperature of indoor units
Fan direction	Swing, Flap direction (depend on indoor unit capability)
Fan volume	L, M, H (depend on indoor unit capability)
Forced off status	Forced off status of indoor units
Error	Malfunction, Warning with Error code
Filter sign	Filter sign of indoor units
Communication status	Communication normal/error of indoor units

### Control

On/Off	On/Off control of indoor units
Operation mode	Cooling, Heating, Fan, Dry, Auto (depend on indoor unit capability)
Setpoint	Cooling/Heating setpoint
Fan direction	Swing, Stop, Flap direction (depend on indoor unit capability)
Fan volume	L, M, H (depend on indoor unit capability)
Filter sign reset	Reset filter sign of indoor units

### Retrieve system information

Connected indoor units	DIII -NET address of connected indoor units can be retrieved.
Indoor unit capabilities	Indoor unit capabilities such as operation mode, fan control, setpoint HV can be retrieved.

\* Modbus® is a registered trademark of Schneider Electric S.A.

## Complete control system for VRV systems



High value smart solution creation for different application

### Office Air Conditioning Solution (Reiri for Office :DCPF01 / Reiri for Office (Touchscreen Controller) :DCPF04-AU)

A simple office buildings air conditioning solution with a secured, cloud enabled platform, allowing greater ease of control and control while being energy-efficient. The flagship model DCPF04-AU offers the smart control system with a dedicated touch panel.

### Intelligent Building Solution

- Easy to install and configure with dedicated Configuration Mobile App for installers.
- Remote control operation through mobile App from anywhere.
- Energy management through P.P.D. billing, Energy graph and real time energy display function
- IAQ Management via real time monitoring and trend graph for keeping record.
- Effective Air conditioning usage with setpoint range limitation, set back function, remote control prohibition.

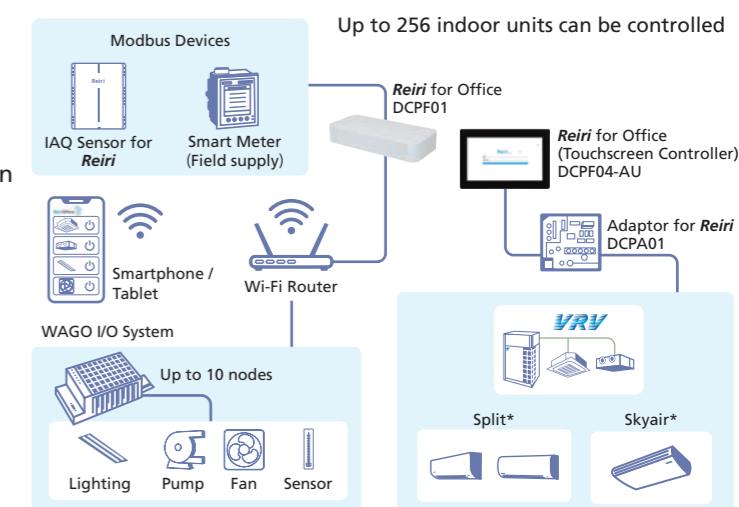

\*Additional Interface Adaptors may be required.

### Specifications

Category	Function	Description
Monitoring & Control	Status monitoring	On/Off, setpoint, operation mode, fan step, flap, error, error code, Room temperature
	Manual Operation	On/off, setpoint, operation mode, fan step, flap, scene control <sup>1</sup>
	Remote control prohibition	Individually prohibit operation of each local remote-control function
	Setpoint range limitation	To limit setpoint range for each indoor unit management point
Automatic Control functions	Automatic changeover <sup>1</sup>	Number of changeover groups: 100
	Off timer	Off timer duration can set from 5min to 120min with every 5min interval
	Setback <sup>1</sup>	Setback setpoint can selected within 24-35°C in cooling mode and 5-20°C in heating mode.
	Schedule	Number of programmes: 100; Up to 20 actions can be registered per pattern.
Data Management	Interlock <sup>1</sup>	Interlock operation depending on equipment status
	History, Report <sup>1</sup>	Operation data (latest information and operation report) and error report on daily/monthly basis.
	Trend graph <sup>1</sup> , energy graph <sup>1</sup>	Chart on environmental changes and energy (and other meter) values.
P.P.D Billing <sup>1,2</sup>	Real time energy display <sup>1,2</sup>	Daily/ Monthly real time energy consumption status on screen.
		Generate Bill with Power Proportional Distribution data retrieved from the system.
System Setting		Language, Password setting, Account setting, Notification, Email Notification

<sup>1</sup> Optional software for Reiri for Office, DCPF01

<sup>2</sup> Optional software for Reiri for Office (Touchscreen Controller), DCPF04-AU

## Office Expanded Solution (*Reiri* for Office (Controller Extension) :DCPF05)

A dedicated control solution for large scale office buildings through centralised control of multiple *Reiri* for Office controller on a single secured and cloud-enabled platform.

Note: P.P.D. & Tenant Billing Management and Real-Time Energy Monitoring (R.E.M.) are offered as optional software.

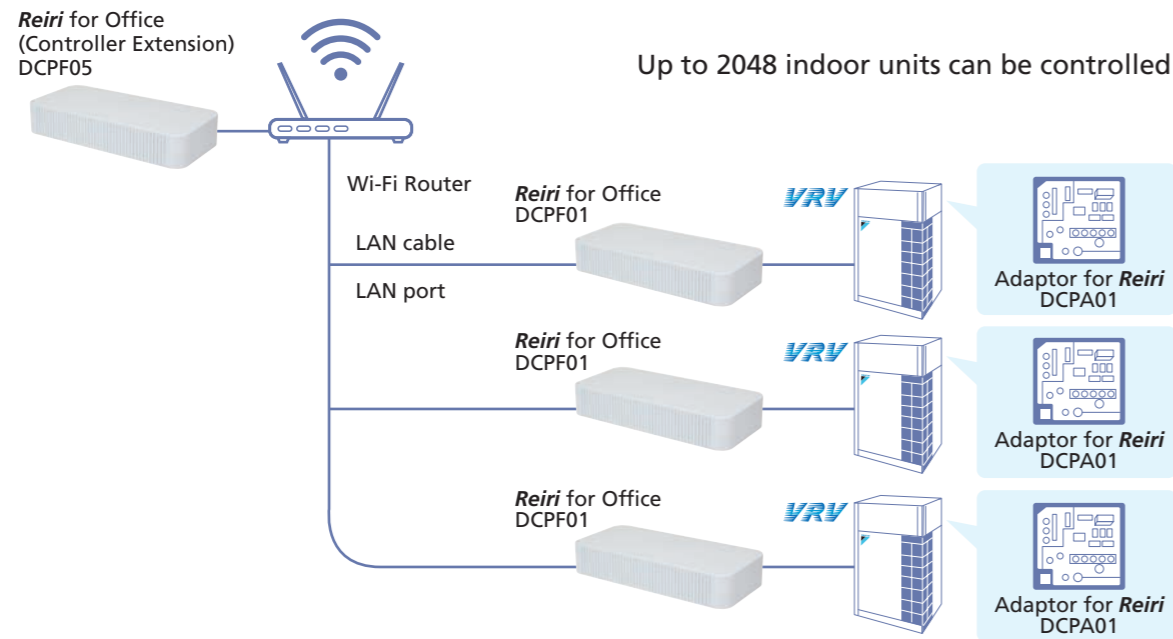

## Multi Site Management Solution (*Reiri* for Office (Multisite Extension) :DCPF10)

Centralised control and remote access for all devices in multiple buildings across different locations conveniently located on one secured platform.

Note: Multi-site Branch Expansion is offered as optional software.

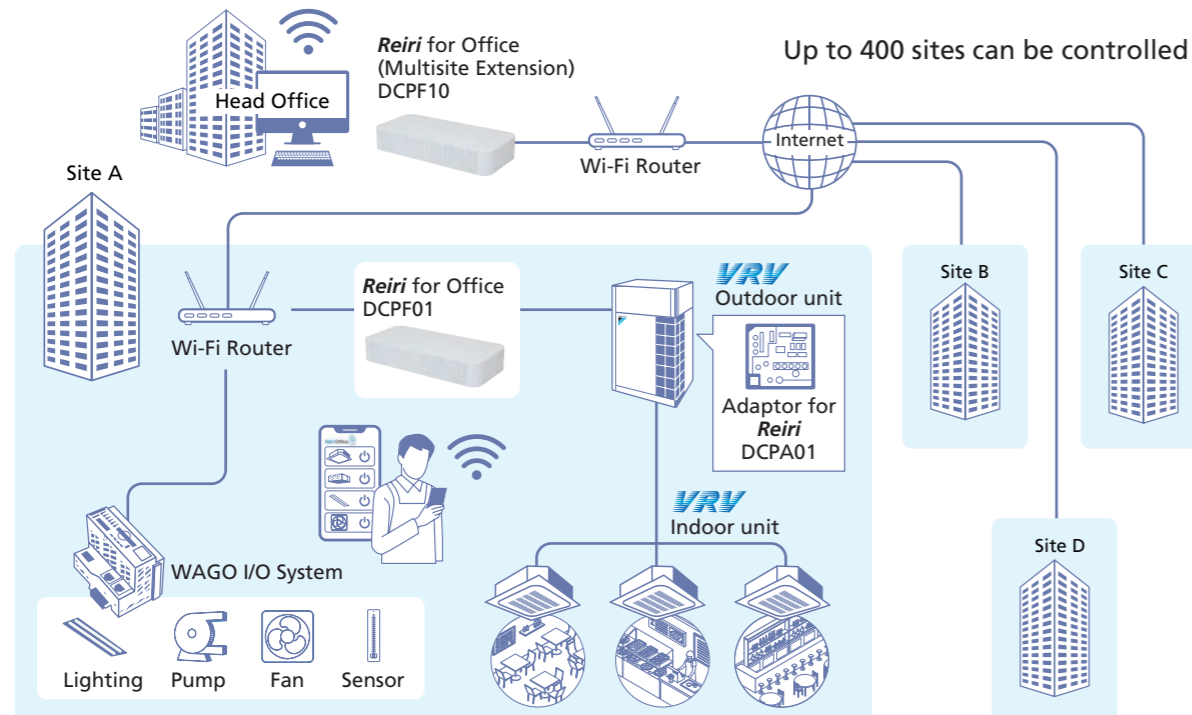

## Smart Home Solution (*Reiri* for Home :DCPH01)

The complete smart home air conditioning solution for every homeowners with integration capabilities to allow ease and convenience of control for almost every smart devices

### Complete Smart Home Solution

- Supports, WAGO, Modbus, LAN communication
- Convenience & Lifestyle
- IAQ Management
- Energy Management
- Home Security Solution
- Google Home Enabled

Note: Residential automatic control and system report is offered as optional software.

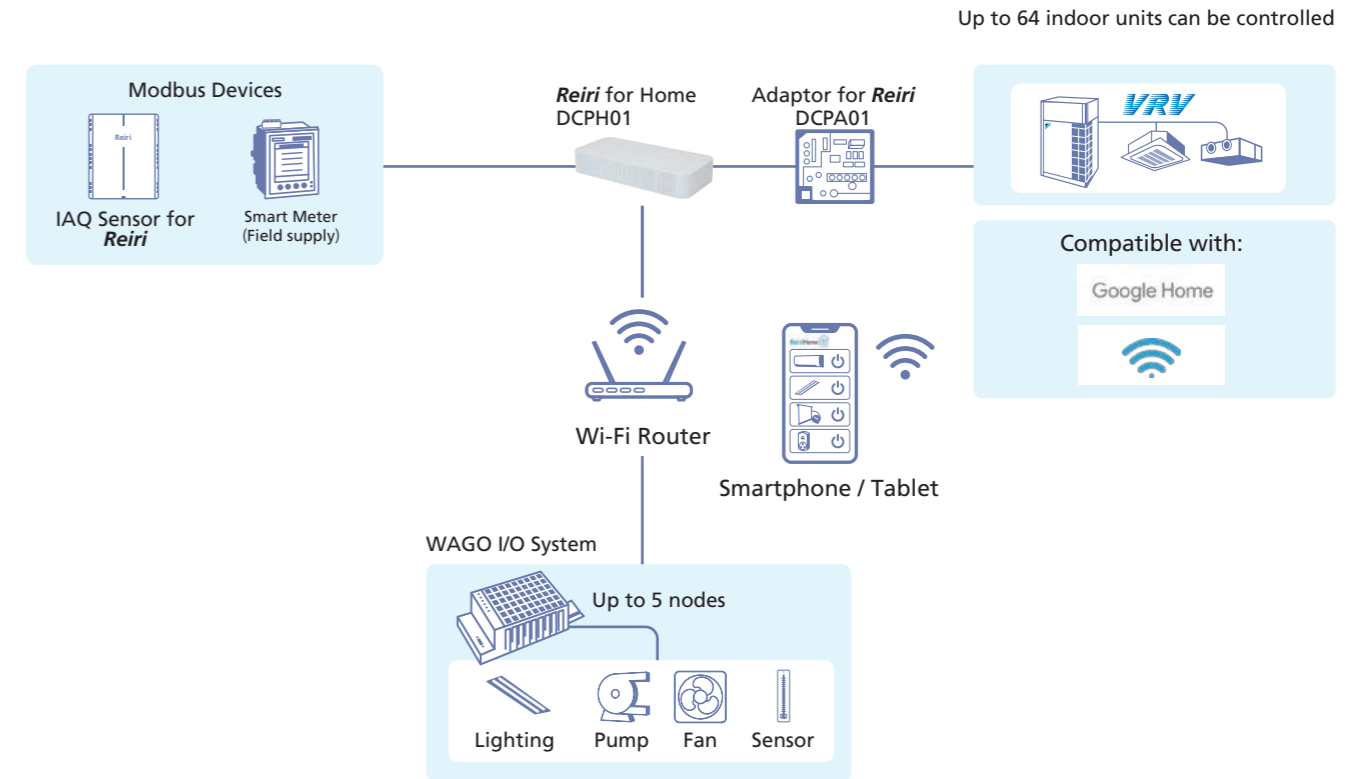

## VRV Smart Centralised Control Solution (*Reiri* for Home (Lite Version) :DCPH02)

Designed to enhance the comfort and convenience for homeowners, offering complete control of core functions in Daikin Airconditioning system remotely through app access

Note: Residential automatic control and system report is offered as optional software.

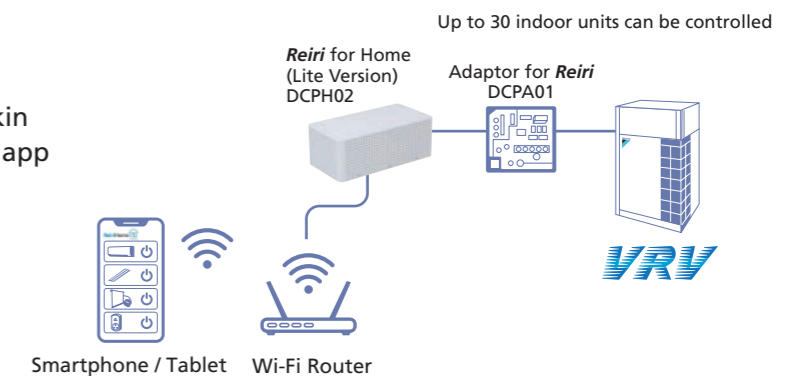



# Header Pack (Packaged Refnet Headers)

## Save installation time

Indoor unit piping work can be easier and quicker.



## A smarter way to connect refrigerant piping



**HEADER PACK**

- ✓ Time Saver using Quick Flare Nut Connection
- ✓ Space Saving with Compact Design
- ✓ Connects up to 4 and 6 indoor units

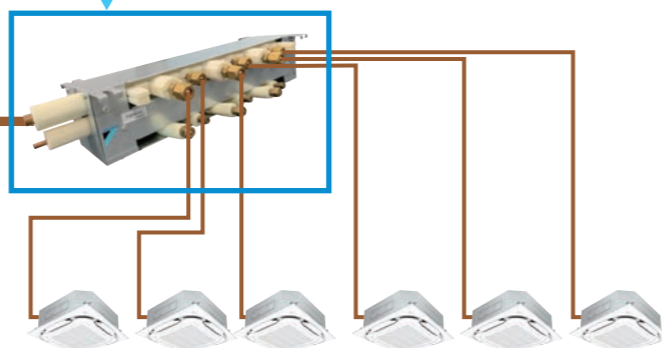

**Reliability improvement**  
Easy piping installation that anyone can do

**Installation improvement**  
Faster work with simplified installation using basic tools

## Suitable luxions residence

Simple & Quick!

Easy piping connection / Easy installation

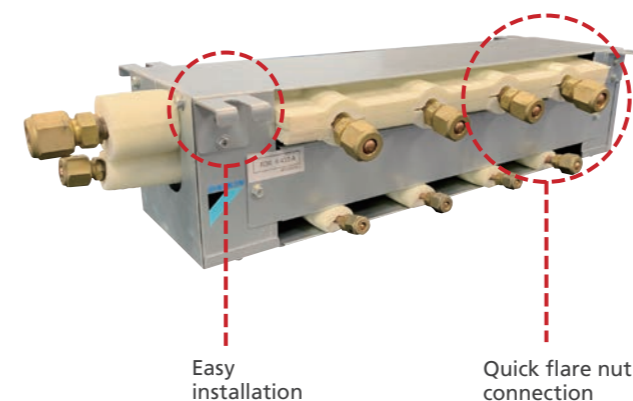

Reduction of connection points by elimination of refnet joints

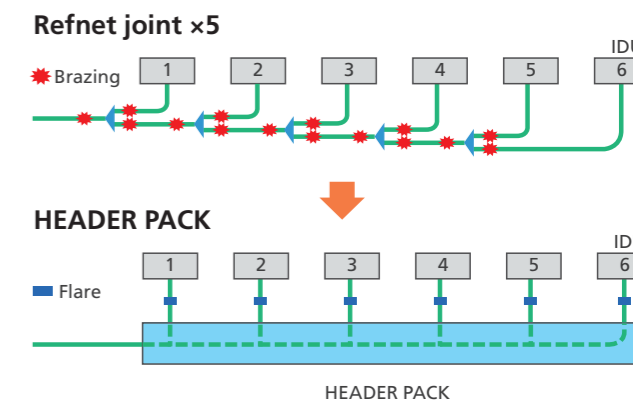

### Advantages

Easy to install with no brazing required

Save more than 60% installation time

Safe to use with no fire hazard danger in the building

Space saving with attic height reduced by 300 mm

• Connectable up to 4 & 6 IDU



### HEADER PACK Lineup

Model name	Outdoor unit side		Indoor unit side (Flare)		Indoor unit total capacity index	Dimension (mm)		
	Liquid / Gas (mm)		Port	Liquid / Gas (mm)		H	D	W
BHF6RHP6Z	9.5 / 15.9 (Flare)	4	Large x1 Small x3	φ9.5 / φ 15.9 φ6.4 / φ 12.7	≤ 150	135	143	559
BHF6ARHP6Z	9.5 / 15.9 (Flare)	6	Large x2 Small x4	φ9.5 / φ 15.9 φ6.4 / φ 12.7	≤ 150	135	143	623
BHF8RHP6Z	9.5 / 19.1 (Daikin Gas Tight Joint)	6	Large x3 Small x3	φ9.5 / φ 15.9 φ6.4 / φ 12.7	≤ 200	135	143	623
BHF10RHP6Z	9.5 / 22.2 (Daikin Gas Tight Joint)	6	Large x3 Small x3	φ9.5 / φ 15.9 φ6.4 / φ 12.7	< 290	135	143	623
BHF16RHP6Z	12.7 / 28.6 (Daikin Gas Tight Joint)	6	Large x3 Small x3	φ9.5 / φ 15.9 φ6.4 / φ 12.7	< 420	135	143	623

### Dimensions (Top view)

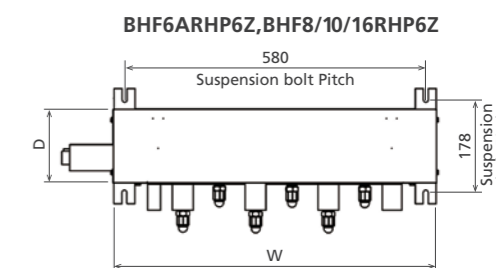
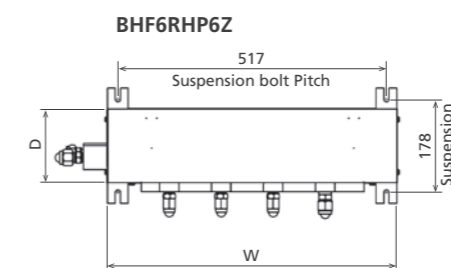

# Option List

## Outdoor units

### VRV R SERIES

No.	Item		Type	REYQ8B	REYQ18B	REYQ26B	REYQ38B	REYQ50B	REYQ56B
				REYQ10B	REYQ20B	REYQ28B	REYQ40B	REYQ52B	REYQ58B
				REYQ12B	REYQ22B	REYQ30B	REYQ42B	REYQ54B	REYQ60B
				REYQ14B	REYQ24B	REYQ32B	REYQ44B	REYQ54B	REYQ60B
				REYQ16B		REYQ34B	REYQ46B	REYQ54B	REYQ60B
						REYQ36B	REYQ48B		
1	3 Pipes	REFNET header	KHRP25M33H(Max. 8 branch), KHRP25M72H(Max. 8 branch), KHRP25M73H(Max. 8 branch)						
		REFNET joint	BHRP25A22T, BHRP25A33T, BHRP25A72T, BHRP25A73T						
		Pipe size reducer	KHRP25M72TP, KHRP25M73TP						
	2 Pipes	REFNET header	KHRP26M22H(Max. 4 branch), KHRP26M33H(Max. 8 branch), KHRP26M72H(Max. 8 branch), KHRP26M73H(Max. 8 branch)						
		REFNET joint	BHRP26A22TA, BHRP26A33TA, BHRP26A72TA, BHRP26A73TA						
		Pipe size reducer	KHRP26M73HP						
2	Outdoor unit multi connection piping kit					BHFP26R135			BHFP26R168

Note: \*1. The appropriate REFNET parts should be selected to match the total capacity index of indoor units connected below each REFNET, based on the installation manual.

**REFNET joint**  
(BHRP25A22/33/72/73T, BHRP26A22/33/72/73TA)



### Option PCB

No.	Item		Type	REYQ8B	REYQ16B	REYQ24B	REYQ32B	REYQ40B	REYQ48B	REYQ56B
				REYQ10B	REYQ18B	REYQ26B	REYQ34B	REYQ42B	REYQ50B	REYQ58B
				REYQ12B	REYQ20B	REYQ28B	REYQ36B	REYQ44B	REYQ52B	REYQ60B
				REYQ14B	REYQ22B	REYQ30B	REYQ38B	REYQ46B	REYQ54B	
1	DIII-NET expand adaptor + Wire harness adaptor kit			DTA109A51 + BER11A						
2	External control adaptor			DTA104A62						

### VRV H SERIES

No.	Item		Type	RXYQ8B	RXYQ18B	RXYQ26B	RXYQ38B	RXYQ50B	RXYQ56B
				RXYQ10B	RXYQ20B	RXYQ28B	RXYQ40B	RXYQ52B	RXYQ58B
				RXYQ12B	RXYQ22B	RXYQ30B	RXYQ42B	RXYQ54B	RXYQ60B
				RXYQ14B	RXYQ24B	RXYQ32B	RXYQ44B	RXYQ54B	RXYQ60B
				RXYQ16B		RXYQ34B	RXYQ46B	RXYQ54B	RXYQ60B
						RXYQ36B	RXYQ48B		
1	Distributive piping*1	REFNET header	KHRP26M22H(Max. 4 branch), KHRP26M33H(Max. 8 branch), KHRP26M72H(Max. 8 branch), KHRP26M73H(Max. 8 branch)						
		REFNET joint	BHRP26A22TA, BHRP26A33TA, BHRP26A72TA, BHRP26A73TA						
		Pipe size reducer	KHRP26M73HP						
2	Outdoor unit multi connection piping kit						BHFP22R135		BHFP22R168

Note: \*1. The appropriate REFNET parts should be selected to match the total capacity index of indoor units connected below each REFNET, based on the installation manual.

**REFNET joint**  
(BHRP26A22/33/72/73TA)



### Option PCB

No.	Item		Type	RXYQ8B	RXYQ16B	RXYQ24B	RXYQ32B	RXYQ40B	RXYQ48B	RXYQ56B
				RXYQ10B	RXYQ18B	RXYQ26B	RXYQ34B	RXYQ42B	RXYQ50B	RXYQ58B
				RXYQ12B	RXYQ20B	RXYQ28B	RXYQ36B	RXYQ44B	RXYQ52B	RXYQ60B
				RXYQ14B	RXYQ22B	RXYQ30B	RXYQ38B	RXYQ46B	RXYQ54B	
1	DIII-NET expand adaptor + Wire harness adaptor kit			DTA109A51 + BER11A						
2	External control adaptor			DTA104A62						

# Option List

## Outdoor units

### VRV S High Seasonal Efficiency SERIES

No.	Item	Type	RSUYQ4A2	RSUYQ5A2	RSUYQ6A2	RSUYQ7A	RSUYQ8A
1	Header pack		BHF6RHP6Z, BHF6ARHP6Z, BHF8RHP6Z				
2	REFNET header		KHRP26M22H (Max. 4 branch) , KHRP26M33H (Max. 8 branch)				
3	REFNET joint		BHRP26A22TA		BHRP26A22TA, BHRP26A33TA		
4	Drain plug		BKP082A41				
5	Air direction adjustment grille		KPW082A41				

### Option PCB

No.	Item	Type	RSUYQ4A2	RSUYQ5A2	RSUYQ6A2	RSUYQ7A	RSUYQ8A
1	DIII-NET expander adaptor ★			—		DTA109A51	
2	External control adaptor ★			—		DTA104A61	
3	Modbus® Communication Adaptor ★			—		DTA116A51	
4	Option plate for control adaptor			—		BKS26C*1	

Note: \*1. This plate is necessary for each adaptor marked ★.

### VRV IV S SERIES

No.	Item	Type	RXYMQ3A2	RXYMQ4A2	RXYMQ5B2	RXYMQ6B2	RXYMQ8A	RXYMQ9A
1	Header pack		BHF6RHP6Z, BHF6ARHP6Z, BHF8RHP6Z					
2	Cool/Heat selector		KRC19-26A		—			
2-1	Fixing box		KJB111A		—			
3	REFNET header		KHRP26M22H (Max. 4 branch), KHRP26M33H (Max. 8 branch)					
4	REFNET joint		KHRP26A22T			KHRP26A22T, KHRP26A33T		
5	Central drain plug		KKPJ5H280					
6	Fixture for preventing overturning		KKT5B112					
7	Wire fixture for preventing overturning		—			K-KYZP15C		

### VRV IV Q SERIES Standard Type

No.	Item	Type	RQYQ6T(E) RQYQ8T(E) RQYQ10T(E)	RQYQ12T(E) RQYQ14T(E) RQYQ16T(E)
1	Distributive piping	REFNET header	KHRP26M22H, KHRP26M33H (Max. 4 branch), (Max. 8 branch)	KHRP26M22H, KHRP26M33H, KHRP26M72H (Max. 4 branch) (Max. 8 branch) (Max. 8 branch)
		REFNET joint	BHRP26A22TA, BHRP26A33TA	BHRP26A22TA, BHRP26A33TA, BHRP26A72TA
2	Cool / Heat selector		KRC19-26A	

No.	Item	Type	RQYQ18TN(E) RQYQ20TN(E) RQYQ22TN(E)	RQYQ24TN(E) RQYQ26TN(E) RQYQ28TN(E)	RQYQ30TN(E) RQYQ32TN(E)
1	Distributive piping	REFNET header	KHRP26M22H, KHRP26M33H (Max. 4 branch) (Max. 8 branch), KHRP26M72H (Max. 8 branch)	KHRP26M22H, KHRP26M33H, (Max. 4 branch) (Max. 8 branch) KHRP26M72H, KHRP26M73H (Max. 8 branch) (Max. 8 branch)	
		REFNET joint	BHRP26A22TA, BHRP26A33TA, BHRP26A72TA	BHRP26A22TA, BHRP26A33TA, BHRP26A72TA, BHRP26A73TA	
2	Pipe size reducer		—	KHRP26M73HP	
3	Outdoor unit multi connection piping kit		BHFP22P100		
4	Cool / Heat selector		KRC19-26A		

No.	Item	Type	RQYQ34TN(E) RQYQ36TN(E)	RQYQ38TN(E) RQYQ40TN(E)	RQYQ42TN(E) RQYQ44TN(E)	RQYQ46TN(E) RQYQ48TN(E)
1	Distributive piping	REFNET header	KHRP26M22H, KHRP26M33H, KHRP26M72H, KHRP26M73H (Max. 4 branch) (Max. 8 branch) (Max. 8 branch) (Max. 8 branch)			
		REFNET joint	BHRP26A22TA, BHRP26A33TA, BHRP26A72TA, BHRP26A73TA			
2	Pipe size reducer		KHRP26M73HP			
3	Outdoor unit multi connection piping kit		BHFP22P151			
4	Cool / Heat selector		KRC19-26A			

### VRV IV Q SERIES Space Saving Type

No.	Item	Type	RQYQ18T(E) RQYQ20T(E)
1	Distributive piping	REFNET header	KHRP26M22H, KHRP26M33H, KHRP26M72H (Max.4 branch) (Max.8 branch) (Max.8 branch)
		REFNET joint	BHRP26A22TA, BHRP26A33TA, BHRP26A72TA
2	Cool / Heat selector		KRC19-26A

No.	Item	Type	RQYQ30TS(E) RQYQ32TS(E) RQYQ34TS(E)	RQYQ36TS(E) RQYQ38TS(E) RQYQ40TS(E)	RQYQ42TS(E) RQYQ44TS(E)	RQYQ46TS(E) RQYQ48TS(E)
1	Distributive piping	REFNET header	KHRP26M22H, KHRP26M33H, KHRP26M72H, KHRP26M73H (Max.4 branch) (Max.8 branch) (Max.8 branch) (Max.8 branch)			
		REFNET joint	BHRP26A22TA, BHRP26A33TA, BHRP26A72TA, BHRP26A73TA			
2	Pipe size reducer		KHRP26M73HP			
3	Outdoor unit connection piping kit		BHFP22P100		BHFP22P151	
4	Cool / Heat selector		KRC19-26A			



# Option List

## Outdoor units

### VRV III-Q

No.	Type		RQCEQ280P RQCEQ360P	RQCEQ460P RQCEQ500P	RQCEQ540P RQCEQ636P	RQCEQ712P RQCEQ744P RQCEQ816P RQCEQ848P
	Item					
1	Distributive piping	REFNET header	KHRP25M33H (Max. 8 branch) KHRP25M72H (Max. 8 branch) KHRP26M22H (Max. 4 branch) KHRP26M33H (Max. 8 branch)	KHRP25M33H (Max. 8 branch) KHRP25M72H (Max. 8 branch) KHRP25M73H (Max. 8 branch) KHRP26M22H (Max. 4 branch) KHRP26M33H (Max. 8 branch)	KHRP25M33H (Max. 8 branch) KHRP25M72H (Max. 8 branch) KHRP25M73H (Max. 8 branch) KHRP26M22H (Max. 4 branch) KHRP26M33H (Max. 8 branch) KHRP26M72H (Max. 8 branch)	KHRP25M33H (Max. 8 branch) KHRP25M72H (Max. 8 branch) KHRP25M73H (Max. 8 branch) KHRP26M22H (Max. 4 branch) KHRP26M33H (Max. 8 branch) KHRP26M72H (Max. 8 branch)
		REFNET joint	BHRP25A22T (Max. 4 branch) BHRP25A33T (Max. 8 branch) BHRP25A72T (Max. 8 branch) BHRP26A22TA (Max. 4 branch) BHRP26A33TA (Max. 8 branch)	BHRP25A22T (Max. 4 branch) BHRP25A33T (Max. 8 branch) BHRP25A72T (Max. 8 branch) BHRP25A73T (Max. 8 branch) BHRP26A22TA (Max. 4 branch) BHRP26A33TA (Max. 8 branch)	BHRP25A22T (Max. 4 branch) BHRP25A33T (Max. 8 branch) BHRP25A72T (Max. 8 branch) BHRP25A73T (Max. 8 branch) BHRP26A22TA (Max. 4 branch) BHRP26A33TA (Max. 8 branch) BHRP26A72TA (Max. 8 branch)	
2	Outdoor unit multi connection piping kit		BHFP26P36C	BHFP26P63C	BHFP26P84C	
3	Digital pressure gauge kit		BHGP26A1x2	BHGP26A1x3	BHGP26A1x4	

### VRV IV W SERIES

No.	Type		RWEYQ6T2	RWEYQ8T RWEYQ10T RWEYQ12T	RWEYQ14T RWEYQ16T RWEYQ18T RWEYQ20T RWEYQ22T RWEYQ24T	RWEYQ26T RWEYQ28T RWEYQ30T RWEYQ32T RWEYQ34T RWEYQ36T
	Item					
1	Cool/heat selector		KRC19-26A (Applies to heat pump type only)			
1-1	Fixing box		KJB111A (Applies to heat pump type only)			
2	Distributive piping	REFNET header	KHRP25M33H (Max. 8 branch), KHRP26M22H (Max. 4 branch), KHRP26M33H (Max. 8 branch)	KHRP25M33H (Max. 8 branch), KHRP25M72H (Max. 8 branch), KHRP26M22H (Max. 4 branch), KHRP26M33H (Max. 8 branch)	KHRP25M33H (Max. 8 branch), KHRP25M72H (Max. 8 branch), KHRP25M73H (Max. 8 branch), KHRP26M22H (Max. 4 branch), KHRP26M33H (Max. 8 branch), KHRP26M72H (Max. 8 branch)	KHRP25M33H (Max. 8 branch), KHRP25M72H (Max. 8 branch), KHRP25M73H (Max. 8 branch), KHRP26M22H (Max. 4 branch), KHRP26M33H (Max. 8 branch), KHRP26M72H (Max. 8 branch)
		REFNET joint	BHRP25A22T, BHRP25A33T, BHRP26A22TA, BHRP26A33TA	BHRP25A22T, BHRP25A33T, BHRP25A72T, BHRP26A22TA, BHRP26A33TA, BHRP26A72TA	BHRP25A22T, BHRP25A33T, BHRP25A72T, BHRP25A73T, BHRP26A22TA, BHRP26A33TA, BHRP26A72TA, BHRP26A73TA	
3	Outside unit multi connection piping kit	For heat pump	—	BHFP22MA56	BHFP22MA84	
		For heat recovery	—	BHFP26MA56	BHFP26MA84	
4	External control adaptor		—	DTA104A62		
5	Strainer kit		BWU26A15, BWU26A20			

Note: ★1 In the case of heat recovery system, cool/heat selector cannot be connected.

### VRV IV W SERIES Strainer kit specifications

Model	BWU26A15		BWU26A20	
Pressure resistance	MPa	1.47	1.96	
Mesh size		50	50	
Connection diameter		PT1 1/4B internal thread	PT1 1/4B internal thread	

### VRV WS SERIES

No.	Item	Type	RWXYQ3A	RWXYQ4A	RWXYQ5A	RWXYQ6A
1	Distributive piping	REFNET header	KHRP26M22H, KHRP26M33H (Max. 4 branch) (Max. 8 branch)			
		REFNET joint	BHRP26A22TA			

## VRV indoor units

### Round Flow Cassette with Sensing and Streamer Type



No.	Type		FXFTQ25A FXFTQ32A FXFTQ40A	FXFTQ50A FXFTQ63A FXFTQ80A	FXFTQ100A FXFTQ125A FXFTQ140A
	Item				
1	Decoration panel	Standard panel with sensing	Fresh white	BYCQ125EEF	
			Black	BYCQ125EEK	
		Standard panel	Fresh white	BYCQ125EAF *	
			Black	BYCQ125EAK *	
		Auto grille panel <sup>1,2</sup>	Fresh white	BYCQ125EBSF *	
2	Panel spacer		KDB55160F		
3	Fresh air intake kit	Chamber type <sup>4,5</sup>	Without T-duct joint	KDDP55C160 (Components: KDDP55C160-1, KDDP55C160-2) <sup>7</sup>	
			With T-duct joint	KDDP55C160K (Components: KDDP55C160-1, KDDP55C160K2) <sup>7</sup>	
		Direct installation type <sup>6</sup>	KDDP55X160A		
4	High performance prefilter (MERV 8) <sup>8</sup>		BAF552A160		
5	Replacement long-life filter		KAF5511D160		
6	Replacement long-life filter (Auto grille panel)		KAF5512D160		
7	Branch duct chamber		KDJP55C80	KDJP55C160	
8	Insulation kit for high humidity <sup>10</sup>		KDTP55K80B	KDTP55K160B	

### Round Flow Cassette with Sensing Type



No.	Type		FXFSQ25A FXFSQ32A FXFSQ40A	FXFSQ50A FXFSQ63A FXFSQ80A	FXFSQ100A FXFSQ125A FXFSQ140A
	Item				
1	Decoration panel	Standard panel with sensing	Fresh white	BYCQ125EEF	
			Black	BYCQ125EEK	
		Standard panel	Fresh white	BYCQ125EAF *	
			Black	BYCQ125EAK *	
		Auto grille panel <sup>1,2</sup>	Fresh white	BYCQ125EBSF *	
2	Sealing material of air discharge outlet <sup>3</sup>		For usage of 3-, 4-way flow	KDBH551C160	
			For usage of 2-way flow	KDBH552C160	
3	Panel spacer		KDB55160F		
4	Fresh air intake kit	Chamber type <sup>4,5</sup>	Without T-duct joint	KDDP55C160 (Components: KDDP55C160-1, KDDP55C160-2) <sup>7</sup>	
			With T-duct joint	KDDP55C160K (Components: KDDP55C160-1, KDDP55C160K2) <sup>7</sup>	
		Direct installation type <sup>6</sup>	KDDP55X160A		
5	High-efficiency filter unit <sup>8</sup> (Including filter chamber)	(Colorimetric method 65%)	KAF556D80	KAF556D160	
		(Colorimetric method 90%)	KAF557D80	KAF557D160	
6	Replacement high-efficiency filter <sup>8,9</sup>	(Colorimetric method 65%)	KAF552D80	KAF552D160	
		(Colorimetric method 90%)	KAF553D80	KAF553D160	
7	Filter chamber		KDDFP55C160		
8	High performance prefilter (MERV 8) <sup>8</sup>		BAF552A160		
9	Replacement long-life filter		KAF5511D160		
10	Replacement long-life filter (Auto grille panel)		KAF5512D160		
11	Ultra long-life filter unit (Including filter chamber) <sup>8</sup>		KAF555D160		
12	Replacement ultra long-life filter <sup>8,9</sup>		KAF550D160		
13	Branch duct chamber <sup>3</sup>		KDJP55C80	KDJP55C160	
14	Insulation kit for high humidity <sup>8,10</sup>		KDTP55K80B	KDTP55K160B	

- Notes: 1. A dedicated wireless remote controller for the auto grille panel is included for lowering and raising the suction grille.  
 2. When installing auto grille panel, body height (ceiling required dimension) is 55 mm higher than standard panel.  
 3. Circulation airflow is not available with this option.  
 4. When installing a fresh air intake kit (chamber type), two air outlet corners are closed.  
 5. It is recommended that the volume of outdoor air introduced through the kit is limited to 10% of the maximum airflow rate of the indoor unit. Introducing higher quantities will increase the operating sound and may also influence temperature sensing.  
 6. The volume of fresh air for direct installation type is approximately 1% of the indoor unit airflow. The chamber type is recommended when more fresh air is necessary.  
 7. Please order using the names of both components instead of set name.  
 8. This option cannot be installed auto grille panel.  
 9. Filter chamber is required.  
 10. Please use in case temperature/humidity inside ceiling may get over 30°C, 80% RH.  
 \*These panels do not contain the sensing function.

# Option List

## VRV indoor units



### Round Flow Cassette Type

No.	Item	Type	FXFQ25A FXFQ32A FXFQ40A	FXFQ50A FXFQ63A FXFQ80A	FXFQ100A FXFQ125A FXFQ140A
1	Decoration panel	Standard panel	Fresh white	BYCQ125EAF *	
			Black	BYCQ125EAK *	
		Auto grille panel <sup>1,2</sup>	Fresh white	BYCQ125EBSF *	
2	Sealing material of air discharge outlet <sup>3</sup>	For usage of 3-, 4-way flow		KDBH551C160	
		For usage of 2-way flow		KDBH552C160	
3	Panel spacer			KDB551160F	
4	Fresh air intake kit	Chamber type <sup>4,5</sup>	Without T-duct joint	KDDP55C160 (Components: KDDP55C160-1, KDDP55C160-2) <sup>7</sup>	
			With T-duct joint	KDDP55C160K (Components: KDDP55C160-1, KDDP55C160K2) <sup>7</sup>	
		Direct installation type <sup>6</sup>		KDDP55X160A	
5	High-efficiency filter unit <sup>8</sup> (Including filter chamber)	(Colorimetric method 65%)	KAF556D80		KAF556D160
		(Colorimetric method 90%)	KAF557D80		KAF557D160
		(Colorimetric method 65%)	KAF552D80		KAF552D160
6	Replacement high-efficiency filter <sup>8,9</sup>	(Colorimetric method 65%)	KAF553D80		KAF553D160
		(Colorimetric method 90%)	KAF553D80		KAF553D160
7	Filter chamber		KDDFP55C160		
8	High performance prefilter (MERV 8) <sup>8</sup>		BAF552A160		
9	Replacement long-life filter		KAF5511D160		
10	Replacement long-life filter (Auto grille panel)		KAF5512D160		
11	Ultra long-life filter unit (Including filter chamber) <sup>8</sup>		KAF555D160		
12	Replacement ultra long-life filter <sup>8,9</sup>		KAF550D160		
13	Branch duct chamber <sup>3</sup>		KDJP55C80		KDJP55C160
14	Insulation kit for high humidity <sup>8,10</sup>		KDTP55K80B		KDTP55K160B

- Notes: 1. A dedicated wireless remote controller for the auto grille panel is included for lowering and raising the suction grille.  
 2. When installing auto grille panel, body height (ceiling required dimension) is 55 mm higher than standard panel.  
 3. Circulation airflow is not available with this option.  
 4. When installing a fresh air intake kit (chamber type), two air outlet corners are closed.  
 5. It is recommended that the volume of outdoor air introduced through the kit is limited to 10% of the maximum airflow rate of the indoor unit. Introducing higher quantities will increase the operating sound and may also influence temperature sensing.  
 6. The volume of fresh air for direct installation type is approximately 1% of the indoor unit airflow. The chamber type is recommended when more fresh air is necessary.  
 7. Please order using the names of both components instead of set name.  
 8. This option cannot be installed to auto grille panel.  
 9. Filter chamber is required.  
 10. Please use in case temperature/humidity inside ceiling may get over 30°C, 80% RH.  
 \*These panels do not contain the sensing function.

### Options of Round Flow Cassette with Sensing and Streamer & Round Flow Cassette with Sensing & Round Flow Cassette

#### Options required for specific operating environments

#### Ultra long-life filter unit

Even in dusty environments where the air conditioning is constantly operating, the ultra long-life filter only has to be cleaned once a year.

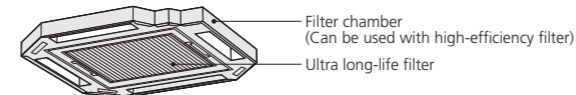

- Dusty area: annual filter change**  
 \*For dust concentration of 0.3 mg/m<sup>3</sup> (Requires separately sold Air purifier.)  
 1 year (Approx. 5,000 hr): About 15 hr/day x 28 day/month x 12 month/year  
**Ordinary store or office: filter change every 4 years**  
 \*For dust concentration of 0.15 mg/m<sup>3</sup>  
 4 years (Approx. 10,000 hr): About 8 hr/day x 25 day/month x 12 month/years x 4 years

#### High-efficiency filter unit

Available in two types: 65% and 90% colorimetry.

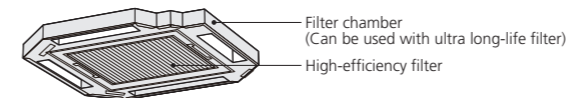

#### Insulation kit for high humidity

Please use if you think the temperature and humidity inside the ceiling exceeds 30°C and RH 80%, respectively.

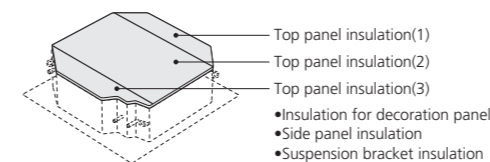

#### Panel spacer

Use when only minimal space is available between drop ceilings and ceiling slabs.

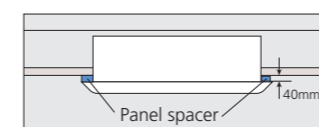

Note: Some ceiling constructions may hinder installation. Contact your Daikin Dealer before installing your unit.

#### Sealing material of air discharge outlet

By using this option, 2-way, 3-way, or 4-way flow can be selected.

#### Branch duct chamber

This chamber lets you connect a round flexible duct to the air discharge opening at any time after the original installation.

#### Fresh air intake kit <sup>1,2</sup>

Using this kit, a duct can be connected to take in outdoor air. There are two chamber types that have intake in two places: with T-duct joint and without T-duct joint.

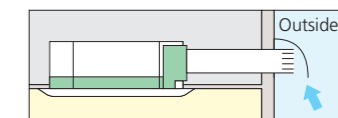

The units can be installed in the following different ways:

#### Chamber type (without T-duct joint) <sup>3, 4, 5</sup>

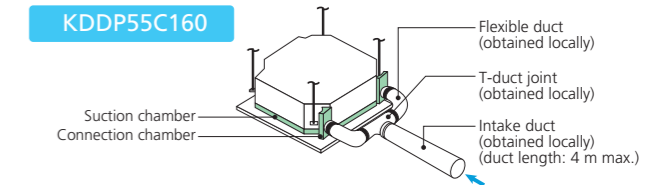

#### Chamber type (with T-duct joint) <sup>3, 4, 5</sup>

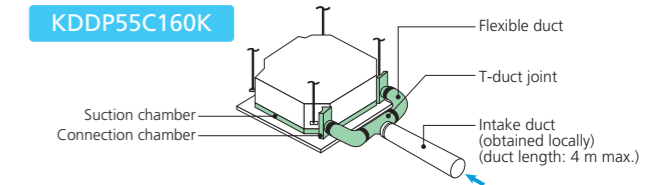

#### Direct installation type <sup>6</sup>

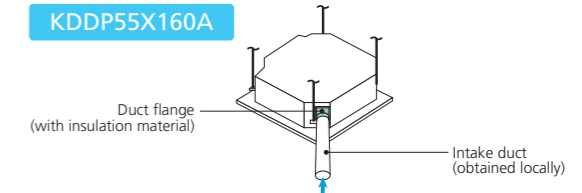

- Notes: 1. Use of options will increase operating sound.  
 2. Connecting ducts, fan, insect nets, fire dampers, air filters, and other parts should, as required, be obtained locally.  
 3. When a local-obtained fan is used, an interlock with air conditioner is necessary. Optional PCB (BRP11B62) is required for interlocking.  
 4. When installing a fresh air intake kit (chamber type), two air outlet corners are closed.  
 5. It is recommended that the volume of outdoor air introduced through the kit is limited to 10% of the maximum airflow rate of the indoor unit. Introducing higher quantities will increase the operating sound and may also influence temperature sensing.  
 6. The volume of fresh air for direct installation type is approximately 1% of the indoor unit airflow. The chamber type is recommended when more fresh air is necessary.

# Option List

## VRV indoor units

### High Performance Prefilter (MERV 8) Features and Benefits

#### MERV 8 Rating

This filter is a high performance prefilter that has achieved MERV 8 rating.

#### PM2.5 Filtration

This filter can catch fine particles that could not be removed by the existing prefilter, capturing 97% of 1.0-3.0 µm particles and 99% of 3.0-10 µm particles when air passes through filter 10 times.

#### Filter Exchange Twice a Year

Replace the filter twice a year in order to maintain the filter's high performance.

**BAF552A160**



#### Chamberless Filter

Additional parts and difficult installation works are unnecessary. Just replace the existing prefilter.

#### Retrofit to Existing Indoor Unit

Attachable to your current round flow cassette for IAQ improvement.

## Specifications

Model Name		BAF552A160		
Brand		DAIKIN		
Production Base		AAF Malaysia		
Performance		MERV 8		
Dimensions	mm	526 x 523 x 35		
Airflow rate	m <sup>3</sup> /min	13.0	22.9	37.0
Initial Pressure Drop*2	Pa	18.1	35.8	81.4
Weight	g	520		
Lifetime *3		6 months (1,250 hours)		
Reuse		Non-reusable		

Note 1. It is necessary to set a high ceiling mode on site to prevent a decrease in air volume when installing the filter. The setting number differs according to each model. Please refer to the installation manual.

\*2. This result is based on the test of the filter only. The results may be different in the actual use environment where the filter is installed in the indoor unit.

\*3. Filter lifetime may vary depending on the condition of the operating environment. Certain instances such as high traffic areas, pets or smokers in a residence, or other situations may require more frequent changes.

## Easy Replacement

The existing prefilter can be replaced easily\*. Since it's a chamberless filter, the installer will remove the existing prefilter and replace it with the high performance prefilter.

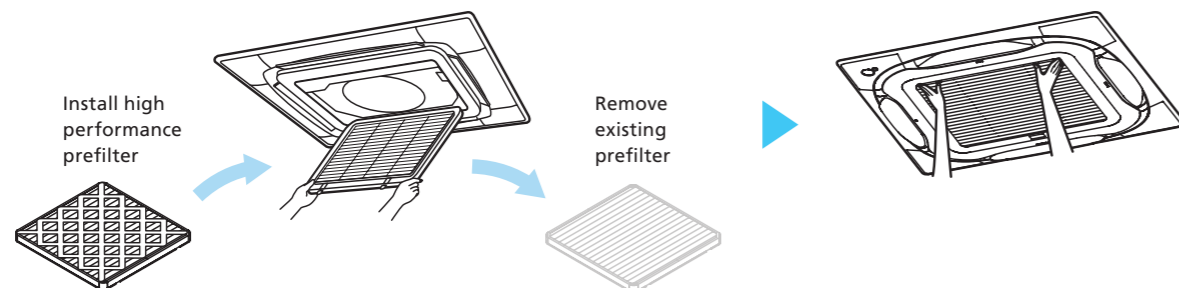

### Compact Multi Flow Cassette Type

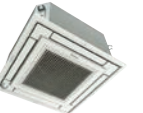

No.	Item	Type	FXZQ20A	FXZQ25A	FXZQ32A	FXZQ40A	FXZQ50A
1-1	Grid ceiling panel				BYFQ60CAW		
1-2	Sensor kit for grid ceiling panel				BRYQ60AAW		
1-3	Sealing material of air discharge outlet for grid ceiling panel				BDBHQ44C60		
2	Replacement long life filter				KAF441C60		
3	Fresh air intake kit				KDDQ44XA60		
4	Streamer filter clean unit *2				BAPWS55A61		

Note: Available only when stylish remote controller (BRC1H63W/K) is connected.

### Double Flow Cassette Type

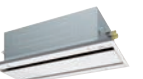

No.	Item	Model	FXCQ20A	FXCQ25A	FXCQ32A	FXCQ40A	FXCQ50A	FXCQ63A	FXCQ80A	FXCQ125A
1	Decoration panel			BYBCQ40CF			BYBCQ63CF		BYBCQ125CF	
2	High efficiency filter *1	65 %		KAF532C50			KAF532C80		KAF532C160	
		90 %		KAF533C50			KAF533C80		KAF533C160	
3	Filter chamber for bottom suction			KDDFP53B50			KDDFP53B80		KDDFP53B160	
4	Long life replacement filter			KAF531C50			KAF531C80		KAF531C160	
5	Streamer filter clean unit *2									BAPWS55A61

Notes: \*1. If installing high efficiency filter, filter chamber is required.  
\*2. Available only when stylish remote controller (BRC1H63W/K) is connected.

### Single Flow Cassette Type



No.	Item	Type	FXEQ20A FXEQ25A	FXEQ32A FXEQ40A	FXEQ50A FXEQ63A
1	Decoration panel		BYEP40AW1		BYEP63AW1

### Slim Duct (Standard) Type



No.	Item	Type	FXDQ20PD	FXDQ25PD	FXDQ32PD	FXDQ40ND	FXDQ50ND	FXDQ63ND
1	Insulation kit for high humidity			KDT25N32			KDT25N50	KDT25N63

### Slim Duct (Compact) Type



No.	Item	Model	FXDQ20T	FXDQ25T	FXDQ32T	FXDQ40T	FXDQ50T	FXDQ63T
1	3-D Auto swing discharge grille			BDG20A09			BDG20A15	BDG20A20
2	Auto clean air filter module			BAE20A62			BAE20A82	BAE20A102

### Middle Static Pressure Duct Type



No.	Item	Type	FXSQ20PA FXSQ25PA FXSQ32PA	FXSQ40PA	FXSQ50PA	FXSQ63PA FXSQ80PA	FXSQ100PA FXSQ125PA	FXSQ140PA
1	High efficiency filter *1	65%	KAF632C36	KAF632C56		KAF632C80	KAF632C160	KAF632B160B
		90%	KAF633C36	KAF633C56		KAF633C80	KAF633C160	KAF633B160B
2	Filter chamber (for rear suction) *1		KDDFP63B36	KDDFP63B56		KDDFP63B80	KDDFP63B160	KDDF63B160B
3	Long-life filter *1		KAF631C36	KAF631C56		KAF631C80	KAF631C160	KAF631B160B
4	Service panel (Fresh white)		KTBJ25K36F	KTBJ25K56F		KTBJ25K80F		KTBJ25K160F
5	Air discharge adaptor		KDAP25A36A	KDAP25A56A		KDAP25A71A	KDAP25A140A	KDAP25A160A *2
6	Shield plate for side plate						KDBD63A160	—

Notes: \*1. If installing high efficiency filter and long-life filter to the unit, filter chamber is required.  
\*2. This option is a set of KDAP25A140A and KDBHP37A160.



# Option List

## VRV indoor units

### Middle Static Pressure Duct Type



No.	Item	Model	FXDYQ80MA	FXDYQ100MA	FXDYQ125MA	FXDYQ145MA
1	Run/fault status PCB					KRP1B5X

### Middle-High Static Pressure Duct Type



No.	Item	Type	FXMQ20PA FXMQ25PA FXMQ32PA	FXMQ40PA	FXMQ50PA FXMQ63PA	FXMQ80PA	FXMQ100PA FXMQ125PA FXMQ140PA
			1	High efficiency filter	65% 90%	KAF372AA36 -	KAF372B56 KAF373B56
2	Filter chamber		-	KDDF37AB56	KDDF37AB80	KDDF37AB160	
3	Long life replacement filter		-	KAF371B56	KAF371B80	KAF371B160	
4	Long life filter chamber kit		-	KAF375C56	KAF375C80	KAF375C160	
5	Service panel (Fresh white)		KTBJ25K36F	KTBJ25K56F	KTBJ25K80F	KTBJ25K160F	
6	Air discharge adaptor		KDAJ25K36A	KDAJ25K56A	KDAJ25K71A	KDAJ25K140A	

### High Static Pressure Duct Type



No.	Item	Type	FXMQ160P	FXMQ180P	FXMQ200P	FXMQ250P
1	Drain pump kit					BDU37A250

### 4-Way Flow Ceiling Suspended Type



No.	Item	Type	FXUQ71A	FXUQ100A
1	Sealing material of air discharge outlet			KDBHP49B140
2	Decoration panel for air discharge			KDBTP49B140
3	Replacement long-life filter			KAF5511D160

### Ceiling Suspended Type



No.	Item	Type	FXHQ32MA	FXHQ50MA	FXHQ63MA	FXHQ80MA	FXHQ100MA	FXHQ125B	FXHQ140B
1	Drain pump kit		KDU50N60VE		KDU50N125VE		KDU50P160		
2	Replacement long-life filter		KAFJ501D56	KAFJ501D80	KAFJ501D112		KAF501B160		
3	L-type piping kit (for upward direction)		KHFP5M63		KHFP5M160		KHFP5N160		
4-1	Streamer filter clean unit <sup>*1,2</sup>						BAPWS55A61		
4-2	Mounting kit for streamer option						BERPW50A61		

Notes: \*1. Mounting kit for streamer option (BERPW50A61) is necessary.  
\*2. Available only when stylish remote controller (BRC1H63W/K) is connected.

### Wall Mounted Type



No.	Item	Type	FXAQ20A	FXAQ25A	FXAQ32A	FXAQ40A	FXAQ50A	FXAQ63A
1	Drain pump kit		K-KDU572KVE					
2	External EV kit (for heating operation)*1		BEV15D			BEV30D		

Note: \*1. This option is only effective for reducing operation sound during heating operation. Therefore it is ineffective when connected to cooling only outdoor units.

### Floor Standing Type



No.	Item	Type	FXLQ20MA	FXLQ25MA	FXLQ32MA	FXLQ40MA	FXLQ50MA	FXLQ63MA
1	Long life replacement filter		KAF361L28		KAF361L45		KAF361L71	

### Concealed Floor Standing Type



No.	Item	Type	FXNQ20MA	FXNQ25MA	FXNQ32MA	FXNQ40MA	FXNQ50MA	FXNQ63MA
1	Long life replacement filter		KAF361L28		KAF361L45		KAF361L71	

# Option List

## BS Units for Heat Recovery

### Single BS Unit



No.	Item	Type	BSQ100A	BSQ160A	BSQ250A
1	Quiet kit			KDDN26A1	
2	External control adaptor for outdoor units			DTA104A61	
3	Adaptor for multi tenant			DTA114A61	

### Multi BS Unit



No.	Item	Type	BS4Q14B	BS6Q14B	BS8Q14B	BS10Q14B	BS12Q14B	BS16Q14A
1	Closed pipe kit		KHFP26A100C					
2	Joint kit		KHRP26A250T					
3	Quiet kit		KDDN26C4	KDDN26C8		KDDN26C12		KDDN26B16

## Header Pack

No.	Item	Type	4 port type	6 port type
1	HEADER PACK		BHF6RHP6Z	BHF6ARHP6Z, BHF8RHP6Z, BHF10RHP6Z, BHF16RHP6Z

## Control systems

### Operation control system optional accessories



Remote sensor  
BRC501A-1(4)(5)(6)

#### For VRV indoor unit use

No.	Item	Type	FXFTQ-A	FXFSQ-A	FXFQ-A	FXZQ-B	FXCQ-B	FXEQ-A	FXDO-PD FXDQ-ND	FXDQ-T	FXSQ-PA		
1	Stylish remote controller *5		BRC1H63W (White) / BRC1H63K (Black)										
2	*"Nav Ease" remote controller *5		BRC1E63										
3	Simplified remote controller		BRC2E61										
4	Wireless remote controller		BRC7M634F (Fresh White) BRC7M634K (Black)		BRC7M530W	BRC7M65	BRC4M61	BRC4C65					
5-1	Adaptor for wiring (operation status output)		*BRP11B62				—		*BRP11B61	—			
5-2	Adaptor for wiring		—				*KRP1C14A	—		*KRP1C64	—		
6-1	Wiring adaptor for electrical appendices (1)		—		*KRP2A62	*KRP2A51	—		*KRP2A53	*KRP2A61			
6-2	Wiring adaptor for electrical appendices (2)		*KRP4AA53				*KRP4AA51	—		*KRP4A54	*KRP4AA51		
7	Remote sensor (for indoor temperature)		BRC501A-5			BRC501A-6		BRC501A-4	BRC501A-1	BRC501A-4			
8	Installation box for adaptor PCB		KRP1H98A *2,3		KRP1BB101 *4	KRP1C96 *2,3	—		KRP1BB101 *4	BRP9A90	KRP4A98 *2,3		
9	External control adaptor for outdoor unit		*DTA104A62				*DTA104A61	—		*DTA104A53	*DTA104A61		
10	Adaptor for multi tenant		—				*DTA114A61	—					
11	Multi tenancy kit		—								KRP114A3 *2	—	
12	Digital input adaptor		*BRP7A52			*BRP7A53	*BRP7A51	—		*BRP7A54	*BRP7A51		

No.	Item	Type	FXDYQ-MA	FXMQ-PA	FXMQ-P	FXUQ-A	FXHQ-MA	FXHQ-B	FXAQ-A	FXLQ-MA FXNQ-MA		
1	Stylish remote controller *5		BRC1H63W (White) / BRC1H63K (Black)									
2	*"Nav Ease" remote controller *5		BRC1E63									
3	Simplified remote controller		BRC2E61									
4	Wireless remote controller		BRC4C62	BRC4C65			BRC7CB58	BRC7EA63W	BRC7M53	BRC7M675	BRC4C62	
5-1	Adaptor for wiring (operation status output)		—		*BRP11B62	—		*BRP11B61	BRP11B61-1	—		
5-2	Adaptor for wiring		KRP1B61	—		*KRP1C67	—					
6-1	Wiring adaptor for electrical appendices (1)		KRP2A61	*KRP2A61	*KRP2A62	—		*KRP2A62	—		*KRP2A61	
6-2	Wiring adaptor for electrical appendices (2)		KRP4AA51	*KRP4AA51	*KRP4AA52	*KRP4AA53	*KRP4AA52		*KRP4AA51	KRP4AA51		
7	Remote sensor (for indoor temperature)		BRC501A-1			BRC501A-4		BRC501A-1				
8	Installation box for adaptor PCB		—		KRP4A97 *2,3	BRP9A90	KRP1BA97	KRP1CA93 *3	KRP1D93A *3	KRP4B93 *2,3	—	
9	External control adaptor for outdoor unit		DTA104A61	*DTA104A61	—			*DTA104A62		*DTA104A61	DTA104A61	
10	Adaptor for multi tenant		*DTA114A61									
11	Digital input adaptor		BRP7A52	*BRP7A51	*BRP7A52	*BRP7A53	*BRP7A52		*BRP7A51	BRP7A51		

- Notes: 1. Installation box \*8 is necessary for each adaptor marked \*.  
 2. Up to 2 adaptors can be fixed for each installation box.  
 3. Only one installation box can be installed for each indoor unit.  
 4. Up to 2 installation boxes can be installed for each indoor unit.  
 5. Some functions can be set only via the stylish or "Nav Ease" remote controller. They cannot be set via other remote controllers. Please refer to each indoor unit and remote controller page for function details.  
 6. Since the control panel is equipped as standard, use the option of BRC1E63 for 2 remote control system.

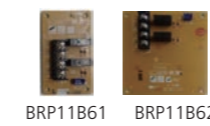

BRP11B61 BRP11B62

### Adaptor for wiring (operation status output)

By installing it in the indoor unit with a simple wire connection, this adaptor takes out the operating signals for the indoor unit fan and the compressor and enables the interlocking of equipment such as the ventilation fan.

Example:  
Interlocking operation of the indoor unit and ventilation fan that takes in fresh air.

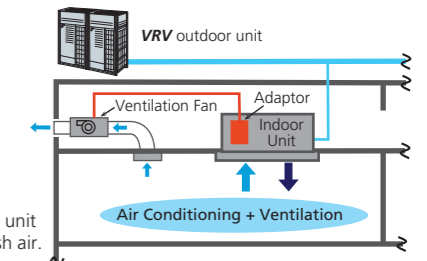

# Option List

## System configuration

No.	Item	Model No.	Function
1	Residential central remote controller	DCS303A51 *2	• Up to 16 groups of indoor units (128 units) can be easily controlled using the large LCD panel. ON/OFF, temperature settings and scheduling can be controlled individually for indoor units.
2	Interface adaptor for SkyAir-series	★DTA112BA51 *3	• Adaptors required to connect products other than those of the <b>VRV</b> System to the high-speed DIII-NET communication system adopted for the <b>VRV</b> System. * To use any of the above optional controllers, an appropriate adaptor must be installed on the product unit to be controlled.
3	Central control adaptor kit   For UAT(Y)-K(A),FD-K	★DTA107A55	
4	Wiring adaptor for other air-conditioner	★DTA103A51	
5	DIII-NET expander adaptor	DTA109A51 + BER11A *4	
5-1	External control adaptor	DTA104A62	• Demand control of individual or multiple systems. • Low noise option for individual or multiple systems.

- Notes: 1. Installation box for ★ adaptor must be obtained locally.  
2. For residential use only. Cannot be used with other centralised control equipment.  
3. No adaptor is required for some indoor units.  
4. BER11A is necessary when connecting DTA109A51 to the main PCB (**VRV** R/H).

## Building management system

No.	Item		Model No.	Function			
1	intelligent Touch Controller	Basic	Hardware	intelligent Touch Controller	DCS601C51	• Air-Conditioning management system that can be controlled by a compact all-in-one unit.	
1-1			Hardware	DIII-NET plus adaptor	DCS601A52	• Additional 64 groups (10 outdoor units) is possible.	
1-2		Option	Software	Web software	DCS004A51	• <b>VRV</b> system that is connected to intelligent Touch Controller can be operated from the user's PC via a web page.	
1-3	Electrical box with earth terminal (4 blocks)			KJB411A	• Wall embedded switch box.		
2	intelligent Touch Manager	Basic	Hardware	intelligent Touch Manager	DCM601B51	• Air-conditioning management system that can be controlled by touch screen.	
2-1				DIII plus adaptor	DGE601A52	• Additional 64 groups (10 outdoor units) is possible. DIII plus adaptor and Max. 6 DIII plus adaptor slots can be connected to intelligent Touch Manager.	
2-2				DIII plus adaptor slot	DGE601A53		
2-3		Option	Software	iTM power proportional distribution	DCM002A51	• Power consumption of indoor units are calculated based on operation status of the indoor unit and outdoor unit power consumption measured by kWh metre.	
2-4				iTM energy navigator	DCM008A51	• Building energy consumption is visualised. Wasted air-conditioning energy can be found out.	
2-5				BACnet® client	DCM009A51	• BACnet® equipment can be managed by intelligent Touch Manager.	
2-6				HTTP Interface	DCM007A51	• Interface for intelligent Touch Manager by HTTP	
2-7		Basic	Hardware	<b>Reiri</b> for Office	DCPF01	• <b>VRV</b> smart controller (website or mobile app via smart phone or tablet) for small to medium scale building	
2-8				<b>Reiri</b> for Office (Touchscreen Controller)	DCPF04-AU *1	• <b>VRV</b> smart controller with touch panel (website or mobile app via smartphone or tablet) for small to medium scale building	
2-9				<b>Reiri</b> for Office (Controller Extension)	DCPF05	• <b>VRV</b> smart controller for large scale building	
2-10	<b>Reiri</b> for Office (Multisite Extension)			DCPF10	• Control all <b>VRV</b> units via <b>Reiri</b> for Office on multisite		
2-11	<b>Reiri</b> for Home			DCPH01	• <b>VRV</b> smart home automation and smart control solution		
2-12	<b>Reiri</b> for Home (Lite Version)			DCPH02	• <b>VRV</b> smart centralised controller		
2-13	Smartphone/ Tablet control			Hardware	Adaptor for <b>Reiri</b>	DCPA01	• Interface adaptor for <b>Reiri</b>
2-14					Interface adaptor for <b>Reiri</b> with installation box	DCPA01B	
2-15				IAQ Sensor DC for <b>Reiri</b>	DCPE02S	• IAQ Sensor for <b>Reiri</b> (24V AC/DC)	
2-16				Option	Software (Commercial)	Commercial Automatic Control	DCPN001
2-17		Commercial Data Analytics	DCPN002			• Operation Report, Error Report; Trend Graph, Energy Graph functions for individual controller	
2-18		PPD & Tenant Billing Management	DCPN003			• Power Proportional Distribution and billing function for individual controller	
2-19		Realtime Energy Monitoring (REM)	DCPN004			• Real Time Energy Display function for individual controller	
2-20		Multisite Branch Expansion	DCPN005			• To expand the multisite control limit by 1 site	
2-21	iTM Tenant Billing Management	DCPN008	• Billing function for iTM Power Proportional Distribution data				
2-22	Software (Residential)	Residential Automatic Control	Residential Automatic Control	DCPN006	• Setback, Setpoint Range, Remote Control Prohibition, Automatic Changeover functions for individual controller		
2-23			Residential System Report	DCPN007	• Operation Report, Error Report functions for individual controller		
2-24	Di unit			DEC101A51	• 8 pairs based on a pair of ON/OFF input and abnormality input.		
2-25	Dio unit			DEC102A51	• 4 pairs based on a pair of ON/OFF input and abnormality input/output.		
3	Communication interface	Interface for use in BACnet® *2		DMS502B51	• Interface unit to allow communications between <b>VRV</b> and BMS. Operation and monitoring of air-conditioning systems through BACnet® communication.		
3-1		Optional DIII board		DAM411B51	• Expansion kit, installed on DMS502B51, to provide 2 more DIII-NET communication ports. Not usable independently.		
3-2		Optional Di board		DAM412B51	• Expansion kit, installed on DMS502B51, to provide 16 more wattmeter pulse input points. Not usable independently.		
4		Interface for use in LONWORKS® *3		DMS504B51	• Interface unit to allow communications between <b>VRV</b> and BMS. Operation and monitoring of air-conditioning systems through LonWorks® communication.		
5		Modbus® Communication Adaptor		DTA116A51	• Use of the Modbus® protocol enables the connection of the <b>VRV</b> system with a variety of home automation systems from other manufacturers. *5		
6	Contact/ analogue signal	Unification adaptor for computerised control		★DCS302A52	• Interface between the central monitoring board and central control units.		

- Notes: \*1. **Reiri** for Office (Touchscreen Controller) DCPF04-AU includes built-in Commercial Automatic Control functions (Set back, Scene, Interlock Automatic Changeover).  
\*2. BACnet® is a registered trademark of American Society of Heating, Refrigerating and Air-Conditioning Engineers (ASHRAE).  
\*3. LonWorks® is a trademark of Echelon Corporation registered in the United States and other countries.  
\*4. Installation box for ★ adaptor must be obtained locally.  
\*5. Modbus® is a registered trademark of Schneider Electric S.A.



# Engineering Supports

## Design assistance and sales proposal

By providing not only excellent products but also engineering software, Daikin helps consultants and architects select **VRV** systems more appropriately and easily to enable more efficient operation and function, and then supports the optimisation of the environment (space) where **VRV** systems exist.

Model Selection

Drawing Supports

Analysis and Simulation

### Model Selection

## VRV Xpress

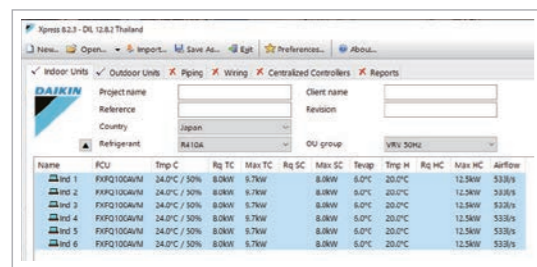

### Model Selection

- Refrigerant charge calculation

#### Standard VRV model selection software

The optimum system is automatically selected just by inputting the design conditions. Refrigerant piping and additional refrigerant charge amount are automatically selected. In addition, it supports the preparation of a quotation.

### Drawing Supports

## 3D Revit data / 2D CAD symbol

Revit data is used in BIM. It includes not only 3D CAD data but also device specification data such as airflow rate and capacity. Daikin also provides symbol data compatible with 2D CAD.

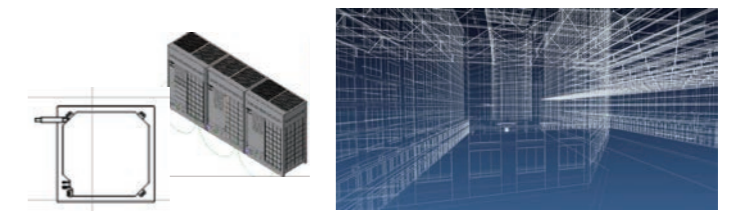

### Analysis and Simulation

## DT-FLOW2 (Airflow simulation)

### ■ IEQ simulation

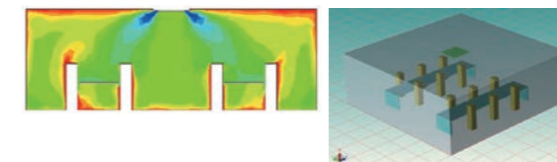

#### Indoor air environment analysis software

Simulates temperature and humidity, CO<sub>2</sub>, dust, and air age. Creates model of the property with Filder Cube (equipment CAD software), calculates with IconCFD (analysis software), and automatically outputs the report.

### ■ Outdoor airflow simulation

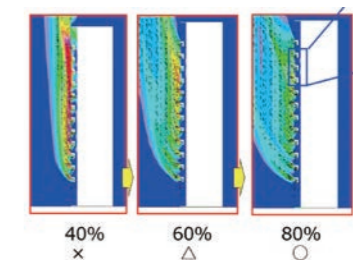

#### Outdoor airflow analysis software

Simulates the short circuit of the outdoor unit and uses it as a reference for optimal installation. Creates model of the property with Filder Cube (equipment CAD software), calculates with IconCFD (analysis software), and automatically outputs the report.

## Ventilation Xpress

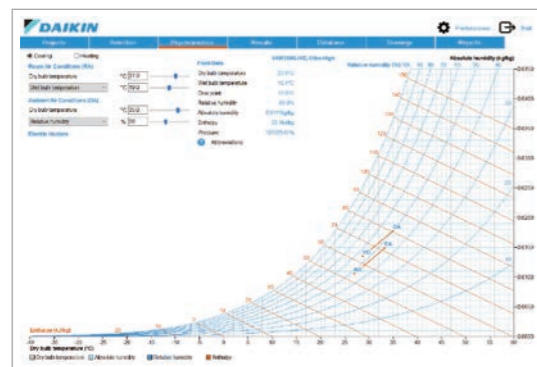

### Model Selection for ventilation products

#### Ventilation products selection software

Heat Reclaim Ventilator (VAM series) or Outdoor Air Processing Unit (OAPU) can be selected by inputting conditions such as ventilation volume and external static pressure. In addition, the air temperature and humidity conditions at each point of the selected system are displayed on the psychrometric chart.



**Warning**



- Ask a qualified installer or contractor to install this product. Do not try to install the product yourself. Improper installation can result in water or refrigerant leakage, electrical shock, fire or explosion.
- Use only those parts and accessories supplied or specified by Daikin. Ask a qualified installer or contractor to install those parts and accessories. Use of unauthorised parts and accessories or improper installation of parts and accessories can result in water or refrigerant leakage, electrical shock, fire or explosion.
- Read the user's manual carefully before using this product. The user's manual provides important safety instructions and warnings. Be sure to follow these instructions and warnings.

**Notice**



- About harmonics, since this product is equipped with an inverter, harmonics will be generated. If local laws require the suppression of harmonics on the building, please take harmonic suppression measures on the electrical equipment side. Please contact your local sales company for details.

If you have any enquiries, please contact your local importer, distributor and/or retailer.

### **Cautions on product corrosion**

1. Air conditioners should not be installed in areas where corrosive gases, such as acid gas or alkaline gas, are produced.
2. If the outdoor unit is to be installed close to the sea shore, direct exposure to the sea breeze should be avoided. If you need to install the outdoor unit close to the sea shore, contact your local distributor.

**VRV** is a trademark of Daikin Industries, Ltd.

**VRV** Air Conditioning System is the world's first individual air conditioning system with variable refrigerant flow control and was commercialised by Daikin in 1982.

**VRV** is the trademark of Daikin Industries, Ltd., which is derived from the technology we call "variable refrigerant volume."